

Coach Light Has The Discount Priced Christmas Gifts — Compare and Save

QUARTZ CLOCK
PORTABLE 2 1/2" BLACK & WHITE TELEVISION/AM/FM RADIO WITH LCD QUARTZ CLOCK

- 2 1/2" Portable AC/DC B&W Television
- AM/FM Radio
- LCD Digital Quartz Alarm Clock

329.95 Value **\$299.95**

RM5011
AM/FM DIGITAL CLOCK RADIO

- Large, Lighted Flip-Type Numerals
- 60 Minute Sleep Timer
- 24-Hour Wake-up Memory
- Earphone or Pillow Speaker Jack
- Wake to Music or Buzzer

37.95 Value **\$27.88**

M2555
AM/FM CASSETTE RECORDER with SLIDE RULE DIAL AND VARIABLE MONITOR

- Deluxe Styling
- Slide Rule Tuning Dial
- 1900mW Output Power
- Calibrated Volume Control

864.95 Value **\$48.88**

LITTLE GALLERY by Hallmark

Ring a song of Christmas.

Hallmark designer Mary Hamilton tops Little Gallery's first dated Christmas bell with a drummer boy. Begin a tradition with a full lead crystal gift that says you care. Gift boxed, \$34.00.

Plush Animals

Wide Selection Priced For Every Christmas Budget

Timex Watches

100's to Choose From Cheerfully Exchanged If Their Choice Is Not Your Choice

Qualify for nationals 2 Snover girls win 4-H honors

Two Lucky Stars 4-H Club members of Snover have earned top state honors for their 4-H projects and will be going to the 58th National 4-H Congress in Chicago Nov. 25-29.

Dawn won the state 4-H swine award. In her ninth year of 4-H, she has earned a net profit of \$2,819 with her hogs. Earlier this year, she was named to the state 4-H Livestock Developmenta.



Debbie Mahaffy



Dawn Adam

They are Debbie Mahaffy, 18, daughter of Irvin and Aletha Mahaffy of Germania Road and Dawn Adam, 17, daughter of Wayne and Faye Adam of W. Snover Road.

Debbie was state winner in personal appearance-fashion revue. The nine-year 4-H'er has also been involved in the following project areas: Beef, swine, crafts, food and nutrition, cake decorating, indoor gardening, flower gardening, vegetable gardening, knitting, crocheting and sewing.

She has been a 4-H junior leader, Sanilac county 4-H queen (1976-77) and was crowned Sanilac County Bean Queen at this year's county fair.

She is a 4-H junior leader and was crowned Sanilac County 4-H Queen at this year's fair.

A freshman at Central Michigan University, she plans to earn a degree in business administration.

Insurance hot line now open

RLDS ladies

appoint

officers

The Owendale Reorganized Church of Jesus Christ of Latter Day Saints Women's Department met at the home of Mrs. Geneva Richards, Cass City, for worship and business.

The toll-free telephone number is 1-800-292-0712. It will be listed in the yellow pages of new area telephone directories, scheduled for distribution during February.

Thirteen members and one guest, Mrs. Leann Rogers, were present. Mrs. Richards read "Strangers in a Strange Land" and "Heritage" from the "Ideals" book on Thanksgiving. The ladies joined together in singing "We Gather Together to Ask the Lord's Blessing." Prayer was offered by Mrs. Dolores Gardner.

The service is designed to give consumers quick access to information on automobile and homeowners insurance, plus other property-casualty coverages. Residents can also get assistance when they have problems with their own insurance company.

Mrs. Darlene Kuenzli, women's leader, conducted the business meeting for election of officers for the 1980 year. The assistant leader, Charlene Craig, was appointed by the leader with approval by the ladies. Vickie Merchant was elected secretary. Treasurer is Connie Dubs.

The hotline is open weekdays, 8:30 a.m.-4:30 p.m. It is sponsored by Michigan Association of Insurance Companies (MAIC), a non-profit public affairs organization representing Michigan property-casualty insurers. The association is headquartered in Lansing.

Cheer committee chairman is Dolores Gardner. Last year's committee was sustained for this year: Geneva Richards, Ila McCallum, and Charlene Craig. Publicity is Lucille Wells.

If hotline personnel can't provide information or solve a problem on the spot, they get in touch with the consumer's insurance company. The Hotline doesn't sell insurance. "We don't even recommend which company someone should buy from, nor will we tell them what type of coverage to buy," according to MAIC President Terry Buckles.

Dining room hostess chairman is Ardis Gemmell, and her committee: Connie Dubs, Geneva Richards, Dolores Gardner and Lucille Wells.

Buckles emphasized that consumers should first contact their own insurance agent or company representative in attempting to solve problems. "If that's not possible, or if the person is not satisfied, we would like the chance to help," he concluded.

Kitchen committee chairman is Reva Russell, and her committee: Madelyn Ziehm and Evelyn Haley. Supply chairman is Evelyn Haley.

Any car will last a lifetime if you're careless enough.

Other business was: reading of minutes by Lucille Wells and treasurer's report by Connie Dubs. A work night on bazaar items was scheduled for Monday night from 6-10 p.m. at Darlene Kuenzli's.

RENT RINSEVAC
 the professional do-it-yourself carpet cleaning system

SPECIAL RENTAL RATE OFFER

NOW ONLY **3⁹⁹** HALF DAY

RINSEVAC cleans the way professionals do, at a fraction of the cost!

Albee Home Center
 Cass City

Two to remember

KODAK INSTAMATIC X-15F Camera Outfit

- Aim-and-shoot simplicity
- No focusing
- Simple drop-in film loading includes film and flash

\$18.95

Kodak PR 10 Film

7.95 Value **\$6.76**

These Books Entertain The Kids

Fill kids' long winter days with games, mazes, stickers and other fun! Activity Books, \$1.75.

HOLIDAY FUN Activity Book

© 1979 Hallmark Cards, Inc.

It's time To Decorate!

Show off your tree — and your good taste — with shiny-bright ornaments of satin or glass, from Hallmark. \$3.50.

© 1979 Hallmark Cards, Inc.

Kodak Ektralite 10 Camera Outfit

Reg. \$99.95 **\$88.95**

Congratulations To Mary Sherrard
 Cass City Winner Of Our Free Turkey

Kodak 350

A Christmas Book For Baby

Share Christmas joy with your favorite small angel. Give "Baby's First Book About Christmas." Just \$2.50.

© 1979 Hallmark Cards, Inc.

MERLIN

THE ELECTRONIC WIZARD!

Merlin's computer brain counters your moves, boggles your mind.

PARKER BROTHERS MERLIN:

Six electronic games with sound from Tic-Tac-Toe to Blackjack 13. Even plays music.

Reg. \$31.99 **27⁹⁷** each

COLOR BURST CAMERA

Reg. 76.50 **\$61.20**

Gift Wrap
 3 Rolls - 3 Designs

100 sq. ft. 2.99 Value **\$1.96**

35 INDOOR - OUTDOOR Mini Lights

5.95 Value **\$3.19**

Any Size **CIGARETTES** Ctn. **\$4.62**

Plus Tax

Register for **FREE TRIP to FLORIDA**

OPEN SUNDAY 1-5 p.m. Avoid the Crowds

FREE SUNDAY COFFEE TICKETS

Lay Away for Christmas

Register For **Lucky Bucks Contest**

Authorized Thumb Distributor For Hollister Ostomy Products

COACH LIGHT PHARMACY
 MIKE WEAVER, Owner Ph. 872-3613
 Emergency Ph. 872-3283
 Your Family Discount Drug Store

We Accept All Pre-Pay Prescription Plans

Writing workshop set Nov. 28 for teachers

Wednesday, Nov. 28, from 5-8 p.m. there will be a workshop to help teachers learn more about the teaching of creative writing in their classrooms.

Speaker will be Jerry Palmer from Oakland University. She is an assistant to Dr. Harry Hahn at Oakland and has taught language encounter classes for the past five years. She has conducted writing conferences in the summers, and has participated in the last five young authors' conferences held at Oakland. The conference will take place in the Cass City Intermediate School cafeteria.

Registration fee is \$1, payable to Thumb Area Reading Council and sent to Elizabeth Shelton, Millington Community Schools, Millington 48746, by Nov. 26. Teachers should bring their own sack dinner.



WOMAN OF THE YEAR -- Holding the engraved platter she received for the honor from the Cass City Business and Professional Women's Club is Genevieve Freiburger. Others, from left, are Mardell Ware, Thelma Pratt and Gerry Fischer, members of the selection committee for the honor, and Mable Wright, local chapter president.

The weather

	High	Low	Precip.
Wednesday	44	20	0
Thursday	38	12	0
Friday	42	28	.13
Saturday	58	24	0
Sunday	68	34	0
Monday	68	38	0
Tuesday			.03

(Recorded at Cass City wastewater treatment plant)

STRAND - CARO

Phone 673 3033

Two Admitted For \$2.50 on Mon. and Tues.

Fri. thru Thurs. Nov. 23 - 29
See Burt Reynolds' Newest Hit!
Fri. and Sat. Feature @ 7:25 and 9:30
Sunday Feature @ 3:07-5:14-7:20-9:25
Mon. thru Thurs. Feature @ 7:17-9:24

BURT REYNOLDS
JILL CLAYBURGH **CANDICE BERGEN**

Phil Potter would like to straighten out his life... One way, or the other.

Starting Over

PG PARENTS STRONGLY CAUTIONED
R RESTRICTED
M MATURE AUDIENCES ONLY
TV TV PARENTS STRONGLY CAUTIONED
TV MA TV MATURE AUDIENCES ONLY

Coming... A Comedy Sensation!!

PETER FALK **ALAN ARKIN**

THE IN LAWS

PG PARENTS STRONGLY CAUTIONED
R RESTRICTED
M MATURE AUDIENCES ONLY
TV TV PARENTS STRONGLY CAUTIONED
TV MA TV MATURE AUDIENCES ONLY

Remember... Every Sunday Adults Only \$1.50
2:30 till 6:00! Come & Save!

Genevieve Freiburger 'woman of the year'

Genevieve Freiburger was honored by the Cass City Business and Professional Women's Club last Wednesday as its "Woman of the Year."

School, she taught school for two years prior to her marriage to Alger Freiburger and has since taught 25 years in the Owen-Gage school system. She and her husband have three sons and three daughters and two grandchildren and live at 6592 Third Street.

Relatives of Mrs. Freiburger who attended the dinner meeting at Veronica's Restaurant were her daughter Diane of Detroit and two sisters-in-law, Mrs. Irene Freeman and Mrs. Jacqueline Freiburger.

Other guests at the meeting were Ruth McConnell of Caro, district 11 director, and Della Hammond of LaPeer, assistant district director. For the program, Ruth McConnell showed slides and photographs she took at the BPW national convention in Boston. During the business meeting, plans were made for the Christmas party Dec. 5. The club will furnish a Christmas tree for the patio at Provincial House. Nineteen women attended the meeting.

PEDALING AROUND

Barbie is a gas

By Mike Eliasohn

"Look, mommie, look." "Look at Barbie." "She is getting into her new motor home. It gets only eight miles per gallon. She is driving it to the gasoline station. May I have some money, mommie, so I can buy Barbie some gasoline?"

have changed - that certain women. Well, the way I understood it when I was a kid, a woman might start by buying a dress. Then she would decide she needed new shoes to go with the dress, then a new purse, and then a new hat.

Now is a fascinating time to watch television commercials, because I get to find out about all the new toys the toy companies have invented since last Christmas. The honor, by the way, of having the first Christmas commercial on the air goes to the maker of a very old toy. Lionel Trains was promoting its products with Christmas mentioned by about mid-October. One advantage of being single, I might add, is that I don't have to put up with being nagged to buy the newest goodies. "Daddy, I want a new Sooper Scooper for Christmas."

That was, of course, when few women worked, so it was their husbands who had to pay for all that. I guess times have changed. Some women, it seems, go through life with one pair of blue jeans at a time. When the jeans wear out, they buy a new pair. All this leads up to the makers of Barbie Doll, who I guess are trying to revive the old tradition. Father and mother buy their daughter a Barbie Doll for Christmas, along with a couple of outfits to go with it.

For the first couple of years, it's maybe another outfit for daughter at Christmas and on her birthday. But then the daughter discovers girls go out with boys, so Barbie needs some more outfits to attract the boys.

Then Barbie needs a boyfriend. His name is Ken, who of course needs some outfits to help him attract the girls. When the daughter discovers some boys like football, Barbie will need a cheerleader's outfit and Ken will need a football uniform. Then disco comes into fashion, so Barbie and Ken need some disco fashions. Since Ken and Barbie are clean living, eventually they will get married, so Ken will need a tuxedo and Barbie will need a wedding dress. (Shacking up would be so much cheaper.) So Ken and Barbie settle down (is there a Ken and Barbie doll house?), have children (more dolls and clothes), save their money and eventually buy a motor home. That's the goodie now being advertised on TV. A Barbie Doll motor home. That's just what is needed to corrupt the youngsters of today in our energy-short (and energy-expensive) society, an eight-mile-per-gallon motor home.

"Look, mommie, look." "Ken and Barbie are waiting in line to get gas for their motor home. It is a very long line. To kill time, they are going in the back. They are closing the door. They are pulling down the window shades." "Will what they are doing help them get gas?"

23 families win turkeys

Twenty-three area families will be enjoying their Thanksgiving dinner turkey through the courtesy of 21 Cass City merchants. The turkeys were given away as part of a free prize drawing sponsored by the Cass City Retail Committee. The Cass City IGA Foodliner decided to give 3 turkeys. They were won by Regina Salcido, Gagetown, and Terry Weir and Nora Frederick, both of Cass City. Other winners in the contest were: Archie Weller, Cass City, from Schneberger's TV, Appliance and Furniture; Murill Shagena, Cass City, from Bigelow Hardware; Judy Hall, Cass City, from Quaker Maid Dairy; Donna Peters, Cass City, from The Paint Store; Bobette Ostrander, from Ben Franklin Store; Linda Mellendorf, Cass City, from Albee's True Value Home Center.

Also enjoying free turkeys are: Barb Burdon, Gagetown, from Clothes Closet; Mary Sherrard, Cass City, from Coach Light Pharmacy; Alice Hoppe, Cass City, from Erla's Super Market; Cheri Martin, Cass City, from Croft-Clara Lumber, Inc.; Doug VanAllen, Cass City, from Federated Store; Marion Welter, Cass City, from Gambles; Maurice Joos, Cass City, from Geiger-Hunt Ford, Inc.; Sean Zawilinski, Cass City, from Kritzman's, Inc. Concluding the list are: Emery Kady, Gagetown, from Old Wood Drug; Tom Heilig, Minden City, from

Zonta Club nets \$196 for donations

Cass City Zonta Club held its monthly dinner meeting at Edith Little's Nov. 16, hosted by Janice Chippi, Beverly Little, Anna McCalum and Mrs. Little. An auction was held which netted \$196, earmarked for the hospital fund. Five guests were present. Individual Christmas gifts will be given to patients at the Provincial Home and the hospital who don't have visitors. Next meeting will be at Helen Baker's, with an exchange of Christmas gifts.

Phone 872-2252

CASS CITY

Thanksgiving thru Sunday
Nov. 22 - 23 - 24 - 25
HOLIDAY DOUBLE FEATURE
Special Schedule Due To Length.
"Voices" 7:30 Only
"Breaking Away" 9:30 Only
Sorry, No Bargain Nite This Week

They were from separate worlds but you'll always remember them together.

"Voices: I Will Always Wait For You"
-- 2nd New Hit --

"AUDIENCES WILL SIMPLY CHERISH 'BREAKING AWAY.'" Richard Schickel, TIME MAGAZINE

BREAKING AWAY

PG PARENTS STRONGLY CAUTIONED
R RESTRICTED
M MATURE AUDIENCES ONLY
TV TV PARENTS STRONGLY CAUTIONED
TV MA TV MATURE AUDIENCES ONLY

RETURNS NEXT THURSDAY
"Animal House"

Want Help Finding What You Want? Try The Want-Ads Today!

Cass City Chronicle

Who says you need \$10,000 to earn big interest?

New: FOUR-YEAR SAVINGS CERTIFICATES...a new way to earn even bigger interest on your savings, with a minimum deposit of only \$500. Mutual's new four-year Savings Certificate rate varies and is based on current U.S. Treasury yields. And you will earn a quarter percent more than all banks pay on these savings instruments. This is the highest rate Mutual has ever offered for less than a \$10,000 deposit. Check with Mutual for the current rate and check your savings in for more interest. There is an interest penalty on early certificate withdrawals.

New: CONTINUOUSLY COMPOUNDED SAVINGS ACCOUNTS...you will earn the best rate in town on a Statement Savings account when you save with Mutual. Our new 5.50% account pays you a big 5.73%. That's a quarter percent more than all banks pay on regular savings accounts. You don't have to be a big saver to earn big interest at Mutual Savings. Mutual Savings pays a quarter percent more than all banks on four-year Savings Certificates and Statement Savings accounts.

More: EMERGENCY CASH - Available at over 4,500 locations. FEE-FREE TRAVELERS CHECKS AND MONEY ORDERS - There's no charge for travelers checks or money orders at Mutual. SATURDAY SAVINGS - All our 24 convenient locations are open 'til noon each Saturday. Isn't it time you got more for your savings dollar?

It is time to give a tax break to savers. America can't afford to wait much longer.

Stop in at any of Mutual's 24 convenient Mid-Michigan locations and get the clear savings picture.

Bay City 3 offices Auburn 1 office Cass City 1 office East Tawas 1 office Essexville 1 office Midland 2 offices Pinconning 1 office Saginaw 2 offices Standish 1 office West Branch 1 office

MUTUAL SAVINGS

A GREAT HOLIDAY GIFT FOR THE WHOLE FAMILY!

CALORIC RLP 359 30" Gas Range

- Automatic Pilotless Ignition
- Tri-Set Burner Controls
- Black Glass Oven Door
- Surface and Oven Lights
- Clock
- Clean-Look Energy System.

Available at \$449.95

VISA, Master Charge or use our convenient payment plan
Hours 8 a.m. to 5 p.m. (Monday thru Friday)

Southeastern Michigan Gas Company

Sandusky 648-2333

Check your telephone directory for a toll free number for your area.

Grain elevators date from 1880s

Link with past set for demolition

By spring, Cass City's last link with its agricultural past may be gone.

The grain elevators on Vulcan Street, built in 1884 and 1888, and other buildings are scheduled to be torn down, possibly starting this winter.

Wickes Agriculture was still using some of the facilities there until it completed its move to Main Street in September, when its new office-warehouse building, fertilizer storage building and scales were completed.

The parent company, according to local manager Bob Wischmeyer, is trying to find a contractor to tear down all the old structures on Vulcan Street, after which the property will be sold. He is hopeful work will get started this winter.

The first elevator on the site was built in 1884 by Anson G. Berney, two years

after the Pontiac, Oxford and Northern Railroad was built from Pontiac to Cassville through Cass City.

It was Cass City's first modern (for then) elevator. There was at least one grain business in operation before then, owned by John Heflebower and Frank Miller.

In 1888, brothers Frank and Leo Miller built an identical elevator directly to the north. Berney bought them out two years later and operated both plants until Feb. 4, 1899.

That's when Amual Frutchet bought them. He then formed a partnership with Alanzo Ale and Elmer A. McGeorge under the name of Frutchet-Ale-McGeorge.

The year before, Frutchet had purchased the elevator in Gageton from Reginald Kline, in exchange for the farm he (Frutchet) owned

1 1/2 miles north of Cass City.

ACCORDING TO ART ATWELL, who went to work at the Cass City elevators in 1906, the three partners soon built six bins with a capacity of 6,000 bushels, primarily to store excess grain during harvest time.

Came harvest time in 1899 and the new bins were filled with oats. When they had an opportunity to ship the 6,000 bushels, Frutchet and McGeorge, who worked in the plant, insisted that their partner sell them.

Ale, who kept the books and did the selling, refused. "The price went down and they lost their shirts," Atwell wrote several years ago. "Soon after this, they bought Ale's interest in the plant."

That was in 1900 and the name was changed to Frutchet-McGeorge and Co. In 1902, it was incorporated

as Cass City Grain Co. with Frutchet as president and McGeorge, vice-president.

ATWELL, 89, WHO LIVES at 4404 Oak Street with his wife of 60 years, Lena, recalls Frutchet as being a tight man with a penny. In one instance, when his employees tore down an old building, Frutchet had them pull out all the nails and straighten them. That's when nails were selling for \$2 a pound.

He also recalls Frutchet often saying, "Take a profit and you won't go broke."

Atwell began work at the grain company in 1906 in charge of plant operations and became manager in 1921. He retired from that position in 1956, but remained as assistant treasurer and board member until the then Frutchet Bean Co. sold its Cass City facility to Wickes Agriculture in

1968.

In 1901 or '02, Frutchet and McGeorge bought or leased the Brown City elevator. Frutchet's son, Joe, then became the manager.

Joe later moved to Cass City and was secretary of the Cass City Grain Co. His brother, Herb, was treasurer.

IN 1907, THE COMPANY

bought William McCallum's small elevator on Main Street by the railroad tracks, which McGeorge operated under his own name.

In 1910, a group of farmers bought the Main Street facility, incorporated under the name Farm Produce Co., and then built a modern elevator to the south of the old one.

McGeorge sold his interest in the Cass City Grain Co. and bought an elevator in Gladwin. He later sold that, moved to Oregon, later moved back to Michigan and died in 1923 at age 61.

His old partner, Amual Frutchet, died in Florida in 1931 at age 82.

The Cass City Grain Co. continued its purchase of other elevators and moved its headquarters to Saginaw in 1922. It merged with the Michigan Bean Co. in 1923. The two companies dissolved in 1933 and reorganized under the name of Frutchet Bean Co. with Joe Frutchet as president. By 1965, it was operating 24 elevators in Michigan.

In 1960, Frutchet Bean bought the Farm Produce Co. on Main Street. Ground was broken for the concrete silo, with a capacity of 175,000 bushels, in December, 1963. It was completed in time for the fall, 1964, harvest season. The old elevator at that site was destroyed in a massive fire Sept. 29, 1965.

Two more concrete silos, with total capacity of 250,000 bushels, were added in 1975.

DECKER

The DBC & W Railway was built in 1913 from Bay City to Sandusky.

The elevator was built in 1914. Atwell doesn't know the year it burned. It was not rebuilt because of the threat the railroad would be dismantled.

An auction was held finally in Bay City, with the intention of selling the railroad for junk.

"Joe Frutchet and I attended," Atwell wrote. "There were several junk dealers... (there)... together with a man from Chicago, Mr. Mills. He made the first bid of \$200,000. This was the one and only bid.

"Mr. Mills operated the railway for quite some time and later dismantled the line from Sandusky to Decker and from Bay City to Caro. Mr. Mills operated what was left... until his equipment became obsolete, then it was dismantled entirely."

KINGSTON

Atwell recalls, but isn't sure, that brothers Ted and Lon (or Loam) Snelling bought the elevator, but doesn't know from whom. It was apparently built in the late 1890s or early 1900s.

The Snelling brothers also owned and operated the hotel in Kingston.

Many old elevators long since gone



WAITING FOR DEMOLITION -- The two elevators are still standing, with demolition tentatively scheduled to start some time this winter. Photo was taken this summer, when Wickes Agriculture was still using the site for some purposes.

Art Atwell was in the grain elevator business for 62 years.

He worked all of that time for the Frutchet Bean Co. or its predecessors in Cass City.

He is knowledgeable, not only about the history of the Cass City elevators but also about other ones that existed in this area, almost all of which are gone. Much of that history he wrote down several years ago.

DEFORD

Some time after the Cass City Grain Co. was established in 1902, the company bought a site at Deford for an elevator, lumber yard and bank.

A framed barn was moved next to the railroad and converted into an elevator. Next to it, a two-story building was moved or built. The upper story was used for women to sort beans, which were bagged and stored on the lower level.

The elevator was destroyed by fire May 3, 1916. It was rebuilt and burned a second time July 5, 1924. It was again rebuilt.

The bank was organized under the name A. Frutchet and Sons. It was one of the few banks that survived the

bank holiday of the 1930s as 100 percent solvent. The bank was robbed Sept. 9, 1935 of \$636.

The then private bank was closed when it became mandatory that it would have to become a state bank to stay in business. Frutchet Bean then used the building as a clearing house.

The elevator was sold to Ralph and Betty Terry in July, 1961. It closed in the mid-1960s.

NEW GREENLEAF

In 1913, the Grand Trunk Railway built a spur, the D & H Railway, from Cass City to Bad Axe, 18 miles long, which went through New Greenleaf.

The elevator was built the following year, as was a general store, by Angus McLeod.

The last run on the spur was in April, 1951, after which the track was dismantled. The elevator then had to haul all its beans and grain out by truck. The elevator is still in business, now owned by Thumb Area Commodity Cooperative, Inc.

Farmers built an elevator northeast of Greenleaf at Atwater Road along the D & H tracks. It burned April 30, 1933, and was not rebuilt.

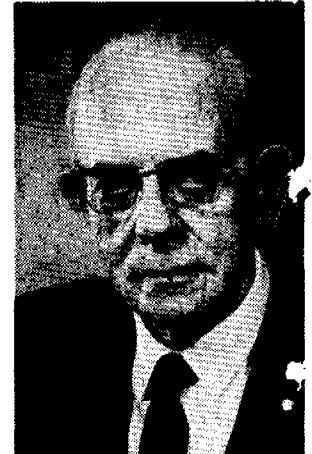

ART ATWELL (1970 photo)

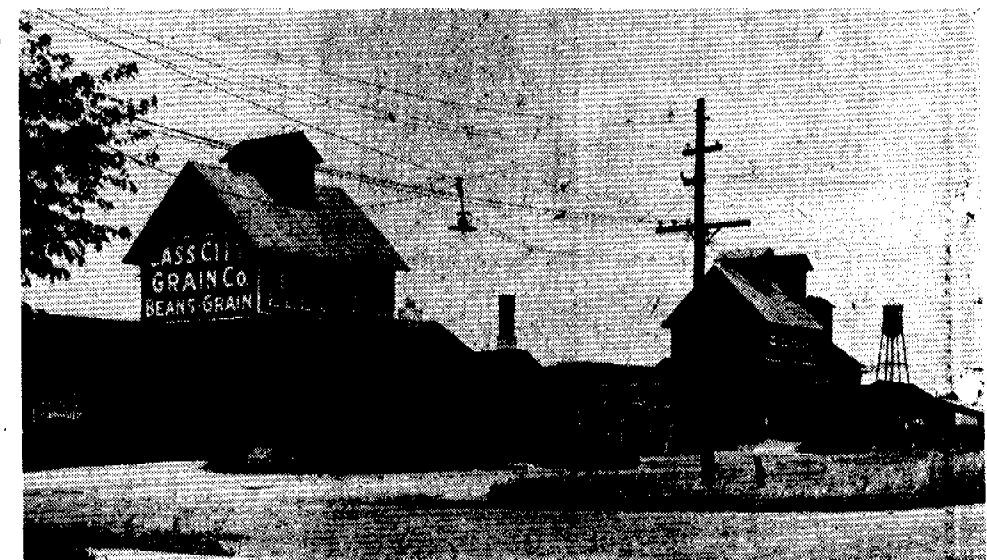

GLORY DAYS -- This was the Cass City Grain Co. in its better days. The elevator on the left was built in 1884; the one on the right in 1888. They came under single ownership in 1890.

Clubhouse burns

Investigators from the State Police fire marshal's office were continuing their investigation Tuesday into the cause of a fire that destroyed the Arrowhead Golf and Country Club clubhouse near Caro early Monday.

An unofficial estimate of the loss is close to \$100,000. The wood-frame clubhouse contained a restaurant, pro shop and two bars.

The fire was reported at 12:42 a.m. Monday by a motorist who spotted it while driving by on Gun Club Road.

Caro firemen were at the scene from then until 6 a.m. Elkland township firemen assisted by bringing a tanker to the scene. Mayville firemen brought a pumper and a tanker.

Caro Fire Chief Don Berry said Monday afternoon he had no idea what might have started the blaze. It was his understanding that the owner of the golf course, Art Dore, did have insurance on the structure.

Dore was later quoted as saying he had no plans yet for rebuilding the clubhouse.

It was the second fire at the golf course this year. The earlier fire destroyed a storage building and equipment inside. Cause of that one was never determined, Berry said.



Cutlass Salon Brougham

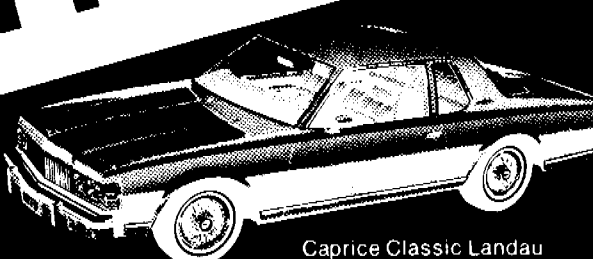

Caprice Classic Landau

Fantastic Cash Rebate

'43'

1979 Chevrolets and Olds In Stock

Demos, Cars & Trucks All At

CLOSE OUT PRICES!

MAKE YOUR BEST DEAL AND RECEIVE

2 - 1979 Camaro	\$200.00 CASH REBATE
3 - 1979 Monte Carlo	\$200.00 CASH REBATE
5 - 1979 Chevettes & Wagons	\$200.00 CASH REBATE
10 - 1979 Impala & Caprice	\$300.00 CASH REBATE
5 - 1979 Olds 98 Regency	\$400.00 CASH REBATE
7 - 1979 Cutlass Cpe & Wagon	\$200.00 CASH REBATE
4 - 1979 Pickup's	\$300.00 CASH REBATE
7 - 1979 Blazer, Vans & Suburban	\$400.00 CASH REBATE

SALE ENDS DECEMBER 15

Buy Early And Make Your Best Choice Of The Inventory.

Must Be A V-8 Engine To Receive Rebate.

Take Cash Or Apply It To Your Down Payment



OUVRVY

CHEVROLET-OLDS, INC.

Keep That Great GM Feeling
With Genuine GM Parts

Phone 872-4301

Cass City

PINE CONE SHOP

6240 W. Main, Cass City Phone 872-2155

- Cone Baskets
- Wreaths
- Dried Flower Arrangements

Our own fresh cut Christmas Trees after Dec. 3. Also greens.

Order Your
GRAVE BLANKETS NOW

SOMETHING NEW!

**BARN ROOM WITH OLD STUFF
AND COLLECTIBLES**

HOURS: Monday-Thursday 9-5
Friday 9-7 - Saturday 9-2



BEST FOODS FOR LESS!

Tender Aged Beef

RIB STEAKS **1.89** Lb.

Erla's Home Cured Hickory Smoked

PICNICS

79¢ Lb.

Erla's Homemade Bulk

PORK SAUSAGE

\$1.09 Lb.

Erla's Homemade Fresh

LIVER RINGS . 89¢ Lb.

Fresh Picnic Style

PORK ROAST . 69¢ Lb.

Erla's Mild Sensation

Ring Bologna

Large Bologna

Skinless Franks

1.19 Lb.

Russette Frozen Ranch Style

HASH BROWNS AND Regular FRENCH FRIES

Hickory Smoked Rindless Sliced

LAYER BACON

\$1.09 Lb.

Fresh - Whole or Rib Half

PORK LOINS **\$1.09** Lb. Sliced Free

Erla's Homemade

GERMAN STYLE Summer Sausage.. **\$1.59** Lb.

Erla's Homemade

Braunschweiger.. **98¢** Lb.

Dinty Moore

BEEF STEW 40 oz. can **\$1.79**

Schmidts Medium or Extra wide

NOODLES 10 oz. pkg. **44¢**

Nestles with Mini Marshmallows

HOT COCOA MIX 24 oz. Pkg. **\$1.99**

Barg & Foster

MILK CHOCOLATE CHIPS 12 oz. Pkg. **\$1.29**

Golden Griddle

SYRUP 36 oz. btl. **\$1.49**

Kraft Casino

MOZZARELLA LB. PKG. **\$1.79**

Sunsweet

PRUNE JUICE 40 oz. btl. **89¢**

67¢ 2 lb. bag

Aunt Jane's Polish or Kosher

DILL PICKLES 16 oz. **88¢**

Kraft Pimento or Regular

VELVEETA 2 Lb. Pkg. **\$2.59**

Campbell's

Cream of Mushroom SOUP

10 oz. cans **4/\$1.00**

POWDERED SUGAR 2 lb. Poly Bag **77¢**

Kelloggs

RICE KRISPIES 13 oz. pkg. **97¢**

Cinnamon Graham

GRAHAM CRACKERS lb. pkg. **69¢**

Bakery Specials

Oven Fresh

Rye Bread 1 Lb. Loaf **68¢**

Oven Fresh Whole or Cracked Wheat

Bread 1 Lb. Loaf **68¢**

Oven Fresh

Brown'n Serve Twin Rolls **2/89¢**

Oven Glo

White Bread 1 1/4 Lb. Loaf **3/\$1.19**

Weaver Yellow

POPCORN 'Big' 8 lb. bag **\$1.79**

Brooks Hot

CHILI BEANS 15 oz. can **38¢**

4 Kinds

DANDEE PRESERVES 2 lb. jar **99¢**

Cole's Frozen

Garlic Bread 16 oz. pkg. **79¢**

McDonalds Low Fat

Milk Gal. **\$1.39**

Motts Natural Style

Apple Sauce 20 oz. jar **59¢**

'Love My Carpet'

Deodorant 12 oz. size **\$1.19**

Merico Frozen

English Muffins 10 ct. pkg. **49¢**

Barrel Head

Root Beer • **7 Up**

Sunkist

Orange POP 8 1/2 Liter Btl. **\$1.49** Plus dep.

Roman Pink

DETERGENT 32 oz. btl. **49¢**

Specials Good Fri., Nov. 23 thru Wed., Nov. 28

TIDE

Laundry

DETERGENT

171 oz. pkg. **\$4.99**

(Special Label)

Franco American

SPAGHETTI 4 14 oz. cans **\$1.00**

Companion

DOG FOOD 25 lb. Bag **\$3.99**

McDonald's

Ice Cream 1/2 Gal. **\$1.39**

• Butterscotch • Fudge Sundae • Chocolate Marshmallow

Erla's Food Center

IN CASS CITY

OPEN MONDAY THURSDAY TO 6 P.M.
FRIDAY TO 9 P.M.
SATURDAY 8:00 A.M. TO 6 P.M.

BEER WINE

MEMBER T.W. FOOD STORE

Size 24 California

Pascal Celery Bunch **59¢**

New Crop Florida

Grapefruit 4 For **99¢**

U.S. No. 1 Mich.

Potatoes 10# Bag **69¢**

Cello

Carrots 5 1/2 pkgs. **\$1.00**

Banquet Assorted Frozen

POT PIES 4 8 oz. Pkg. **\$1.00**

Heinz

KEG-O KETCHUP 32 oz. Btl. **88¢**

— Health & Beauty Aids —

Breacol \$1.54 Cough Medicine 3 oz. Reg. \$1.99

Scented or Unscented

Clairol \$1.84 Final Net Reg. \$2.29

Listermint 24 oz. Reg. \$2.39 **\$1.99**

Deer hunters do well, Jarvis says

Deer hunters "seem to be doing quite well," according to Carlton (Bud) Jarvis, Department of Natural Resources wildlife biologist for Tuscola county.

Deer brought to the Caro DNR office by hunters wanting a "successful deer hunter" patch, he said, were "certainly in nice shape," with good racks, often 7 or 8 points, and "fat."

Thirty-nine hunters showed up opening day, compared to 30 on the first day of firearms deer season last year, and by the end of the day Saturday, there had been a total of 90. That compares with about 85 for the first three days of deer season last year (which started on a Wednesday).

Through the end of the season, Nov. 30, the office will be open regular hours, from 8 a.m.-5 p.m. weekdays. It is located on M-24, south of Caro.



SUCCESSFUL HUNTERS -- Harold Hunt and son Dan of DeLong Road, Deford, both shot bucks opening day. Dad's was a whopper, 14 points (15 if the one broken off is counted) and weighing 200 pounds, shot at 5 p.m. Dan got his 7-pointer, weighing 125, at 7:30 a.m. Both were shot in approximately the same area, south of Cass City.

After funds cut

80% retain CETA workers

Most persons who were "out of a job" when federal Comprehensive Employment and Training Act (CETA) funds used to pay them expired Sept. 30 did not go on unemployment rolls.

According to Thumb Area Consortium Executive Director Frank Lenard, about 80 percent were retained by the local governmental units that had been paying them with CETA funds, but are now paying them out of their own budgets. The consortium administers the federal program in the upper Thumb.

New federal regulations that went into effect last year specified that all persons paid with CETA funds prior to Oct. 1, 1978 could only stay in the program one more year. Those hired after that could only be paid with the federal funds a maximum of 18 months.

The new regulations meant governmental units with CETA personnel prior to Oct. 1 of last year had to decide whether to put them on their regular payrolls as of Oct. 1 this year or let them go.

The Tuscola County Board of Commissioners, for instance, decided to keep all the county's CETA help (18 employees). The Cass City Village Council let one worker go. (Two were retained.)

Reports submitted at last Thursday's consortium administrative board meeting presented an overall picture of what happened in the three upper Thumb counties.

There were 272 persons enrolled in the CETA Title II-D public service employment program during the period April 1-Sept. 30.

Of those, 70 were retained by their employing governmental unit, to be paid with regular funds, and 15 found other jobs.

One was transferred to another CETA program and eight had other "positive terminations," such as going on to school or joining the military.

That left 76 terminated for "non-positive reasons" (dismissed because of the end of CETA funding, fired for poor performance or quitting -- a breakdown of how many for each reason isn't available) and 102 eligible to continue in the program after Oct. 1.

There were 646 persons enrolled in the CETA Title VI public service employment program during all or part of the six-month period that ended Sept. 30.

Of those, 33 were put on the regular government payroll by their employing unit and 54 found other jobs. Thirty were transferred to other CETA programs and 18 went to school, joined the military, etc.

There were 219 non-positive terminations (end of CETA funding, fired or quitting). There were 292 who continued in the Title VI program after Sept. 30.

Also at the consortium meeting, the board set new travel rates, effective Dec. 1, which are the same as the ones set for state employees (which went into effect Oct. 1).

Mileage paid to consortium employees, all of whom use their own cars, will be 18½ cents per mile, up from 17 cents.

Maximum reimbursements, paid only on business outside of Huron, Sanilac and Tuscola counties, are for breakfast, \$3 (up from \$2.50); lunch, \$3.75 (up from \$3.50); dinner \$8 (up from \$7.25), and lodging, \$27.75 a night (up from \$19.50).



LEO TRACY of Elmwood Road, Cass City, shot this 13-pointer at 7:30 a.m. opening day four miles east and 1½ miles south of Cass City. He also got a buck last year.

Novice bags buck with muzzle loader



DANIEL BOONE would be proud of Ron Jones, 14, who used the muzzle-loading rifle he is holding to down this buck the first day he had ever gone deer hunting.

Not too many teenagers get a buck in their first year of hunting.

Ron Jones, 14, not only did that last Thursday, he shot the animal with a muzzle-loading rifle.

Ron is the son of Mr. and Mrs. Robert Jones of 1332 Main Street, Snover, and the grandson of Harvey Bartle of Cass City.

According to his mother, Ron's father and brother, Bob Jr., 21, are both long-time muzzleloader enthusiasts, so it was only natural that when Ron became old enough to go deer hunting, he would do it with one of the antique-type one-shot weapons. (Ron's is a modern-built replica, which he got this year.) Before going hunting, of course, he did practice with the weapon.

The three of them went hunting opening day about five miles northeast of Snover. According to Mrs. Jones, Ron was the first to spot the buck, fired from about 30 yards away and downed the animal. The four-pointer weighed more than 100 pounds, but she wasn't sure how much more.

For the unknowing, muzzleloaders only get one shot before they have to laboriously reload, so if the first shot misses, chances are slim the animal will stick around long enough for a second shot.

Ron shot the deer about 8:30 a.m., after about 1½ hours out in the field.

"He was really excited about it," Mrs. Jones said of her son, an eighth grader at Sandusky Middle School.

As of Saturday morning, neither Bob nor Bob Jr. had got a buck. The father has been successful in the past, but his older son has yet to down a deer.

The irony, according to Mrs. Jones, is that prior to opening day, Bob Jr. was kiddingly advising his younger brother that "no buck is going to walk up to you."

None did, but one got close enough.

Rapid Washer
Hoover Rapid Washer
THE AFFORDABLE PORTABLE
Miser on Electricity, Water, Detergent
Wash 1-Load, Spin-Dry Another At Same Time
SAVE \$25.00 Per Unit
Register Today, For A Free 7-Day CARIBBEAN CRUISE
ALBEE Home Center Cass City

BIGELOW HARDWARE
Cass City

20% OFF

On Selected Merchandise

CHRISTMAS SAVING SALE

- Hand Tools
- Power Tools
- Housewares
- Stanley
- Thorsen
- Skill
- Rockwell

HURRY! Sale Nov. 22 - Dec. 10 Only
Phone 872-2245

AUCTION SALE

The following personal property will be sold at public auction located 3 miles west of Cass City on M-81, 1 mile south on Dodge Road on:

Saturday, Nov. 24
at 12:30

- Machinery & Miscellaneous:**
Wagon with Gravity Box
Wagon with Flat Rack & Grain Box
9 ft. Cultipacker
2 Row, 3 Point Cultivator
2 Section Harrows
6 ft. Double Disc
16 ft. Aluminum Grain Elevator
Gas Tank & Stand
Water Tank
Rubber Tire Wheel Barrow
Electric Fencer
Extension ladders
Drill Press
Bench Vise.
Chicken Crates
Electric Fence Posts
Axes
Forks
Shovels
- Feed:**
Approx. 300 Bales of Hay
Approx. 100 Bales of Straw
- Household:**
Whirlpool Refrigerator with Top Freezer
Gas Cook Stove
Kenmore Electric Dryer
Dining Room Table with Leaves
Set of 4 Chairs
Day Bed
Buffet
Davenport

- Desk
- 2 Double Beds - complete
- Dresser
- Swivel Rocker
- Chest of Drawers with Mirror
- Large Rug - like new
- Hoover Sweeper
- Wash Tubs
- Metal Cupboard
- Kitchen Table
- Dishes
- Pots
- Pans
- Picnic Table
- Other Items

- Antiques:**
#3 Dinner Bell
Copper Clad Kitchen Range - good
Maytag Washer
Wood Cupboard
3 Rocking Chairs
Several Odd Chairs
Pictures & Frames
Small Table
2 Dressers with Mirrors
Trunk
Feather Tick
3 Copper Boilers
Milk Cans
Hand Corn Sheller
Paddle Wheel Grinder
Platform Scales
Buck Saw
Others



SANTA'S HOUSE -- Painting a door that isn't a door at Santa's house was Julie Vargo, a 10th grader. She and fellow high school art students, Kathleen Vargo (her sister) and Caroline Swart, did the art work. Home economics students made and installed the curtains. Santa makes his debut at the ex-gas station at Seeger and Main at 2 p.m. Friday.

THE CASS CITY CHAMBER OF COMMERCE

Is Proud to Announce

Christmas Home Decoration Contest

GRAND PRIZE \$100

Plus 3 Additional Prizes

- \$50 - MOST ORIGINAL - HUMOROUS
- \$50 - NATIVITY or CHRISTIAN THEME
- \$50 - LIGHTING

Contest Rules

- Judging will be held December 18, 19 and 20 from 6-9 p.m.
- Winners will be announced December 21 at Community Christmas Carolling.
- All prizes will be awarded.

Entrance Form -- \$250 in Prizes

Name _____
Address _____
City _____
Send Entry To: Suzanne Chappel
6860 Herron Drive
Cass City, Michigan 48726

Ben Ritter, owner

CLERK: Hillaker Auction Service
TERMS: Cash. Everything settled for day of sale. Not responsible for accidents.
AUCTIONEER: Lorn Hillaker, Phone 517-872-3019 Cass City

Osentoski learns about kids by doing

This fall, Michigan State University student Carl Osentoski of Ubyly is learning about child care through direct contact with the gingles, pent-up energy and lingo of the younger set. Either through volunteer-

ing, required classwork or student teaching, he and several other MSU students are gaining valuable experience working with children at any of the four on-campus child care centers operated by the MSU Institute for Family and Child Study. "These students are integral parts of the program," said Jean Grof, operations coordinator for the centers. "Their duties range from aiding the head teachers as volunteers to supervising the classroom as student teachers."

Their charges range from 2 weeks old to preschool age. Just under 200 youngsters are cared for daily at the drop-in facility, day care center and two nursery schools that are provided for the offspring of MSU students and the East Lansing community. The facilities offer learning programs as well as play activities, Grof said. Such programs include learning logical thought processes, numbers, colors, seasons of the year, the alphabet and how to read.

Osentoski, a sophomore majoring in social work, is a volunteer at the Children's Corner, the Clinical Center's drop-in child care facility for young patients awaiting a routine physical exam or for offspring of grown patients. Osentoski and the other volunteers attempt to make the children feel as comfortable as possible under the circumstances of a doctor's visit.

"The Children's Corner serves as a learning experience to help me gain an understanding of interpersonal relationships and the socialization process," he said.

The 1974 graduate of Ubyly High School is the son of Mr. and Mrs. Ray Osentoski of Bay City-Forestville Road.



CHRISTMAS SPIRIT -- Village workmen started putting up the downtown decorations Friday, including a new tree (artificial) at each corner of the Main-Seeger intersection. In front is Tom Crickon. Behind the tree is Russ Bradley.

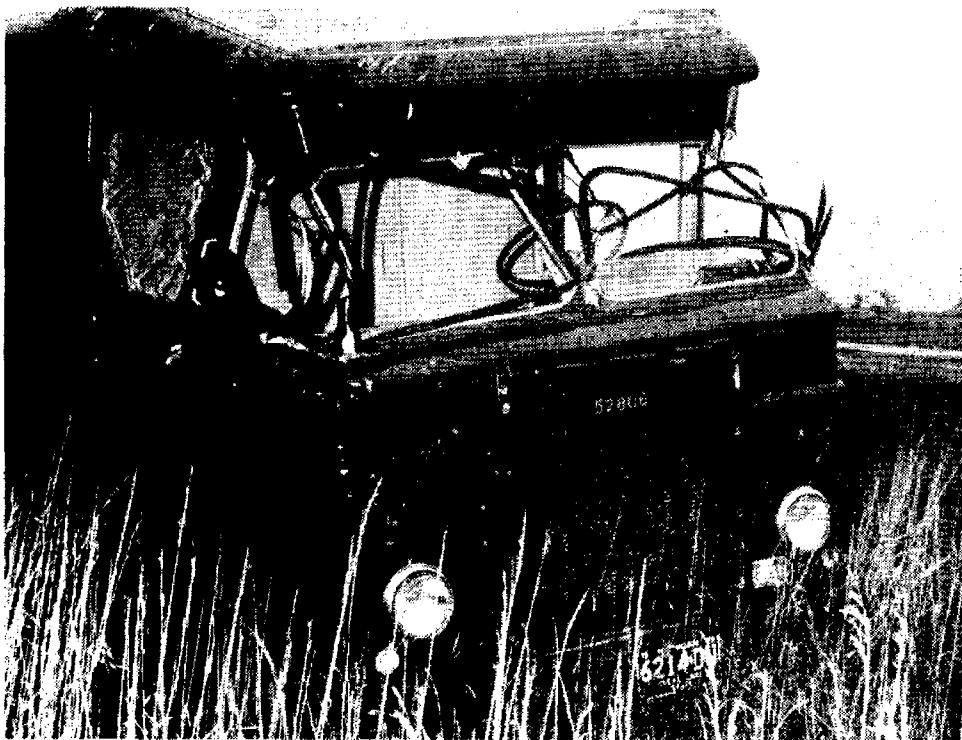

MINOR INJURIES -- United Parcel Service driver Al Wallace escaped with minor injuries after his truck rolled over one complete revolution after being involved in a collision last Thursday. The other driver, William J. Hartman, was ticketed by deputies in connection with the crash.

Rollover results in only minor injuries

A Cass City United Parcel Service driver escaped with only minor injuries when his truck was involved in a collision last Thursday and rolled over.

Treated and released from Hills and Dales General Hospital was Alfred Wallace, 33, of 6605 Third Street. The sheriff's department reported he was headed northeast on M-81 when he collided with a car that had pulled into the intersection, headed east on Akron Road. The accident took place at 3:30 p.m.

The driver of the car, William J. Hartman, 19, of Akron, was ticketed by officers on a charge of failure to yield right of way. He told officers he had let two cars go by but hadn't spotted the approaching UPS truck when he started to pull into the intersection.

After the impact, Wallace's truck spun around, rolled over in a ditch on the north side of M-81 and came to a halt upright in a field.

The Hartman auto, which suffered minor damage, came to a halt on Akron Road, east of the intersection.

OTHER ACCIDENTS

David H. Bartnik, 21, of 6524 Van Dyke Road, sought his own treatment after a mishap in Cass City at 2:30 p.m. Sunday.

Village police reported that Bartnik was westbound on Main Street on his motorcycle and ran into the rear of a car halted in the left lane at the stoplight at Seeger.

The cycle glanced off the car and struck another one halted in the right lane for the light.

Driver of the first car hit was Evelyn Sue Langenburg, 18, of 6197 Koepfgen Road; the second, Clarence L. McQuarrie, 66, of Marlette.

Gordon Walsh, 15, of Ubyly, was treated and released from Huron Memorial Hospital, Bad Axe, for injuries suffered Saturday when his motorcycle flipped over when he lost control while trying to avoid a deer.

He told Huron county deputies he was southbound on Verona Road, six miles south of Atwater Road in Austin township, Sanilac county, when the deer crossed the road.

Four accidents took place in northeastern Tuscola county last Thursday.

Caro state police reported that at 7:40 a.m., Mary H. Phillips, 28, of Phillips Road, Deford, was southbound on Kingston Road, south of Rossman Road, when her car started to slide on the icy roadway. It slid 100 yards and then rolled into a ditch on the east side.

At 9:15 a.m., according to Tuscola deputies, Pamela Kay Stone, 23, of E. Elmwood Road, Caro, was westbound on M-81, west of Lamton Road, when her car slid off the north side of the road, went down an embankment, spun around and hit a dirt mound.

She told officers she lost control on the icy surface when she approached a slower moving vehicle.

At 2:10 p.m., deputies reported, Scott A. McLeod, 20, of 3920 Little Road, Cass City, was westbound on Little, east of Duprey, when he lost control on the wet and bumpy gravel road. The car rolled over on its roof on the north side of the road.

At 11:40 p.m., Scott D. Miller, 19, of Hughes Road, Owendale, was southbound on McEldowney Road, deputies said, when he lost control when turning right onto Bay City-Forestville Road.

The car went off the south side of the road and came to a halt upside down.

Cass City police reported that at 2:55 p.m. last Wednesday, Daniel J. Lewicki, 20, of 6040 Walnut Street, Kingston, was turning right into a parking place in the Walbro lot on Garfield Street, when he collided with a car that was attempting to pass him on the right. Driver of the other vehicle was David S. Erla, 23, of 6730 Third Street.

CAR-DEER

At 10:20 p.m. Friday, Clayette Lane, 17, of 6594 Pine Street, was eastbound on M-81, east of Crane Road, when her car struck a deer, deputies reported.

Caro state police said that at 6 p.m. Saturday, Beverly Keck, 38, of Gregory, was northbound on Kingston Road, south of Deckerville Road, when her auto collided with a deer.

The car of Connie Nicol, 39, of Deckerville Road, Deford, collided with a deer at 6 p.m. Sunday while she was northbound on Cemetery Road, north of Shabbona Road, according to deputies.

Robinson stands mute to theft related charges

Kenneth G. Robinson, the last of three persons to be arraigned in Tuscola county in connection with a multi-county theft ring operation, stood mute to two charges in circuit court Nov. 13.

Robinson, 32, of 6332 First Street, Mayville, faces two charges of receiving and concealing stolen property over \$100.

He is charged with purchase of a stolen lawn tractor from William Payea Aug. 22 in Mayville and a stolen motorcycle from Payea Sept. 5 in Vassar township.

(Payea is charged in Crawford county with breaking and entering an unoccupied dwelling in connection with the theft ring.)

Circuit Judge Norman A. Baguley entered pleas of innocent for Robinson and scheduled hearing of motions Dec. 10, to be followed by a pretrial hearing. Bond was continued.

Also Nov. 13, Craig A. Reinert, 21, formerly of Millington, was sentenced to 60 days in the county jail for violation of probation. He was credited with 44 days served. Probation was revoked.

He pleaded guilty Oct. 22 to the violation, of having failed to report to his probation officer in August.

He was placed on two years' probation in April, 1978, for attempted larceny in a building.

The guilty plea of Arturo Saldana, 21, of 1797 Van Geisen Road, Caro, to breaking and entering an unoccupied dwelling was taken under advisement. Sentencing, if the plea is accepted, will be Dec. 10. Bond of \$50,000 was continued.

His guilty plea was in a plea bargain with the prosecution, he having pleaded guilty to breaking into a

house in Caro Jan. 30 of this year, in exchange for dismissal of a charge of attempted safe damage in connection with another break-in the same day in Caro.

Preliminary examination for Larry E. Winter, 29, of Sebawaing, will be heard in district court, Baguley ruled. Bond was increased to \$1,500, cash or surety.

He is charged with driving under the influence of liquor (third offense), having been arrested on the charge Sept. 8 in Indianfields township.

The prosecution has filed supplemental information alleging that if convicted on the drunk driving charge, he will be a third felony offender for purposes of sentencing under the Habitual Criminal Act. That allows the judge to increase the sentence beyond the normal maximum for the original charge.

Nov. 14 before Judge Baguley, Robert E. McComb, 20, of Davison, pleaded guilty to armed robbery at what was scheduled to be the start of a jury trial on the charge.

His plea was accepted and sentencing scheduled Dec. 24. Bond was continued.

The robbery was that of Leo Waterman Feb. 15 near Fostoria. About \$100 and a cigarette lighter were taken.

Martin D. Peters of Flint earlier pleaded guilty to the same charge in connection with the robbery and was sentenced by Baguley to 2-3 years in the State Prison of Southern Michigan at Jackson.

**For Fast Results
Try
Chronicle
WANT ADS**

SAVE \$125

ALL CAST IRON BEN FRANKLIN STOVE

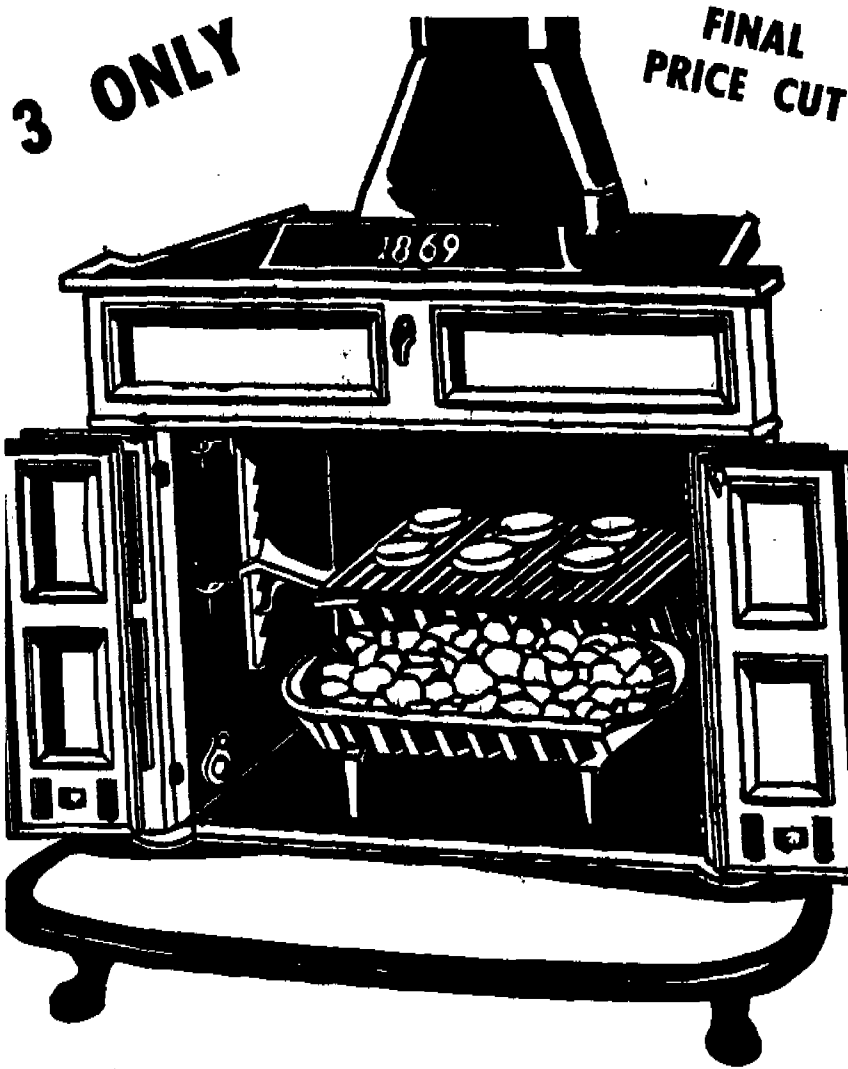

Grate, Reducer and Screen Included

Reg. \$299.95 **\$179⁹⁵**

SPECIAL PRICE GOOD ONLY FOR 3 STOVES NOW IN STOCK!

CROFT-CLARA

LUMBER, INC.



Phone 872-2141

Cass City

We Have Something Exciting For You

\$100⁰⁰

And Here Is All You Have To Do

During November
Buy A 1979 or 1980
Car or Truck
at

Geiger-Hunt

B & W Auto

Rabideau Motors

Owry Chevrolet
Olds

Finance It With

The Pinney State Bank

We'll Send You A Check For Up To \$100.00
See Us For Details

The Pinney State Bank

FDIC

Cass City, Michigan 48726
(517) 872-4355



Bach Festival kicks off Friday with lecture by Dr. Rosella Duerksen

Formal festival activities begin at 7 p.m. Friday with a lecture by Rosella Duerksen, holder of a doctorate in sacred music and director of music at the First Presbyterian church in Iowa City, Iowa.

The program continues with a recital featuring Tom Brown, organist at the Church of St. John the Evangelist in New York City, at the tracker organ, and Doris Ornstein, instructor at the Cleveland Institute of Music, at the harpsichord. (Ticketholders are urged to be there at 7, rather than wait for the recital.)

SATURDAY

At 2 Saturday is the free lecture by Dr. Duerksen and at 3, showing of a harpsichord film by Ms. Ornstein. The concert is at 8, followed by a reception which will give the public a chance

to meet the musicians. Leading off the program will be Doris Preucil of Iowa City, Iowa, nationally known teacher of the Suzuki Violin Method and concertmaster of the Iowa Bach Festival, and her son, William Preucil Jr., playing a violin concerto. A student at Indiana University, this summer he won the 24th annual Young Artist competition for piano and orchestral instruments in Minneapolis.

William Preucil Sr. will be playing viola in the festival orchestra. Next on the program will be a tenor solo by Waldie Anderson, voice instructor at the Interlochen Fine Arts Academy. Mezzo soprano Rosemary Russell will sing next. She is an associate professor of voice at the University of Michigan. Ms. Ornstein will perform next on the harpsichord, followed by baritone Jay

Thompson, also on the staff at Interlochen. The final number will feature the 23-piece orchestra, with Tom Brown on the organ.

SUNDAY

Late Sunday morning will be a brunch for the musicians and their host families, prepared by the local Order of the Eastern Star chapter. The concert begins at 3, starting with a concerto for oboe and violin, performed by husband and wife Norman and Catherine Paulu. Paulu, the violinist, is first violinist of the international-

ly known Pro-Arte Quartet in residence at the University of Wisconsin in Madison. His wife has performed with numerous orchestras as an oboist. Their daughter, Laura, will be playing flute in the festival orchestra.

The concert -- and festival -- will conclude with the singing of the Magnificat in D by the Ann Arbor Cantata Singers, conducted by Bradley Bloom.

Formed in 1960, the group performs regularly in Ann Arbor, makes guest appearances elsewhere and will soon release its first recording.



PLAYING TOGETHER -- One of two families that will be performing in the Village Bach Festival will be William Preucil (top), his wife, Doris, and son William Jr., from Iowa City, Iowa. Preucil will play viola in the orchestra; his wife and son are Saturday night soloists.



BAROQUE SAMPLER was the title of the lecture-concert given by Mrs. White last Wednesday evening. Following her lecture and solo performances on the harpsichord, she accompanied the choral ensemble, directed by Jim Hobbs.



LOOKING BACH -- Examining part of the Bach display at Rawson Memorial Library are some of the members of the Village Bach Festival committee. From left, Holly Althaver, co-chairman; Jeanne Auten, hospitality; Alice Lovejoy, chairman for the library exhibit; Bill Lovejoy, treasurer, and Rev. Harry Capps, co-chairman.

Talent galore at Festival

will be performing at the Sunday afternoon concert. Ms. Ornstein, a member of the faculty at the Cleveland Institute of Music, is nationally known as a soloist and ensemble musician. She not only is bringing the film, she is also bringing her harpsi-

chord, which is the size of a small piano. At Rawson Memorial Library this week, open during regular library hours, will be a display of art and photographs depicting Bach's time and books about the German composer, who lived from 1685-1750, and the Baroque period. He composed much of his music for churches. The display will also tentatively be open from noon-3 Sunday.

HELP

Mrs. Althaver estimates more than 100 Cass Cityans have or will be involved with putting on the festival in some way, in what she describes as "indeed a community wide affair."

Members of the planning committee, in addition to her, Rev. Capps, Mrs. Ouvry and Jaeger, are Jeanne Auten and Nancy deBeaubien, reception committee (housing, meals, etc.); Alice Lovejoy, art exhibit chairman; Bill Lovejoy, treasurer; Lambert Althaver, printing and mailing; Jan Hagey, publicity; Kathleen O'Donnell, coordinator of artist-in-residence program, and George Cole, scheduling.

The committee formed to put on the event has as a nucleus members of the Presbyterian church, Cass City Arts Council and the school Community Education Program.



AT THE BATON will be Don Th. Jaeger, conductor and festival artistic director, from Midland. (The "Th." stands for Theodore.)



ARTIST-IN-RESIDENCE at Cass City High School this past week in connection with the Village Bach Festival was Ellen McIntosh White, who worked with the general chorus and choral ensemble. Tuesday of this week, she was to have given concerts for elementary and intermediate school youngsters.

Fuel costs still going up, up, up

Continued from page one

homes in the county with electric heat.

Based on last winter's usage, the average Detroit

Edison customer with electric heat used 2,288 kilowatt hours from November through May and 766 from June through October of this year.

Based on present rates and that amount of electricity, the homeowner will pay \$903 for electricity for the 12 months, of which \$422 will be for non-heating purposes, the rest for heat. That's an increase of about 4 percent. Edison has a rate increase pending, Anderson said, but approval if it comes isn't expected at least until spring.

FIREWOOD

"It's great. I never dreamed I'd be so busy," said Joe Viney of the firewood business so far.

He got into the business a couple of months ago, when he was laid off as a supervisor at Sebawa Industries. He's back at work now, so is cutting wood in his spare time.

He figures he has sold more than 200 face cords so far, mainly to people in the immediate vicinity. Most customers who are burning wood for the first time, he said, previously were using fuel oil, which they keep as a secondary heating source. Viney may benefit from a prominent location, on Cemetery Road south of Cass City. Two other wood sellers contacted by the Chronicle, Ken and Terri Graichen of Cemetery and Mushroom Roads, and Rev. John and Jean Lange of

Lamton Road, reported few buyers.

On the other hand, Viney's location may be too prominent. Someone stole his \$500 wood splitter a couple of weeks ago.

Firewood prices range from \$18-20 picked up (for cheaper types of wood or green wood) to \$35 delivered. None of those contacted were selling firewood a year ago, but based on prices quoted in a Chronicle article last year, firewood appears to be up about \$5 a cord over last year. (Viney checked before setting his prices and thought they were close to the going rate a year ago.) According to Deford wood heater dealer Dan Allen, a heater capable of keeping a house warm can burn from 7-8 to 30 face cords a winter, the number depending on the efficiency of the unit.

Correction

The order of names in last week's Chronicle was incorrect.

In the photo labeled "Two Daniels," the proper order from left was Jane Dickinson, Lisa Britt and Jason McCallum.

The two Owen-Gage cheerleaders were Kris Erickson on the left and Mary Kay Burrows, not the opposite as stated.

The surest way to stay poor is to try to get rich quick.

GIFT GIVING IDEAS



You'll find something for everyone on your list at your local independent hardware store with national chain-buying power.

 <p>Libbey 24-pc. set PERFECT STACKERS 8.88 Incl. 8 each: 12-oz. beverage, 16 1/4-oz. cooler, 9-oz. rock glasses. 82479</p>	 <p>MECHANIC 35-DRAWER CABINET 10.95 Enameled-steel cabinet. See-thru drawers. 16 1/2 x 12 x 5 3/4 in. MMC35</p>	 <p>Sunbeam ELECTRIC SHAVER 8.44 Micro-twin head—one side for legs, the other side for underarms. 76-231</p>	 <p>WEAR-EVER CHICKEN BUCKET 27.99 Low-pressure speed fryer for crispy chicken. 6-qt. cap. Aluminum. 90026</p>	 <p>Sunbeam SELF-CLEANING STEAM IRON 19.99 Shot of steam feature removes wrinkles. 36 vents. Switchable cord. 11-174</p>
 <p>THE EGGORY OMELET PAN 24.99 Cooks an omelet in 4 mins. or grills burgers or sandwiches on 5-in. sq. Teflon-coated pans. MO370</p>	 <p>SEAL-A-MEAL BAG SEALER 9.99 Seal leftovers, meals, seasonal foods in airtight, boilable bags. SAMI Bags: 7001/2/3 2.19</p>	 <p>WEST BEND 10-CUP DRIP COFFEEMAKER 21.99 Brews 10 cups in about 8 minutes. 2 cups in about 2 minutes. Warming plate keeps serving temp. 5975</p>	 <p>PRESTO FRYDADDY DEEP FRYER 19.99 Deep-fries 4 servings in just 4 cups oil. Snap-on lid stores oil. Non-stick, easy-clean coating. 05420</p>	 <p>PLANT LIGHT KIT 7.99 Highlight and help plants grow. Incl. 75W bulb with adjustable holder, 6-ft. cord, on/off switch. PLK1</p>

ALBEE True Value HOME CENTER

Cass City



Phone 872-2270

Cass City IGA Foodliner

Food Stamps Gladly Accepted

Beer, Wine & Holiday Champagne
We now have Bag Ice

STORE HOURS: Daily to 6:00, Tuesday & Friday to 9:00
CLOSED THANKSGIVING ALL DAY

Fast Photo Finishing Service
for Your Shopping Convenience

Ad Good Thru Sat., Nov. 24, 1979.

NOTE: Not responsible for errors made in printing. QUANTITY RIGHTS RESERVED.

IGA WHAT'S SO SPECIAL AT IGA? Thanksgiving Thank You Sale!

savings value quality
★ Our Best Recipes

SilverStone
This Week's Feature

IGA Coupon
EKCO ETERNA® COVERED
3 Qt. Saucepan
\$8.99
Each
SAVE **\$1.00**
3 Qt. Saucepan
Coupon expires Nov. 24, 1979. NR

IGA BONUS COUPON ① IGA BONUS COUPON ②

FAME Famous for Quality
100 PAPER PLATES
9 INCH SIZE
SAVE **40¢**

FAME White 9 in. Paper Plates
69¢
Limit 1 100 ct. Pkg.
Limit one Coupon per family. With this Coupon and \$16.00 purchase, excluding Beer, Wine, Cigarettes or other Coupon items. Coupon expires Nov. 24, 1979. NR

20% OFF LABEL
Palmolive
Dish Liquid
89¢
Limit 1 32 oz. Btl.
Limit one Coupon per family. With this Coupon and \$16.00 purchase, excluding Beer, Wine, Cigarettes or other Coupon items. Coupon expires Nov. 24, 1979. NR

PLAY **TOUCHDOWN** Odds
WIN UP TO **DOLLARS**
\$1,000

PRIZE VALUE	NO. OF PRIZES	ODDS FOR ONE TICKET	ODDS FOR TWO TICKETS
\$1,000.00	3	134,667 to 1	67,334 to 1
\$ 100.00	25	16,160 to 1	8,080 to 1
\$ 10.00	75	5,387 to 1	2,694 to 1
\$ 5.00	150	2,693 to 1	1,347 to 1
\$ 1.00	3,787	107 to 1	54 to 1
TOTAL	4040	100 to 1	50 to 1

DETAILS, INCLUDING RULES, ARE AT PARTICIPATING STORES.

INSPECTED BY U.S. DEPARTMENT OF AGRICULTURE

We Have Available
Swift Premium
Ducks, Geese,
Capon &
Roasting Chickens

TABLEKING • SELF BASTING
Young Tom Turkeys
58¢ lb.
18 lbs. & Up

Tableking Sliced Bacon
88¢
1 lb. Pkg.

integrity savings value quality

U.S. NO. 1 Dole Bananas
4 / \$1 lbs

FAME YOUNG Tom Turkeys
65¢ lb.
16 lbs. & Up

PRINCELLA Cut Yams
88¢
40 oz. Can

IGA TABLET BEEF Round Steak
\$1.89 lb.

FAME Tomato Juice
59¢
46 oz. Can

THORNAPPLE VALLEY Boneless Hams
\$1.89 lb.

IGA TABLET BEEF Boneless Rump Roast
\$2.09 lb.

IGA TABLET BEEF Boneless Sirloin Tip Steak
\$2.29 lb.

WEST VIRGINIA Semi-Boneless Ham
\$1.69 lb.

IGA TABLET BOSTON BUTY Pork Steak
99¢ lb.

CALIFORNIA Pascal Celery
49¢ stalk

We Have Available
Mum Plants & Fruit Baskets

CALIFORNIA Red Grapes
69¢ lb.

DEL MONTE Fruits
2/99¢
18 oz. Cans

MICHIGAN Red Delicious Apples
89¢
3 lb. Bag

FAME Cranberry Sauce
39¢
16 oz. Can

CHEF PIERRE FROZEN 9 in. Pumpkin Pie
\$1.39
40 oz. Pkg.

FROZEN Harris 8 in. Mince Pie
\$1.39
26 oz. Pkg.

RAINBOW • ORANGE • LIME Sherbet
\$1.19
1/2 Gal. Ctn.

FROZEN FAME Vegetables
69¢
20 oz. Bag

integrity savings value quality

CAMPBELL Tomato Soup
5/\$1
10 1/2 oz. Cans

integrity savings value quality

OVEN-FRESH Sandwich Bread
69¢
1 1/2 lb. Loaf

QUARTERS Parkay Margarine
2/99¢
1 lb. Pkg.

SINGLES KRAFT AMERICAN PASTURIZED PROCESS CHEESE FOOD
\$1.19
18 ct. 12 oz. Pkg.

FAME Grade A Large Eggs
68¢
Doz. Ctn.

Totino's 10 in. Party Pizza
98¢
11 1/2 - 12 1/2 oz.

OVEN-FRESH Brown & Serv's Twins
79¢
12 ct. Pkg.

NABISCO Snack Crackers
79¢
8-10 oz. Pkg.

SAVE 30¢
Pepto Bismol
\$1.29
8 oz. Btl.

SAVE \$1.49
SX-70 Polaroid Film
\$5.49

SAVE 80¢
Sylvania Flash Bar
\$1.99

30¢ OFF LABEL • SAVE 30¢
Aim Fluoride Toothpaste
\$1.09
8.2 oz. Tube

IGA Coupon
CHEER Detergent
\$1.49
Limit 1 49 oz. Box
SAVE **40¢**

IGA Coupon
KELLOGG Rice Krispies
79¢
Limit 1 13 oz. Box
SAVE **20¢**

IGA Coupon
MAXWELL HOUSE • ALL GRINDS Master Blend Coffee
\$4.89
Limit 1 26 oz. Can
SAVE **30¢**

IGA Coupon
MARIO STUFFED THROWN Olives
89¢
Limit 1 7 oz. Jar
SAVE **50¢**

IGA Coupon
MRS. BUTTERWORTH Syrup
\$1.49
Limit 1 36 oz. Btl.
SAVE **40¢**

IGA Coupon
VETS Nuggets
\$3.99
Limit 1 25 lb. Bag
SAVE **90¢**

Limit one Coupon per family. With this Coupon and \$7.00 purchase, excluding Beer, Wine, Cigarettes or other Coupon items. Coupon expires Nov. 24, 1979. NR

Coach of year

Bulldogs' Arnie Besonen honored

Owen-Gage football coach Arnie E. Besonen has been selected as a Class D, Region III, Coach of the Year by the 32 schools of Region

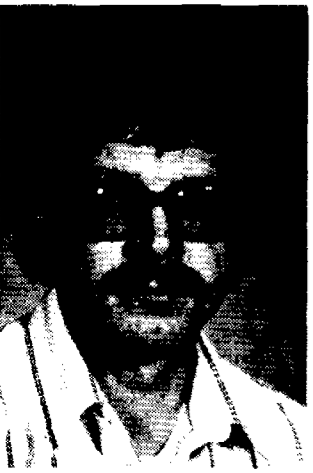

Arnie Besonen

O-G rolls by Warriors in league tilt

It was mother's night at Owen-Gage Nov. 13 and the Bulldogs put on a good show for their mothers, downing North Huron, 48-31, to bring their league mark to 12-1.

Becky Howard led the victors with 21 points. Carol Goslin contributed 10.

Tops for the Warriors was Mary Goretzki with seven. The Bulldogs won the junior varsity matchup, 17-15.

O-G to host D tourney

Owen-Gage plays host for the District 112 Girls' basketball tourney, which starts Monday in the Owendale gym.

In the first round, at 7:30 p.m., the Bulldogs play Akron-Fairgrove. At 7 p.m. Thursday, Nov. 29, Port Hope plays Caseville, both teams having drawn first round byes. At 8:30, the winner of the Monday night contest plays North Huron.

The two winners Thursday night play each other Saturday for the district crown and a berth in the regionals. Game time is 7:30.

Be careful when buying by mail

While holiday preparations are usually typified by frantic shoppers and crowded shops and malls, the Better Business Bureau of Metropolitan Detroit reminds persons that thousands of purchases are also made by mail.

The great majority of mail order companies are legitimate and honest, although some are not. Many problems that do arise are a result of people forgetting to include their names and-or addresses on their orders.

Some complain too soon. Generally, one should allow 4-6 weeks for delivery before making a complaint. When you receive merchandise in the mail that you have not ordered, you may consider it as a gift. Nothing can be mailed to you without your consent unless clearly marked as a free sample or as merchandise from charitable organizations asking for a donation. Either way, the merchandise is a gift. You are not obligated to return or pay for the merchandise.

In order to assist perspective mail order shoppers, the Better Business Bureau also offers these suggestions: -Carefully read catalogues and always keep a copy of the ad or brochure. -Pay by check or money order and never in cash, and include any shipping or handling charges.

III. Besonen guided his team to a 9-0 regular season, which earned them a playoff berth by winning Class D Region III with 64 points. The season ended Nov. 10 with a 34-20 loss to Michigan Lutheran Seminary in the first round of the playoffs. The Bulldogs finished the 1979 season as North Central D League champs with a 6-0 record, rated No. 5 in the AP and UPI polls, No. 6 in the Detroit News poll, and No. 8 by Hal Schram of the Detroit Free Press.

Besonen, assisted by Phil Gray, Dean Roller and John Osterland, has in his 10 years at Owen-Gage amassed a 75-17-2 record.

A native of Trout Creek, he is a graduate of Northern Michigan University and Central Michigan University, and is a resident of Port Austin. He and his wife Nadene have a 7-year-old son, Graham, and are expecting their second child the end of November.

Besonen, when not coaching football or boys' and girls' track, is active in community affairs. He is a member of the Port Austin Village Council, Port Austin Lions Club, emergency medical technician with Thumb Ambulance, Little League coach at North Huron and Region 11 director and scholarship chairman of the Michigan High School Football Coaches Association.

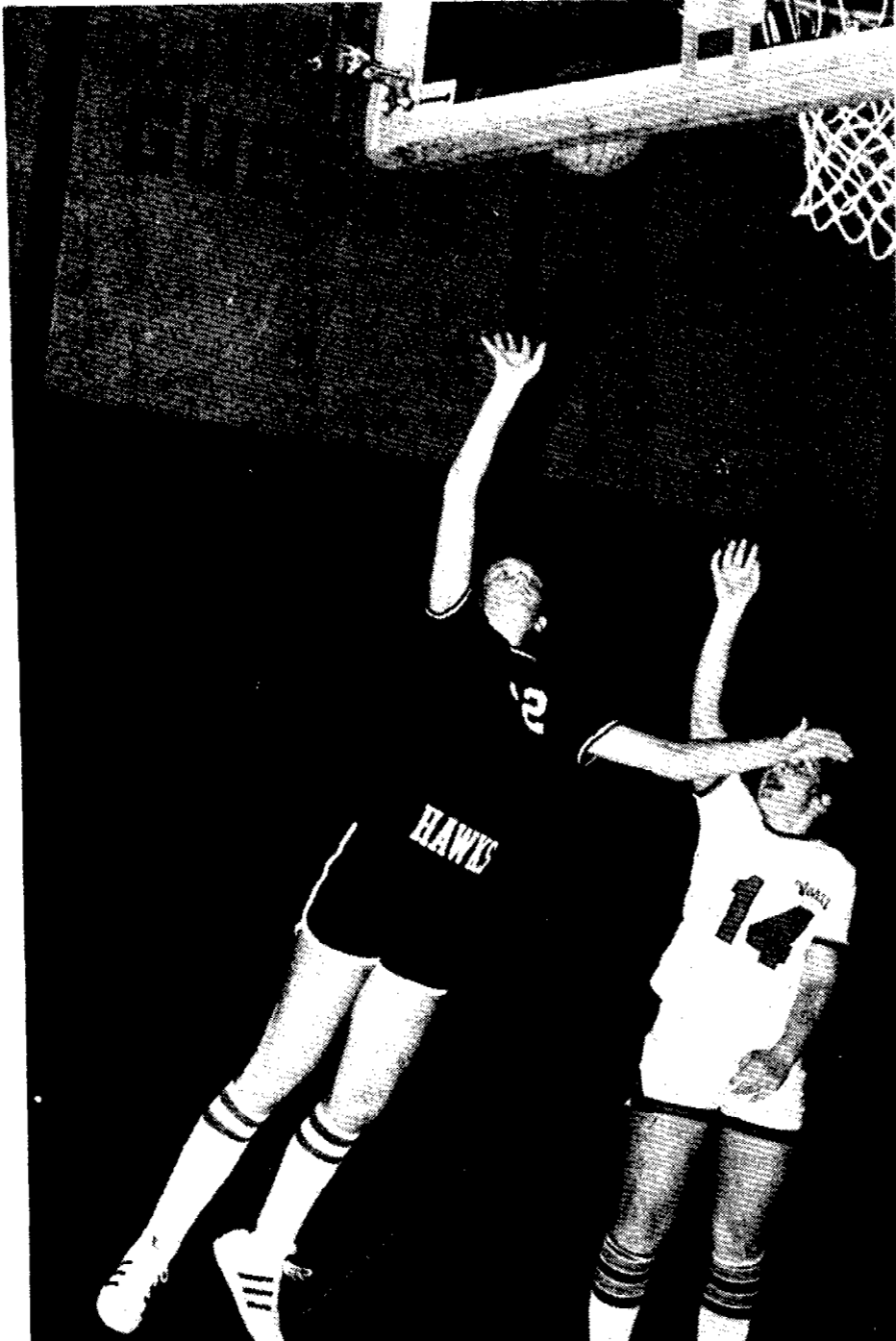

PADGETT RANDALL goes up for two points on a fast break as the Cass City Red Hawks overwhelmed the Vassar Vulcans in a key game in the drive for the Thumb B Conference title. Defending is Sue Rodammer.

2 wins cap Hawks' drive to 1st title

The Cass City Red Hawks won the first Thumb B League championship in the school's history Tuesday night against a surprisingly strong Laker quintet, 55-45. Although the Hawks led all the way the game was still up for grabs through the first three quarters. Contrary to the Vassar game when they blew up the Vulcans with a first period blitz Cass City kept chopping away at the Lakers to win the championship.

At the end of the first quarter it was 16-14. By intermission Cass City had edged ahead 30-24 and at the end of three quarters added another three points to the lead to be comfortably ahead 43-32. After that it was mop up time.

Padgett Randall, Cass City's and the Thumb's leading scorer, led all scorers with 18 points. Libby Hartel added 10, and 15 rebounds. For the Lakers, Robin Smith, 16, and Gail Fritz and Cindy Krohn, 10 each, were in double figures.

With one non-league game left the Hawks are 13-1 in league play and 15-3 overall. This is the eighth year of girls' basketball at Cass City and Coach Lloyd Schinnerer's charges are the first to add a league trophy to the school's trophy case although Cass City dominated Class C play for several years behind stars like Lisa

Zimba and Elaine Stoutenburg.

VASSAR GAME

When the Cass City Red Hawks met the Vassar Vulcans Oct. 22 the two teams went into overtime before the Hawks squeaked out a victory.

So with the Thumb B Conference title at stake last Wednesday for the Hawks, observers were looking for a tight, hard-fought game.

What it turned out to be was no contest. The Hawks jumped off to a 13-2 lead in the first six minutes and coasted to the victory, 51-26.

The Vulcans were unable to penetrate the Hawks' zone defense and shots from the outside failed to drop. Meanwhile, Cass City, led

by Libby Hartel, was rebounding well and getting close-in shots.

In the second quarter Coach Lloyd Schinnerer was able to rest his starters and give his bench game experience. At the half the Hawks led, 22-10.

The Hawks added points to the margin in the third period and then the game into a rout. The 17-8 final quarter edge was

Hartel led all scorers with 16 points, the only Hawk in double figures. Bobbie Feller led Vassar with 10 points. Vickie Pobanz snared rebounds, closely followed by Hartel and Padgett Randall with 11 each.

The Hawks are to face tough USA Wednesday night in a tune-up in the final game of the regular season.

Tough C district pits 4 top Thumb teams

Unquestionably the toughest class C district basketball tournament in the Thumb and possibly northern Michigan this fall will be played at Laker High School next Monday through Saturday.

There are four, Bad Axe, USA, Cass City and Harbor Beach, exceptionally strong teams competing for the title.

The Hawks are Thumb B Conference champions with a 15-3 record. Bad Axe, 16-3 with a 13-game winning

streak is the only team to defeat Cass City this year in the Thumb B. Harbor Beach, 13-5, uses the height of 5-11 Sue Mausolf and team quickness to power past opponents.

Perhaps the class of the tourney is USA which has one defeat this season, recorded in the opening game. Since then they have come on like gangbusters behind six-foot Sue Engelhardt. By the luck of the draw none of the four tourney

favorites will meet in the first round.

Cass City and USA drew byes. Harbor Beach faces Ubyly Nov. 26. Bad Axe meets the Lakers Nov. 27.

USA plays the winner of the Ubyly-Harbor Beach game Wednesday, Nov. 28, while Cass City takes the floor against the Bad Axe-Lakers winner Thursday, Nov. 29.

The second round winners meet for the district championship Saturday, Dec. 1. All games are at 7:30 p.m.

SPECIALIZATION

The person who succeeds is the one who knows everything about something, not something about everything.

Bowling

THURSDAY NITE TRIO

- Nov. 15, 1979
Van Dale 4
Del Nicholas Trucking 4
Jacques Seeds 4
IGA 3
Garno Seeds 3
Cargill Seeds 3
Wildwood 1
Draves Dist. 1
Big John's 1
Oops 0
Caro True Value 0
Hillside Barber Shop 0

- High Series: G. Deering 611.
High Game: A. McLachlan 221.
200 Games: A. McLachlan 221, D. Sowden 212, G. Deering 212-207, B. Babich 210, R. Root 203, C.R. Smith 202.
Men's 550 or Better: G. Deering 611, A. McLachlan 598, R. Root 570, D. Sowden 554.

WOOD'S is VALUE PACKED

THE BEST BUYS ARE RIGHT AT HOME IN CASS CITY THIS YEAR THE STORE IS OLD WOOD DRUG!

American Greeting Boxed Cards

Final Week Of Early Bird Special

20% OFF

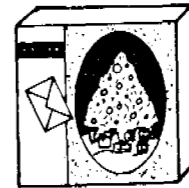

VISIT OUR \$2 AND UNDER DEPT.

for 100's of great gift ideas.

Our buyers have been picking up great ideas all year just for you!

Gifts from Wood's are appreciated more!

- Emerson 2-Speed Portable Phonograph 29.95 Value \$18.99
8 Track Stereo w/2 speakers 59.95 Value \$39.99
All Albums - Even Christmas - Discount Priced

- Pkg. of 20 Instant Stick Christmas Bows \$1.00 Value 59c
STICK-ON BOWS

- 25 Sheet Fiat Fold White Tissue 69c Value 49c
Scotch 66c value Transparent Tape 44c
Fold Up Gift Boxes Pkg. of 2, 3 or 4 88c
\$4.95 Value Tinsel Garland \$2.49

- 8 Pack Pepsi All Types Coke - 7-up - Faygo's 1/2 Liter Bottles \$1.49 + Deposit \$2.29 Value

- Low Fat Milk Super Special \$1.49 Gal. Reg. discount price \$1.65
Half Pint Reg. 78c WHIPPING CREAM 59c

Choose Early! Sanders and Fanny Farmer Fine Chocolates Fresh - Delicious - Tasty
OLD WOOD DRUG The Corner Store with a Whole Lot More
FREE FLORIDA TRIP TICKETS OPEN SUNDAYS 12-4

Watch For Our Discount Christmas Sale Catalog In The Mail!

Brides' delight... our beautiful Flower Wedding Line Invitations THE CASS CITY CHRONICLE Phone 872-2010

HUNTING ACCIDENTS ... can cost you your business ... your home ... your income ... your life savings! If you accidentally injure someone on your hunting trip. For a policy to give you complete "in the field" protection make sure you call... HARRIS-HAMPSHIRE AGENCY, INC. 6815 E. Cass City Road Cass City Phone 872-2688

Deer season underway

Lots of buck luck for area hunters

Like son, like mother. Larry Stevens of Severance Road, Cass City, bagged a 4-point buck about 7:30 p.m. opening day in the woods behind the family's home, east of Cemetery Road. It was his first buck in several years of hunting. He went to get a truck and while driving it into the woods to pick up the animal, scared another buck towards his mother, Joyce, whom he had been hunting with. She fired and the 4-pointer was hers, also

her first in several years of hunting.

Keith Bye of Shabbona Road, Decker, shot a 12-point buck weighing 180-200 pounds Friday in the Deford area. It was his third buck in his years of hunting.

Drew Guernsey of 4593 N. Seeger Street shot a 150-pound, 7-point buck at 10 a.m. opening day in the Deford State Game Area. It was his first buck in seven years of hunting.

Ben McAlpine of S. Elkton Road, Gageton, downed a 6-point, 180-pound buck on his farm at 10 a.m. opening day.

Don Miller of Cemetery Road shot a 7-point buck at 8:45 a.m. opening day west of Cass City.

Jerry Hillaker of Snover shot his first-ever buck at 6:45 a.m. the opening day. The 6-pointer was downed two miles west and one mile south of Argyle.

Rick Lashley, 18, of Lansing, hunting with John Graham of rural Caro, shot a 7-pointer at 8:15 a.m. opening day. It was his first in three years of hunting.

Bernard Shagena downed his third deer in three years at 9 a.m. opening day east of Cass City. The 3-pointer weighed an estimated 150 pounds. Shagena is from Sebewaing.

Greg Hutchinson, 15, in his

second year of hunting shot his first buck opening day, a 9-pointer that weighed about 150 pounds dressed. It was downed one mile east and 1 1/2 miles north of Cass City. He is the son of Mr. and Mrs. Alvin Hutchinson of Seventh Street.

Dailey Parrish of Dodge Road, Cass City, bagged an 8-point buck weighing 170 pounds Friday afternoon west of Cass City. He shot a buck in the same area last year.

John T. Graham of rural Caro shot a 13-point buck while hunting on his farm Friday afternoon.

Roger Nicholas of Kawkawlin, a former Uby-Cass City area resident, shot an 8-point, 150-pound buck Saturday in the Daus Road area, northeast of Cass City.

Scott Stine, 16, of Cedar Run Road, bagged a 6-point, 140-pound buck, his first, while hunting Friday in the Daus Road area northeast of

Cass City. Paul Bliss of 6337 Houghton Street downed an 8-point buck at 2 p.m. opening day west of Cass City.

Harold Craig of 4814 N. Seeger Street shot a buck Friday while hunting in the Big Rapids area.

Tom Lefler, 14, of Cass City, bagged a 4-point buck Friday at 8:30 a.m., weighing 185 pounds, while hunting east of Cass City.

Ask about
MONTHLY MONEY FROM MUTUAL
MUTUAL SAVINGS

Cass City Retail Committee Presents

OLD-FASHIONED

Christmas Sale

Free Drawing
Free Movies

AND GIANT HOLIDAY SEASON SPECTACULAR

Most Cass City Stores Open Nights Circled In Calendar

December 1979

SUN	MON	TUE	WED	THU	FRI	SAT
						1
2	3	4	5	6	7	8
9	10	11	12	13	14	15
16	17	18	19	20	21	22
23	24	25	26	27	28	29
30	31					



JOIN THE FUN

FREE FLORIDA TRIP FOR 2

NOTHING TO BUY — NO OBLIGATION. JUST COME IN AND REGISTER. REGISTER AT ANY PARTICIPATING STORE. REGISTER OFTEN FOR A BETTER CHANCE TO WIN. NEED NOT BE PRESENT TO WIN.

PLUS 2 \$50 "LUCKY BUCK" DRAWINGS

Dec. 8 and 15

FREE DRAWING TICKETS AVAILABLE AT ALL PARTICIPATING CASS CITY STORES. MUST BE PRESENT TO WIN "LUCKY BUCK" DRAWING

3 Free Movies

Children 12 and Under

Saturday-2 p.m.

- Dec. 1 - "Wacky World of Mother Goose"
- Dec. 8 - "Digby - The Biggest Dog In The World"
- Dec. 15 - "Race For Your Life Charlie Brown"



Santa Arrives FRIDAY

2 P.M.

At His House In The Former Boron Station Corner Seeger and Main
FREE CANDY FOR KIDDIES

Santa Claus Hours

- November 23..... 2 till 4
- November 24..... 12 till 2
- November 25..... 1:30 till 3:30

MOST CASS CITY STORES

OPEN SUNDAY

Noon to 5 p.m.

November 25

Dec. 2 - 9 - 16 - 23

ASK FOR YOUR

FREE SUNDAY

COFFEE TICKETS

AT PARTICIPATING STORES

Singles club plans dance

The YMCA Thumb Singles Club of Sandusky will conduct a dance Saturday at Sandusky High School from 8:30 p.m.-12:30 a.m.

Music will be provided by Denny Ewald and the Music Makers. It will be a Thanksgiving party, with a potluck meal served at 10. Bring a dish of food to pass. Table service will be provided. It will also be guest night, with married couples invited. Anyone who is over 25, single, widowed or divorced is invited to attend any time and join the club.

Oftentimes small talk can cause enormous problems.

Kingston schools release first period honor roll

Following is the Kingston High School and Junior High School honor roll for the first nine weeks of the 1979-80 school year.

Keith Flis, Bradley Widger, B or better: Lana Chantiny, Christopher Clinesmith, Brenda Clouse, Gary Cooper, Michelle Easton, Paul Galbenski, Lisa Kelly, Michelle Lanway, Dawn Legg, Alice Miracle, Deanna Newton, Annette O'Dell,

Wendy Rogers, Larry Smith, Lori Smith.

EIGHTH GRADE

All A's: Cathleen Szostak. B or better: Jill Benedict, Michael Byers, Faith Campbell, Shelly Crosby, Belinda Eldridge, Lynne Gilmore, Mathew Kopko, Denise James, Kelly Jaster, Lori Langley, Lynda Lis, Christopher Martin, Julie Mosher, Douglas Randlett, Jill Reehl, Keith Richter, Christine Rosinski, Timothy Ruggles, Eric Stoll.

NINTH GRADE

All A's: Karyn Schneider. B or better: Debra Cummings, Julie Galubenski, Faye Gilmore, Tim Klimek, Jennifer Lalko, Irene Lowe, Della Marquardt, Darren Mathews, Derek Morell, Tina Smith, Rodrick Ware, Mike Weitschat, Lori Wroubel.

TENTH GRADE

B or better: Diane Catlin, Chris Creason, Mark Davis, Douglas Flis, Mike Harper, Martha King, Sandy Johnson, Kenton Kelly, Jim Legg, Drenda Marquardt, Shirley Miller, Renee Newton, Gerilyn Priess, Dawn Reehl, Beth Ruggles, Vicki Smith, Marvin Wolak.

ELEVENTH GRADE

All A's: Greg Barrons, Ken Trisch, Beth Ann Childs, Lisa Mathews. B or better: Audrey Ahern, Mark Brandibur, Robert Hackel, Janet Heron, Jason Koehler, Ron Lewicki, Joan Magiera, Bill Miracle, Lori Parker, Becky Pierce, Sherry Prusinski, Rodney Rushlow, Jaime Silvernail, Ronda Smith, Sue Socha, Blaine Phillips, Sherri Bastian, Julie Parker, Kim Ruggles.

TWELFTH GRADE

All A's: Karen Banowski, Beth Britton, Kathy Dereszynski, Sally Engler, Lori King, Marie Lalko, Lisa Lyons, Pam McLemore, Tina Neu. B or better: Lynne Chantiny, Angie Dandron, Sue Dibble, April Finlayson, Kelli Gilmore, Chris Lockhart, Roy McAlpine, Carmen Miracle, Scott Nemeth, Gary Peter, Arlene Pierce, Lori Stewart, Darlene Trisch.

Meredith Auten remembers



When I was 16, we had three horses: Maude, which was then 20 years old and the most faithful animal which ever lived; Giotto, Maude's colt, a marvelous roader, which I had broken to shake hands and to nod his head when I asked if he wanted some oats, and Lady, a beautiful sorrel mare which Father proudly drove to a sulky every morning and curried and brushed until she was almost mouse color. I delivered milk around town in a hard rubber tired buggy.

One dark night on my delivery route, I ran over a big, high pile of dirt on Main Street. The buggy tipped over with me on the ground. Maude, the beautiful animal that she was, proceeded home on the run and went straight for the barn. That was okay, only the buggy caught the side of the door and was a pitiful sight when I got there. Father was pretty perturbed.

A few days later, I took Giotto down to the freight train to get a tent, which we had sent down from Caseville.

Giotto had a head too large for the bride and so I fastened the throat latch over the top of his head. The conveyance that Giotto was harnessed to was a one-horse wagon. I drove up to the side of the freight car and went in to get the tent. While I was in there, Giotto shook the bride off. I came out with the tent and away went Giotto at full speed.

When he went across the tracks, the box flew off, the reach which connects the back wheels to the front broke and Giotto went down the tracks pulling only the front wheels end-over-end. Shortly, the last of the harness came off and Giotto was completely free.

He ran south on the tracks towards the river. I expected to see him go across the railroad bridge and break a leg or two, but when he came to the bridge, he suddenly stopped and came running back to me. The wagon was a pitiful sight. Father was furious.

A short time after that, I had Lady harnessed to our new pneumatic-tired buggy. It started to rain. I drove up to the front porch and got out to get an umbrella. Lady

took one glance at the brelia which I had put and away she went, down the south drive and around. She came in north drive at full speed as she passed the barn, there was a hitching post, which rear wheel of the carriage caught.

The carriage was a pitiful sight. Father was delirious. I wasn't worth sending college, so quietly, I pulled my money out of the bank and bought my first pair of trousers, and weighing 10 pounds, proceeded to Bowdoin College, where I went into more trouble than a freshman on campus.

But that's another story. Later I loved the college. Everything comes out right in the end.

School Menu

NOV. 26-30	MONDAY	Ham & Cheese on Bun Chips White Milk Apple Sauce Cookie
	TUESDAY	Macaroni & Cheese Buttered Peas Bread-Butter White Milk Fruit Jell-o
	WEDNESDAY	Hot Dog & Bun Chips Buttered Beans White Milk Apple Crisp
	THURSDAY	Mashed Potatoes Hamburg Gravy Bread-Butter Peach Slices White Milk Cookie
	FRIDAY	Barbecue on Bun Chips Buttered Corn White Milk Cookie

Menu subject to change.

Girl Scouts make excursions

The Cass City Girl Scouts enjoyed a skating party at the Blue Blazer in Caro Nov. 7 after school.

Seventeen Brownie Scouts of Troop 865 and their leaders, Karen Smith, Joyce Loomis, Judy Profit and Hilda Koch and driver, Sharon Francis toured television station WNEM, Channel 5, near Saginaw Nov. 6 after school. Following the tour, the group stopped at Hill orchards, west of Caro, and

enjoyed cider and doughnuts.

Junior Girl Scout Troop 170 and leaders Arlene Szarapski and Theresa Suggden visited Provincial House in early October and put up Halloween decorations for the residents to enjoy.

Brownie Troop 827 and leaders Carol Rutkoski and Marty Nickolson made Thanksgiving decorations for Provincial House and the girls put them up.

DIAMONDS
See ...
Wm. Manass
Caro's Leading Jeweler
Phone 673-2444

ANTIQUE and COLLECTORS FAIR

Sunday, Nov. 25 - 1979
10 a.m. till 6 p.m.
with Antique Auction to follow at 7:00 p.m.
Old Cass City Lanes
4533 Weaver Street
Cass City

November Radio Shack SHOPPER Specials

6-Band Portable Radio

Patrolman® CB-60 by Realistic®

Save \$30
69⁹⁵ Reg. 99.95

Hear all 40 CB channels. Monitor police and fire calls, aircraft, National Weather Service on VHF. Enjoy AM, FM and more. AC operation or batteries (not incl.). 12-766

Deluxe AM/FM Clock Radio

Chronomatic®-208 by Realistic

Save 24% **41⁸⁸** Reg. 54.95

What a surprise to wake up to on Christmas morning! Snooze control lets you catch extra winks in the morning. Sleep control gives you a timed "serenade" to fall asleep. Slide-rule dial, earphone jack. 12-1513

MASIMO CARD VISA CHARGE IT

Realistic Cassette and 8-Track Recording Tape

40-Min. 8-Track	80-Min. 8-Track	60-Min. Cassette	90-Min. Cassette
1⁴⁹ Reg. 1.99	1⁹⁴ Reg. 2.59	1⁴⁰ Reg. 1.89	1⁹⁴ Reg. 2.59
44-840	44-841	44-602	44-603

Walkie-Talkie

TRC-81 by Realistic

Save 36%
15⁸⁸ Reg. 24.95

Includes Channel 14 crystals. Add optional-extra crystals for up to 2 more channels. Batteries extra. 21-1603

Stereo Headphones

Nova®-10 by Realistic

15⁹⁵

Vinyl Headband

High quality at a budget price. Cushioned earpads and adjustable headband give you a natural fit for listening comfort. 33-1012

Calculator with Memory

EC-219 by Radio Shack

Save 27%
10⁸⁸ Reg. 14.95

A small price for a lot of calculating power! Eight digit display Batteries extra. 65-603

Hear Local "Action" on a Scanning Radio

PRO-53 by Realistic

- 4 Bands
- VHF-Hi/Lo
- UHF-Hi/Lo

149⁹⁵

A radio that lets you hear police, fire, rescue teams, railway communications and more. Scans and automatically locks in on any active channel, then resumes scanning at end of message. 20-122

Open Sunday
Nov. 25
12-4 p.m.
Dec. 2
9-16
23

Triple-Play AM/FM Recorder

CTR-46 by Realistic

59⁹⁵

End-of-tape Auto-Stop, Auto-Level. AC operation or batteries (not incl). 14-839

Cassette Recorder

CTR-43 by Realistic

29⁹⁵

Features built-in mike, Auto-Level, Auto-Stop, Batteries extra. 14-879

Instant Credit

Schneeberger's

TV APPLIANCES FURNITURE

Phone: 872-2696

Cass City

VISA

Master Charge

Vitamins at Coach Light Cost Less

You Buy The Discount Way

Natural Unprocessed Bran	500 MG 300 Tabs	\$2²²	\$3.49 Value	
Vitamin E	400 Units 100 Caps	\$5⁸³	\$7.99 Value	
Magnesium	250 MG 100 Tab	\$1⁰⁹	\$1.98 Value	
Vitamin C Rose Hips	Sustained Nutritional Release With 60 Tabs 1000 MG	\$2⁵⁹	\$4.99 Value	

COACH LIGHT PHARMACY

MIKE WEAVER, Owner Ph. 872-3613

Emergency Ph. 872-3283

Your Family Discount Drug Store

Discover **BEN FRANKLIN** We bring variety to life!



DELUXE AGGRAVATION Reg. \$5.99
Combines skill, strategy and a shortcut option for a new playing concept!
497 each

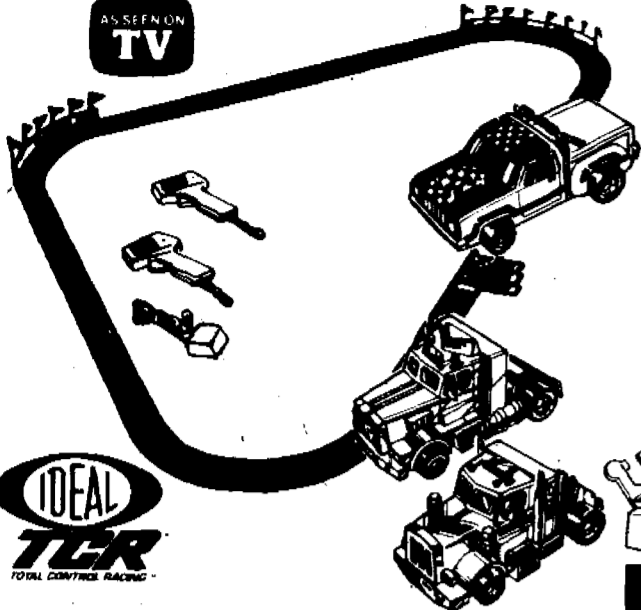

JAM TRUCKING SPEEDWAY RACE SET
HO scale big rig racing! Includes 2 trucks, 1 pick-up, over 18-ft. track, with controllers, accessories.
Reg. \$49.99
4497 set

Games!

CHALLENGING! ENTERTAINING!
BIG SELECTION! LOW PRICES

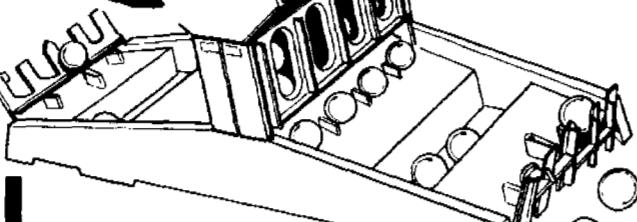

KEMER BALLS A POPPIN
Offense or defense firing of balls to center! Winner gets 4 balls in a row.
Reg. \$10.99
897 each

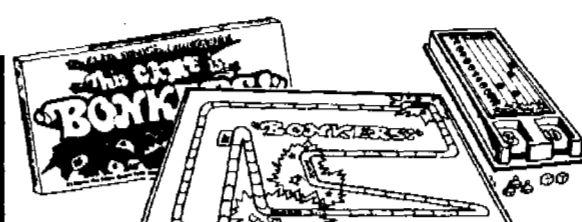

BONKERS
A zany, unpredictable game! Create the board as you play so it's never the same.
Reg. \$8.99
647 each

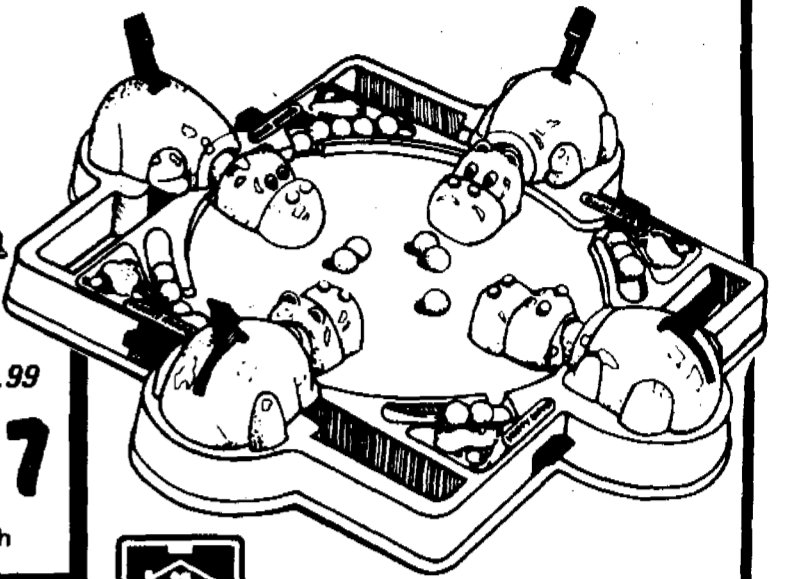

HUNGRY HUNGRY HIPPO
The action is fast and frantic as your hippo reaches out and "swallows" the last marble.
Reg. \$13.59
Now Only
1097 each



BIG SELECTION POCKET GAMES
Choose from 6 exciting games involving sports, chance, skill, more!
Reg. \$1.59
127 each



BOGGLE WORD GAME
Race against time to formulate words with 16 lettered cubes!
Reg. \$6.99
547 each

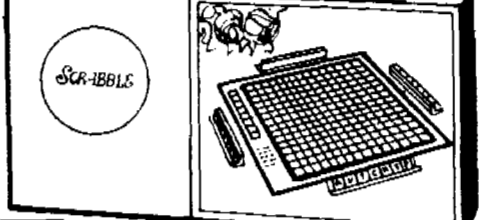

FAMOUS SCRABBLE
Spelling is fun with scrabble, the crossword game.
Reg. \$7.99
547 each

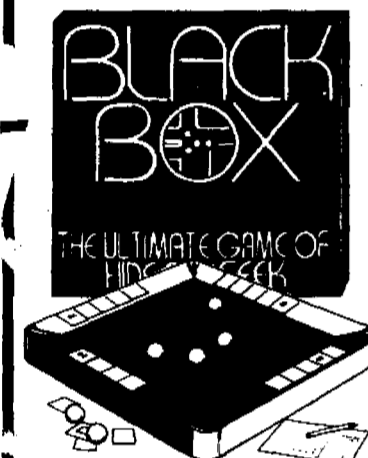

BLACK BOX
Powerful game of logic and deduction! Strategy game of hide and seek!
Reg. \$8.99
597 each



POP-O-MATIC PIN BALL GAMES
Your choice of 3 different games for hours of fun anywhere!
Reg. \$3.49
277 each



Mad Magazine GAME
Crazy game of mixed-up logic. Players travel backwards around the board. First player to lose all money, wins!
Reg. \$8.99
Now Only
647 each

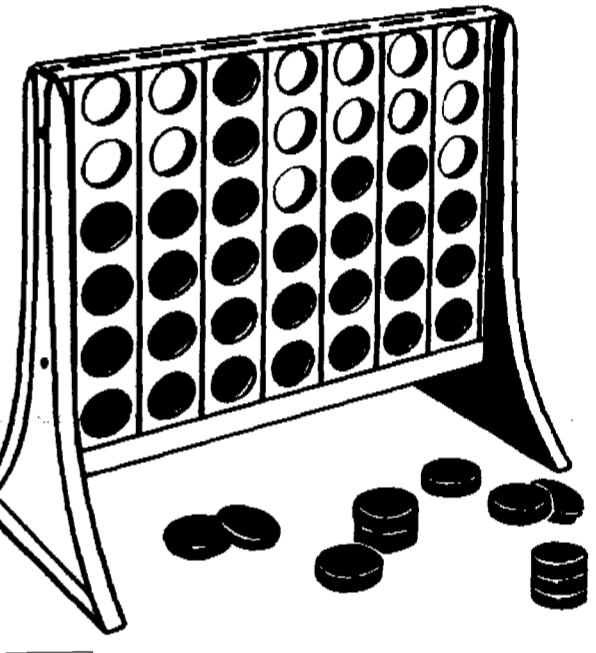

CONNECT FOUR
Object is to get 4 checkers in a row! Complete with 42 checkers, play frame, stand.
Reg. \$7.49
547 each



FAMILY GAMES
Two long-time family favorites, Monopoly and Sorry! Both provide hours of fun. 2 to 8 players.
136,139
Choice
577 each



YAHTZEE GAME
The family-fun game that makes thinking fun! Ages 8 and up.
Reg. \$3.59
297 each



COMPUTER PERFECTION
Complete electronic family game! Four different games and skill levels to challenge your mind and memory! Play against the computer or a friend! It keeps score for you! Uses 9-volt batteries (not incl.).
Reg. \$37.99
Now Only
3397 each

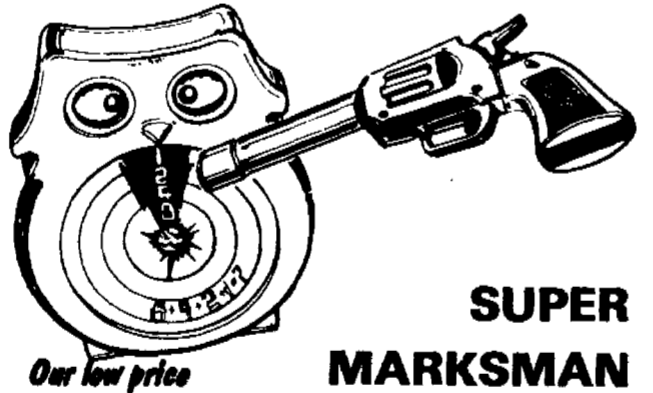

SUPER MARKSMAN
Has built-in scoring system! Includes a light-beam pistol and target... sound effects, too!
Our low price
1297 each



Kodak Ektralite 10 CAMERA OUTFIT
Has built-in electronic flash, 2 shutter speeds, sliding lens cover! Includes C110-20 film and two "AA" batteries.
Reg. \$31.99
Now only
2697



ELECTRIC TRAIN SET WITH NIGHT-GLOW
HO scale. Includes lighted locomotive, piggy-back loader/unloader, depot, 5 freight cars and much, much more! 36x45-in. oval track.
Reg. \$34.99
2997 set



Electronic Board Game STOP THIEF
Scanner gives "detective" sound-effect clues... with logic, deduction attempt to capture computer thief!
Our low price
2497 each

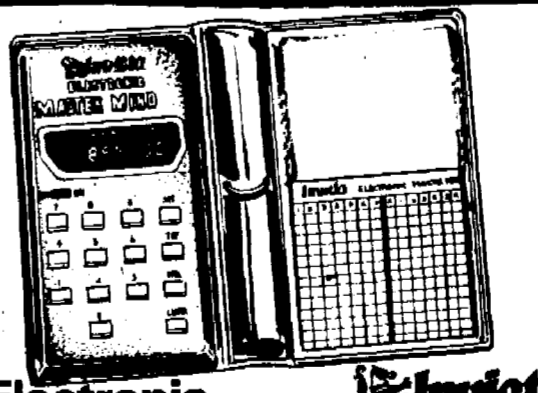

Electronic MASTER MIND
Play several different games alone or with opponent! Includes carry case, pen and pad.
Our low price
2297 each

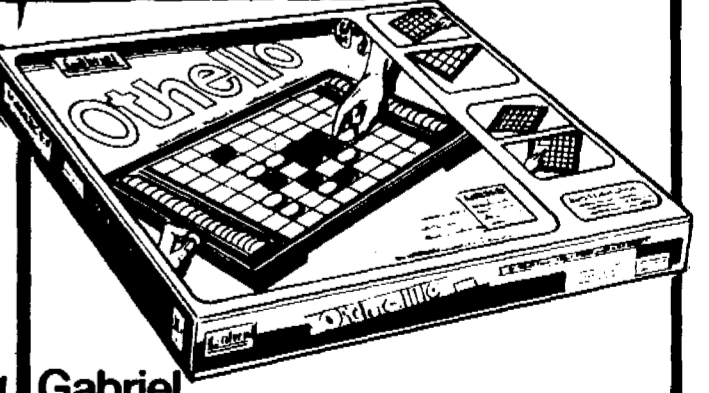

OTHELLO
Board game that's as easy as checkers with endless strategic possibilities! Great family game!
Our low price
888 each

Discover **BEN FRANKLIN** We bring variety to life!

Where everything you buy is guaranteed. Cass City



Altar Society makes plans

St. Michael's Altar Society meeting was held Nov. 12. Father William O'Shea opened with prayer. Reports were read and approved. The Thanksgiving drive will be the week of Nov. 26-Dec. 1. Sorting and packing will take place the following week. Election of officers will take place at the Dec. 10 meeting. Virginia Bilicki and Arlene Marz volunteered for the nominating committee.

The Christmas party will take place at this time also. Baked goods for exchange of gifts was suggested and approved. Everyone is to bring a dessert dish for the party also.

Discussed was buying the Christmas trees for the church.

The meeting was closed with prayer for the repose of Chet Karpowski's soul. Refreshments were served.

HEALTH TIPS

Take it easy when shoveling snow

Frank Chappell
Science News Editor

Winter snows are almost here again, and millions of householders will be faced once more with clearing walks and driveways.

Snow shoveling requires a lot of energy and muscle. Pushing a stalled auto out of a drift is even more demanding.

Once again the American Medical Association reminds men of middle age and beyond, especially those who are overweight and lead sedentary lives, to take it easy in clearing away the snow from walks and drives.

If you're in good health, snow shoveling actually is good exercise - if you take it easy. This could mean getting up half an hour earlier on the morning of a fresh snow fall, to allow time

for leisurely shoveling, with frequent brief rests. The frantic, hurried approach to clearing the drive in an effort to get to work on time most definitely is not good for health.

Most common serious health result of overexertion from snow shoveling is a heart attack. If your heart is sound, it likely won't be damaged. But if you already are prone to a heart attack, the extra exertion can trigger it.

Unless you have had a recent checkup, however, you cannot be certain you aren't a likely candidate for heart trouble. Take it easy. Don't be ashamed to invest in a machine that blows or scrapes aside the snow, with a small engine substituting for muscle power. Or hire the neighborhood lad down the street to shovel your walks.

Snow shoveling can be good for you, if you use common sense. Exercise and fresh air in the winter are important to maintaining health. Just don't overdo it.

Formal Wear
Chappell's
Men's Wear and Formal Wear Rental
Phone 872-3431



AARP has Thanksgiving dinner

The annual Thanksgiving dinner of the Cass City chapter of the American Association of Retired Persons was held Nov. 8 at the Good Shepherd Lutheran church fellowship hall.

The Lutheran Ladies Aid Society was in charge of the dinner.

Members and guests were entertained by the G.E.T. muppet ministry "God's Everlasting Team." Muppets were Becky Nye, Karen Little, Becky Speirs, Scott Hartwick and Rob Hartwick, with Donna Little and Donella Peasley in charge of production.

The Cass City Rotary Club has invited the AARP members to be guests at the annual Rotary Christmas party at Cass City High School, Thursday, Nov. 29, at 6 p.m. Members must be wearing their identification badges.

Dec. 13 will be the next regular meeting at the fellowship hall. There will be a Christmas exchange. Rose Worstell, Mr. and Mrs. Luther Durham, Donna Wernette and Leona Stevens will be in charge of arrangements.

Big Brothers/Big Sisters

A very active 15-year-old from Vassar has been waiting for a Big Sister well over a year. She likes all sports, hiking, and swimming. She is a sweet girl with some very special needs.

at 129 E. Burnside Street, Caro, telephone 673-6996; in Sanilac county at 26 Lexington Street, P.O. Box 1, Sandusky, telephone 648-4433; in Huron county at 592 N. Port Crescent, Bad Axe, telephone 269-7264.

+++++

We have a 12-year-old boy who would love the company of an understanding Big Brother. He lives in Caro and enjoys camping, sports, skating, fishing and bike riding.

+++++

A lot of special attention is needed from a man for this little eight-year-old boy. He comes from a large family in Unionville, and enjoys building things, playing football and basketball.

+++++

A mechanical minded boy from the Millington area needs a Big Brother. He is 15 years old and likes fishing, working with dogs, and hunting. This Big Brother will need lots of patience and understanding.

+++++

Big Brothers-Big Sisters in Tuscola county is located

Hairstressers pick favorite style makers

The National Hairstressers and Cosmetologists Association, affiliate No. 25, met recently.

Members voted on the style maker of the year for 1980.

The three top choices were Lauren Tewes, Carol Burnett and Polly Bergen.

The members also donated money to the NHCA disaster fund and scheduled the Christmas party Dec. 10 at Veronica's Restaurant in Cass City.

All licensed hairstresser and cosmetologists are welcome to join NHCA. Contact Helen's Beauty Shop in Cass City.

Crisis Center meeting set

The Tuscola County Assault Crisis Center will meet Tuesday, Nov. 27, at 7:30 p.m. at the Sacred Heart Parish Center in Caro.

A board of directors will be elected and training sessions for volunteers will be discussed.

ANTIQUE and COLLECTORS FAIR
Sunday, Nov. 25 - 1979
10 a.m. till 6 p.m.
with Antique Auction to follow at 7:00 p.m.
Old Cass City Lanes
4533 Weaver Street Cass City

Advertise It In The Chronicle.

Homeowners' Insurance

Is your home 15 years or less?
Do you carry \$40,000 or more coverage?
If so - give us a call.
We should save you money on your insurance.

Doerr Insurance
6265 Main Cass City
Call 872-3615 for a quote

PRE-Christmas Sale

Friday - Saturday, Nov. 23 - 24 Only

Infants' **SLEEPERS**

One Piece

Slightly Irregulars, 100% Polyester.
Flame Resistant. Assorted Solid Colors and Prints.

Sizes: Small, Med., Large

2 for \$3.67



Women's **ANKLE LENGTH DRAWERS**

50% Polyester, 50% Cotton

Warm ankle length under drawers for the cold winter days. Assorted solid colors.

Slight Irregulars
Sizes: S-M-L-XL

\$2.99 ea.

ONLY



BED BLANKETS

"Frosty" 100% Polyester - All Nylon Binding
Non-allergenic, Machine and Hand Washable, Fits Full and Twin Size Beds.

SIZE 72" x 84"

\$3.99 Ea.

75 Blankets Only

Limit 3 To Customer
Sale Ends Sat., Nov. 24



Ladies' Sleepwear **LONG BRUSHED GOWNS**

80% Acetate, 20% Nylon

Prepare for the long cold winter nights with a warm long gown now priced to save \$\$\$.

Assorted Solid Colors
Sizes: S-M-L-XL
96 Gowns
Only Available

\$3.99 ea.

Hurry!



Men's Work **COVERALL SALE**

By "Dickie" and "Lee"

Colors: Fisher Cloth, Spruce, Brown, Navy

Shorts..... Sizes 38-46
Regulars..... Sizes 34-54
Longs..... Sizes 38-54

\$2.00 Off

REGULAR PRICE
Sale Ends Saturday, Nov. 24



MEN'S INSULATED **8-inch Shoes**

- SPORT OR WORK
- LEATHER UPPER AND LEATHER LINED

Entire Stock Reduced

\$5.00

From Our Already Low Prices
2 Days Only, Nov. 23-24
Don't Miss Out On This One



KRITZMANS' INC.

CASS CITY PHONE 872-3470



Register For Free Florida Trip And "Lucky Bucks" At Our Store

Free Sunday Coffee Tickets

Cass City Bowling Leagues

TUESDAY AFTERNOON LADIES Nov. 13, 1979		Central Builders 2 Woods Hay & Straw 0 Veronica's 0 Cablettes 0	High Team Game: Hillaker's 991. 210 Games: D. Wallace 226, M. Patrick 220, K. Hall 224, B. Biebel 223, C. Comment 212, N. Willy 239-213, L. Summers 226-234, M. Irrer 222, B. Freiburger 210. 550 Series: D. Wallace 627, L. Tomaszewski 556, J. Schwartz 568, B. Albrecht 595, N. Willy 627, L. Summers 659, M. Irrer 579.
Caro Honda Sales 37 Lucky's Kountry 30 Korners 30 The Four of Us 23 1/2 Don's Auction Gallery 23 Lucky Losers 23 Bowling Grannies 22 Our Team 21 The Ups & Downs 19 1/2 Gofer Mores 18 Cass City Rollers 17 Cass City-Ann's 16 The Hair Benders 14		Team High Game: Brinkman Bins 819. Team High Series: Brinkman Bins 2410. High Series: S. Reynolds 535, M. Guild 523, J. O'Dell 508, M. Smithers 502, C. Wallace 500. High Games: M. Guild 205.	TUSCOLA GET TOGETHERS "A" End of First Round Miller's Egg Inc. 61 Dale's Eaves Trough 52 Thumb Leasing 49 Chappel's Men's Wear 46 Farmers & Merchant's Bank 39 Farm Bureau 38 Mr. Kelly's 34 Larry's Carwash 33 Bliss Milk Haulers 32 Kilbourn Tech. Sup. 30 Nancy's Rest. 27 Rogers' Hay 21 High Series: J. Zawilinski 531. High Game: B. Zawilinski 207. High Team Series: Chappel's 2389. High Team Game: Chappel's 845.
CHARMONT LADIES Nov. 13, 1979		Brinkman Bins 4 Fort's 4 Gagetown Oil & Gas 4 Live Wires 2 Johnson Six 2 Erla's 2 IGA Foodliner 2 Cass City Sports Inc. 2	TUSCOLA GET TOGETHERS "B" End of First Round Maurer Const. Co. 52 Charmont 47 Hillaker's Auct. Serv. 45 Hall's Trim Shop 44 Walbro Far East 43 Harris-Hampshire Ins. 41 Sugar Town Market 38 Cole Carbide 37 Ouvry Chevy-Olds 37 Fire House No. 1 29 Sommer's Bakery 27 Lawrence Ins. 26 High Series: L. Summers 659. High Game: N. Willy 239. High Team Series: Char-mont 2882.

FRIDAY NIGHT DOUBLES Nov. 16, 1979		Gutter Dusters 28 1/2 Wild Turkeys 25 1/2 Strikers 23 3 Bs & C 23 Funny Four 23 Golden Nugget 23 Caro Comics 22 Holloway Fire 21 1/2 Heard's Tears 20 Alley Bombers 19 Sawdusters 18 1/2 P.M.s 17	Men's High Series: K. Maharg 563. Ladies' High Series: N. Maharg 517. Men's High Game: K. Maharg 219. Ladies' High Game: N. Maharg 211. High Team Series: Kens & Kerbs 1934. High Team Game: Kens & Kerbs 720. Men's 210 Games: K. Maharg 219-206, E. Bilicki 210. Men's 500 Series: L. Phillips 502, K. Maharg 563, C. Kolb 519, E. Bilicki 516.
FRIDAY NITE CARCASS UNION Nov. 16, 1979		Rescue Squad 34 Fishbowlers 33 Gutter Dusters 25 Old Folks 25 Cannonballs 24 1/2 Ballbusters 23 Krauts 22 Fruit of the Loom 19 1/2 Turkeys 18 Slow Rollers 17 Lucky's Kountry 12 Korner 12 Crowbars 11	FRIDAY NIGHT DOUBLES Nov. 16, 1979 Men's High Series: S. Fobear 613. Men's High Game: B. McPhail 234. Ladies' High Series: G. Fruchey 480. Ladies' High Game: G. Fruchey 185. High Team Series: Holloway Fire 1987. High Team Game: Holloway Fire 655. 200 Games: B. McPhail 234, S. Fobear 207-209. Men's 550 or Better: B. McPhail 573, S. Fobear 613.

Professional and Business DIRECTORY

DR. W. S. SELBY Optometrist Hours: 8-5 except Thursday 9-12 noon on Saturday 4624 Hill St. Across from Hill and Dale's Hospital Phone 872-3404	DR. E. PAUL LOCKWOOD Chiropractic Physician Office Hours: Mon., Tues., Wed., Fri. 9-12 noon and 1:30-5:00 p.m. Saturday 9-12 a.m. Closed All Day Thursday Phone 872-2765 Cass City, for Appointment
Allen Witherspoon New England Life NEL Growth Fund NEL Equity Fund Value Line Fund Keystone Funds Phone 872-2321	Harold T. Donahue M.D. Physician & Surgeon CLINIC 4674 Hill Street, Cass City Office 872-2323 Res. 872-2311
K. I. MacRae, D.O. Osteopathic Physician and Surgeon Corner Church and Oak Streets Office 872-2880 Res. 872-3365	Harris-Hampshire Agency, Inc. Complete Insurance Services 6815 E. Cass City Road Cass City, Michigan Phone 872-2688
Sang H. Park, M.D. Obstetrics & Gynecology 4672 Hill Street Phone 872-2800 Office Hours by Appointment	Sabb A. Isterbach, M.D., FRCS 4674 Hill Street Cass City, Michigan 48726 Surgeon, General & Thoracic Outpatient Clinic Hills & Dale's Hospital Each Wednesday 8 a.m. - 1 p.m.
James Ballard, M.D. Office at 4530 Weaver Street Hours: 10:00 a.m. to 12:00 noon 2:00 p.m. to 4:30 p.m. Daily except Thursday afternoon	Dr. J. Geissinger CHIROPRACTOR Mon., Tues., Thurs., Fri. 9-12 a.m. and 2-6 p.m. Sat., 9-12 a.m. 21 N. Aimer, Caro, Mi. Across from IGA Store Phone Caro 673-4464
DO YOU HAVE A DRINKING PROBLEM? ALCOHOLICS ANONYMOUS and AL-ANON Every Friday Evening - 8:00 p.m. Good Shepherd Lutheran Church Cass City	Hoon K. Jeung, M.D. General Surgery 9 a.m. - 5 p.m. Daily Saturday - 9 to 12 noon Office Hours by Appointment Phone 872-4611 4672 Hill St. Cass City, Mich. 48726 Home 872-3138
Edward Scollon, D.V.M. Veterinarian Call for Appointment for Small Animals Phone 872-2935 4849 N. Seeger St., Cass City	Harry Crandell, Jr. D.V.M. Office 4438 South Seeger St. Phone 872-2255
Richard A. Hall, D.O. Osteopathic Physician 4672 Hill Street Cass City, Michigan Office 872-4725 Home 872-4762	

POLE BUILDINGS

CUSTOM DESIGNED COMMERCIAL and FARM BUILDINGS

- *Machinery
- *Fertilizer
- *Storage
- *Animal Housing
- *Garage

WE SPECIALIZE IN COMMERCIAL BUILDINGS
"Ask The Farm Bureau People"
FARM BUREAU BUILDINGS
ANTON PETERS
5822 Cass City Rd.
Cass City, Mich.
Phone (517) 872-4409

Think Snow... and Save

JACOBSEN SNO-BURST

SNOW THROWER
Sno Burst features a powerful 3-hp engine, with Power Burst™ for increased engine rpm's and faster paddle action to clear drifts and deep snow right down to the pavement. WN1/51610

- Jacobsen 2-cycle engine
- Aluminum impeller
- Enclosed belt drive for quiet operation
- 2-qt. fuel tank means fewer fillups
- 50:1 gas/oil ratio for less smoking
- 90° directional control
- Easy-access control panel
 - 2-position adjustable handle
 - Key switch, recoil starter
 - 7-in. wheels

269.95

Extended Sale Prices On Snow Blowers by Jacobsen or Lawn Boy
SAVE OVER \$40⁰⁰ On Either Model

Albee Home Center
Cass City Phone 872-2270



THURSDAY MORNING COFFEE LEAGUE Nov. 15, 1979		Pinney State Bank 10 Pin Pals 8 Shirley's Salon 8 Deering Packing 8 Rabideau's Girls 8 Pilots + 1 7 Kingston State Bank 6 Youngsters 5 Deford Country Grocery 4 Happy Hoofers 4 Odds & Ends 2 Deering Farms 2	MERCHANTS' "B" LEAGUE Final Standings Round 1 Nov. 14, 1979 Rabideau Motors 30 Charmont 30 Gagetown Oil & Gas +26 Clare's Sunoco 24 1/2 Tuckey Concrete 22 Spencer's Masonry 21 1/2 Colony House 21 Bauer Candy Co. 21 Copeland Builders 19 General Cable 18 Herron Builders 18 Shag's Angels +9 +Games to be made up.
THURSDAY MORNING COFFEE LEAGUE Nov. 15, 1979		500 Series: G. Corcoran 555, L. Selby 554, Pat McIntosh 512. 200 Games: G. Corcoran	MERCHANTS' "B" LEAGUE Final Standings Round 1 Nov. 14, 1979 500 Series: M. Sontag 586, J. Zornow 579, D. Miller 578, R. Nicholas 562, B. Davidson 561, G. Diebel 558.

CHRONICLE WANT ADS

SELL HOMES AND BUILDING MATERIALS, TOO

IT ONLY TAKES....

2 BUCKS

3 BUCKS

4 BUCKS

5 bucks, 10 or 20 bucks a week to join our Christmas Club. You'll get a FREE gift and we'll pay the 50th and last payment to your account.

CASS CITY BRANCH

THUMB NATIONAL BANK AND TRUST COMPANY

6128 E. Cass City Road
FREE CHECKING - NO MINIMUM, NO SERVICE CHARGE
HOURS: Mon.-Thurs. 9-4 - Fri. 9-8 - Sat. 9-12
Phone 872-4311

GIFTS OF LOVE by *Priscilla*

FROM

McCONKEY
JEWELRY & GIFT SHOP

6458 MAIN STREET
CASS CITY, MICHIGAN 48726

A GIFT FROM McCONKEYS JEWELRY IS ALWAYS SOMETHING SPECIAL

"what a lovely way
to say I love you . . ."

Carol Channing



gifts of love from... Priscilla® Diamonds

The Perfect Symmetry of Precious Gems . . . in Unique Settings

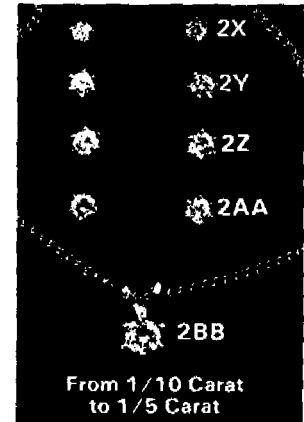
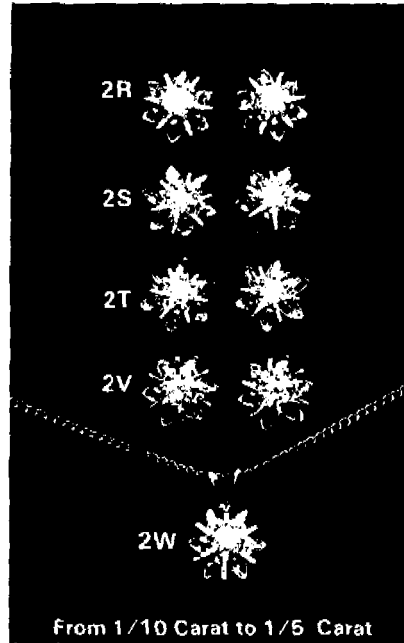
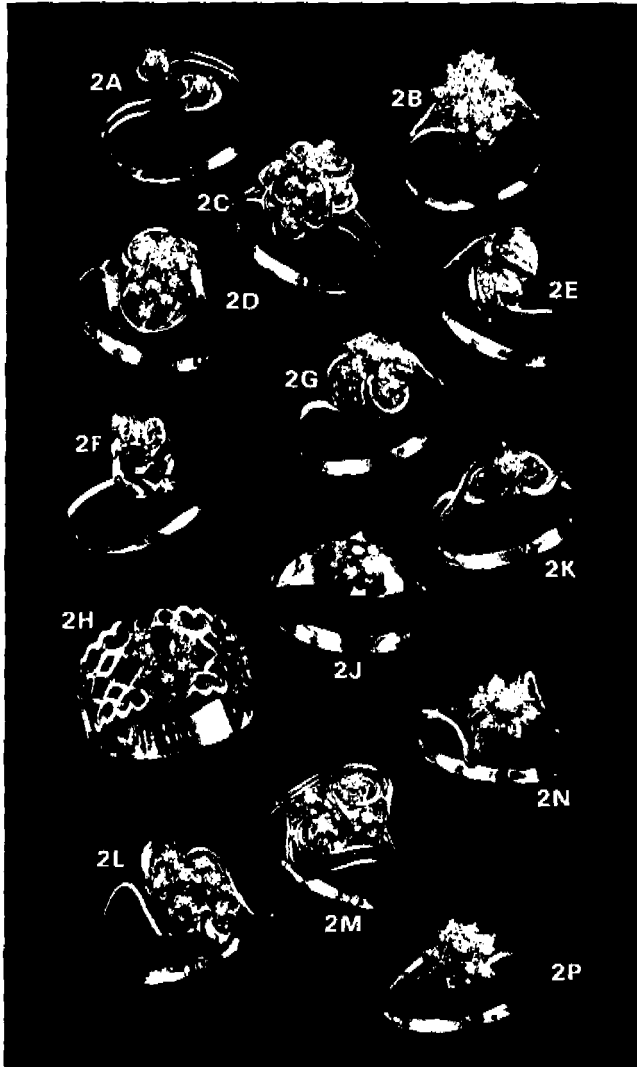

2A. 14K Yellow Gold; 2 diamonds .	\$233.75	2W. 14K White Gold	\$152.50
2B. 10K White Gold; 20 diamonds .	\$825.00	2X. 14K White Gold	\$137.50
2C. 14K Yellow Gold; 11 diamonds .	\$350.00	2Y. 14K White Gold	\$165.00
2D. 10K Yellow Gold; 13 diamonds .	\$517.50	2Z. 14K White Gold	\$192.50
2E. 14K Yellow Gold; 6 diamonds .	\$250.00	2AA. 14K White Gold	\$225.00
2F. 10K White Gold. 3 diamonds .	\$204.50	2BB. 14K White Gold	\$275.00
2G. 14K Yellow Gold. 13 diamonds .	\$500.00	2CC. 14K White Gold; diamonds .	\$107.50
2H. 14K Yellow Gold. Ruby/8 dia. .	\$512.50	2DD. Necklaces (matches 2CC) . .	\$100.00
2J. 10K Yellow Gold. Ruby/6 dia. .	\$267.50	2EE. 14K Yellow Gold; diamonds .	\$150.00
2K. 14K White Gold. Dia./4 saph. .	\$250.00	2FF. Necklace (matches 2EE) . . .	\$125.00
2L. 14K White Gold. 7 diamonds .	\$375.00	2GG. 14K Yellow gold; diamonds .	\$125.00
2M. 10K White Gold. 4 diamonds .	\$187.50	2HH. Necklace (matches 2GG) . .	\$132.50
2N. 10K White Gold. 7 diamonds .	\$292.50	2JJ. 14K Yellow Gold; diamonds .	\$178.75
2P. 10K White Gold. 11 diamonds .	\$417.50	2KK. Necklace (matches 2JJ) . . .	\$132.50
2R. 14K Yellow Gold	\$202.50	2LL. 14K Yellow Gold; diamonds .	\$132.50
2S. 14K Yellow Gold	\$272.50	2MM. Necklaces (matches 2LL) . .	\$100.00
2T. 14K White Gold	\$178.75	2NN. 14K W.G.; dia/cult; pearl . .	\$162.50
2V. 14K White Gold	\$227.50	2PP. Necklace (matches 2NN) . . .	\$100.00



WEIGHT MARKED® Diamonds

by *Priscilla*

For your protection, the exact weight of the center stone of our engagement rings . . . to one-hundredth of a carat . . . is stamped in the shank of the ring. Ask to see a WEIGHT MARKED® Diamond by Priscilla®.



3A

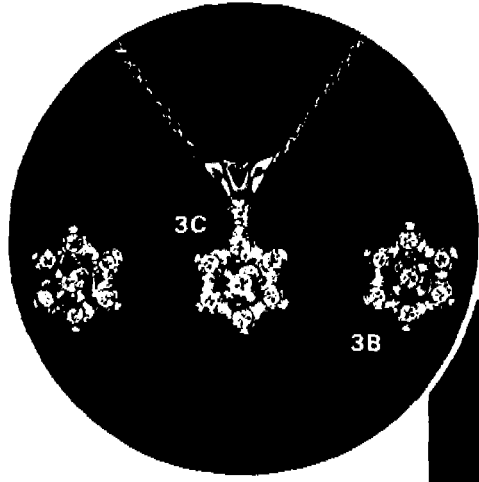

3C

3B



3D

3E

3F

From 1/5 Ct. to 1 Ct. Total Weight



3G

3H

3J

3K

3L

3N

3M

the many facets of love

3A. Gleaming 14K yellow gold engagement ring with solitaire diamond . . . \$337.50

Matching 14K white gold and diamond "Snowflake" ensemble is sure to warm her heart.

3B. Pierced earrings with 14 diamonds \$215.00

3C. Pendant with seven diamonds . . . \$135.00

Matching 14K yellow gold lover's hearts each with a glistening diamond.

3D. Lover's pendant . . . \$107.50

3E. Lover's pierced earrings . . . \$125.00

3F. Lover's ring . . . \$212.50

3G. Ladies' 14K white gold dinner ring with nine diamonds . . . \$1142.50

3H. Swirling 14K yellow gold ring with seven diamonds . . . \$617.50

3J. A rosebud of seven diamonds bloom upon a 14K yellow gold setting . . . \$375.00

3K. Men's 10K yellow gold ring with seven diamonds . . . \$442.50

3L. Ladies' 14K white gold diamond duo with seven diamonds. Eng. \$227.50 Wed. \$152.50

3M. Five glistening diamonds adorn this ladies' 14K white gold ring . . . \$367.50

3N. Ten bewitching diamonds enhance this ladies' 14K white gold ring . . . \$442.50

3P. Men's 10K yellow gold diamond ring with two sparkling diamonds . . . \$450.00

3R. Three glistening diamonds adorn this 10K yellow gold ring . . . \$367.50

3S. One naturally beautiful diamond adorns this 10K yellow gold men's ring . . . \$233.75

3T. Men's 10K yellow gold ring with one sparkling diamond . . . \$350.00

3U. Seven sparkling diamonds adorn this men's 10K yellow gold ring . . . \$392.50

3V. Men's 10K yellow gold diamond ring with one center diamond . . . \$282.50

3W. One gleaming diamond enhances a 10K yellow gold band . . . \$275.00

3X. Three diamonds and one genuine ruby highlight a 14K yellow gold pendant . . . \$275.00

3Y. The butterfly of love holds three diamonds in this 14K yellow gold pendant . . . \$287.50

3Z. Three diamonds enhance this 14K yellow gold avante garde pendant . . . \$312.50

3AA. Men's 10K yellow gold ring with five diamonds . . . \$600.00



3AA

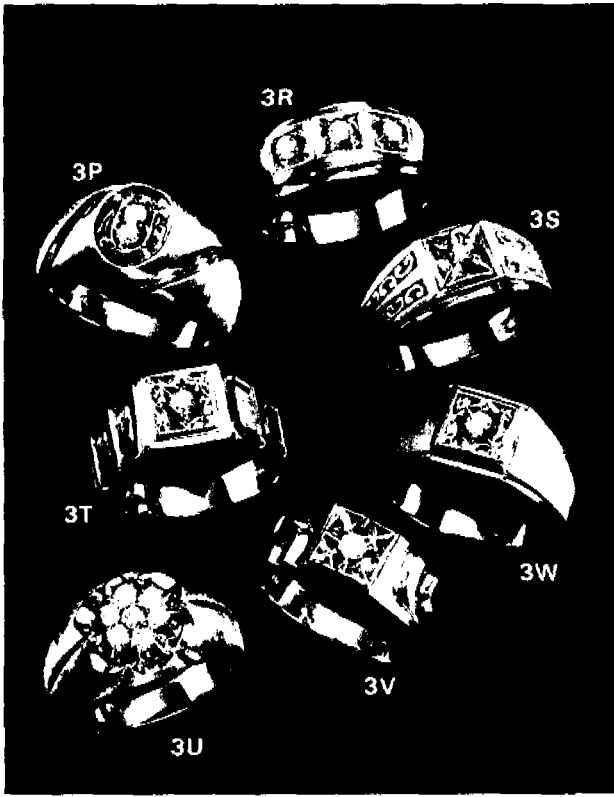

3R

3P

3S

3T

3W

3U

3V



3X

3Y

3Z

JEWELRY SHOWN ON FRONT COVER:

14K yellow gold and amethyst slide necklace. Exquisite simplicity! . . . \$329.95

14K yellow gold and ruby ring with eight sparkling diamonds . . . \$512.50

10K white gold ring with twenty glistening diamonds . . . \$825.00

10K men's yellow gold ring with five sparkling diamonds . . . \$600.00

14K rose gold ring w/diamond . . . \$164.95

Ladies' watch with mesh bracelet . . . \$67.50



Cindy and Keith McConkey

Priscilla
Diamonds
Diamond Jubilee

Dear Friends and Neighbors,

We are pleased to bring you our latest catalog for your gift and personal selection convenience. The catalog can only show a portion of all the fine jewelry and gifts on display in our store. We cordially invite you to visit us during the Holiday Season. As an independent Retail Jeweler, we offer many services and product categories to our customers. As you may not be familiar with those we do provide, a partial listing is shown below:

Our Best Wishes for a Joyous Holiday Season.

- **Diamond Setting services available.**
- **Ring sizing and jewelry repair.**
- **Diamond Appraisals** for estate and insurance purposes.
- **Guaranteed Diamond Value.** Today's purchase price is guaranteed as trade-in value for larger diamond purchases in the future.
- **Engraving done on the premises.** Hand and machine engraving are available to personalize your special jewelry and gift purchases.
- **Bridal registry.** The new bride's wedding gifts are carefully recorded to help avoid duplication. These records are maintained for future reference.
- **Class Rings.** High School and college rings available all year long.
- **Religious jewelry; medals, crosses, and rosaries.**
- **Sterilized ear piercing done on the premises.**
- **Total watch service available:** repair, reconditioning, cleaning, battery installation, and an excellent selection of ladies and mens watchbands
- **Free Gift-Wrapping.**
- **Credit Services:** 30 day accounts, revolving charges, bank financing MasterCard, Visa, American Express, Carte Blanche.

Keith D. McConkey

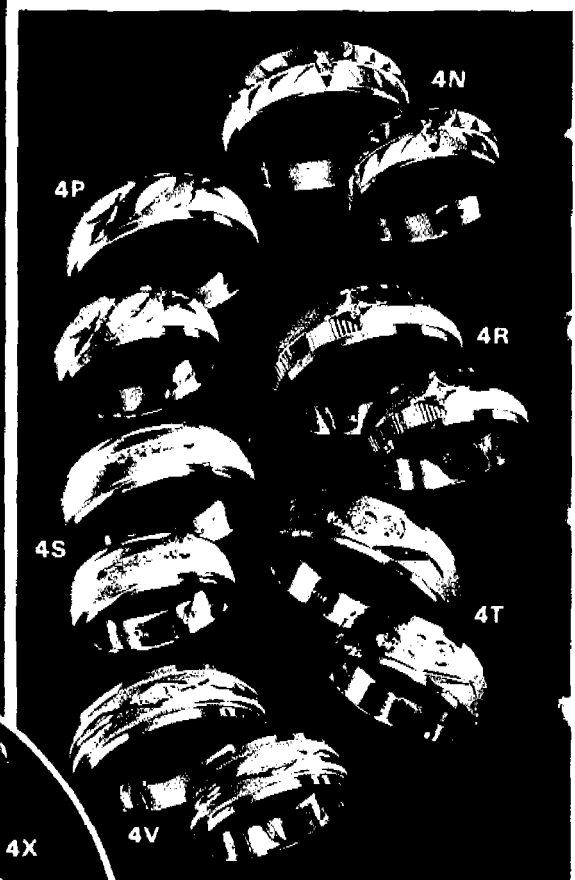
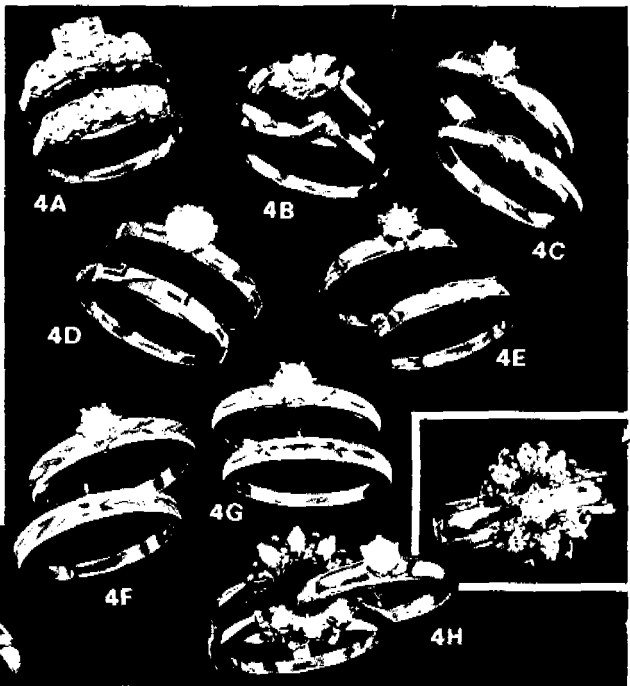

- 4A. 10K Yellow Gold Ring. Engagement \$145.75 Wedding \$91.25
- 4B. 10K White Gold Ring. Engagement \$250.00 Wedding \$87.50
- 4C. 10K White Gold Ring. Engagement \$145.75 Wedding \$77.50
- 4D. 10K Yellow Gold Ring. Engagement \$178.75 Wedding \$68.75
- 4E. 10K Yellow Gold Ring. Engagement \$118.75 Wedding \$67.50
- 4F. 10K Yellow Gold Ring. Engagement \$200.00 Wedding \$87.50
- 4G. 14K White Gold Ring. Engagement \$225.00 Wedding \$91.25
- 4H. 14K White Gold Engagement Ring Solitaire \$450.00
- 14K Yellow Gold Jacket Ring. 8 genuine rubies, 6 diamonds \$625.00
- 4J. 14K Yellow Gold Ring. Engagement \$212.50 Wedding \$125.00
- 4K. 10K Yellow Gold Ring. Engagement \$165.00 Wedding \$107.50
- 4L. 10K Yellow Gold Ring. Engagement \$125.00 Wedding \$68.75
- 4M. 10K Yellow Gold Ring. Engagement \$300.00 Wedding \$91.25
- 4N. 14K Yellow Gold His/Hers Wedding Bands. 2 diamonds each . . . \$225.00 each

- 4P. 14K Yellow Gold His/Hers Wedding Bands. 1 diamond each . . . \$212.50 each
- 4R. 10K Yellow Gold His/Hers Wedding Bands. 1 diamond each . . . \$165.00 each
- 4S. 10K White Gold His/Hers Wedding Bands. 5 diamonds each \$212.50 each
- 4T. 14K Yellow Gold His/Hers Wedding Bands. 3 diamonds each \$250.00 each
- 4V. 10K Yellow Gold His/Hers Wedding Band. 3 diamonds each . . . \$192.50 each
- 4W. 10K White Gold Ring. Eng. \$145.75 Wedding \$82.50 Grooms \$125.00
- 4X. 10K Yellow Gold Ring. Eng. \$145.75 Wedding \$82.50 Grooms \$125.00
- 4Y. 14K White Gold Ring. Eng. \$225.00 Wedding \$112.50 Grooms \$165.00
- 4Z. 10K Yellow Gold Ring. Eng. \$187.50 Wedding \$112.50 Grooms \$165.00

gifts that keep on giving.

for him...
for her...

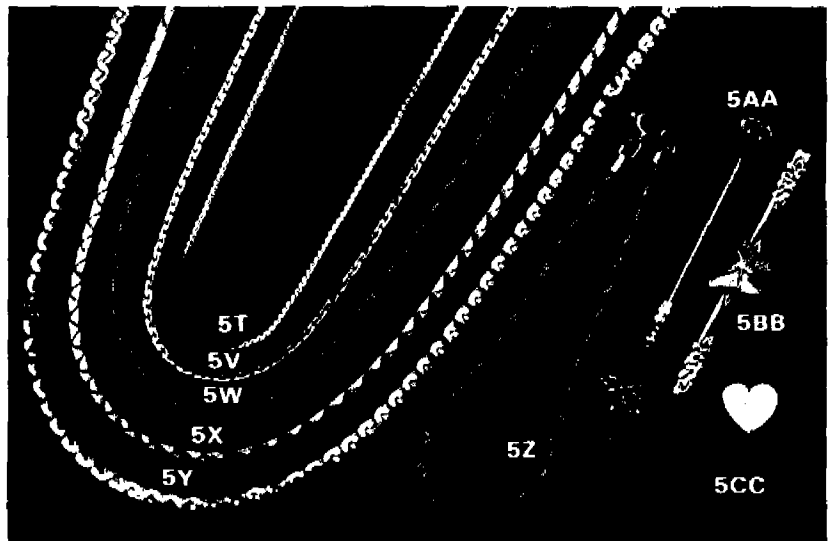
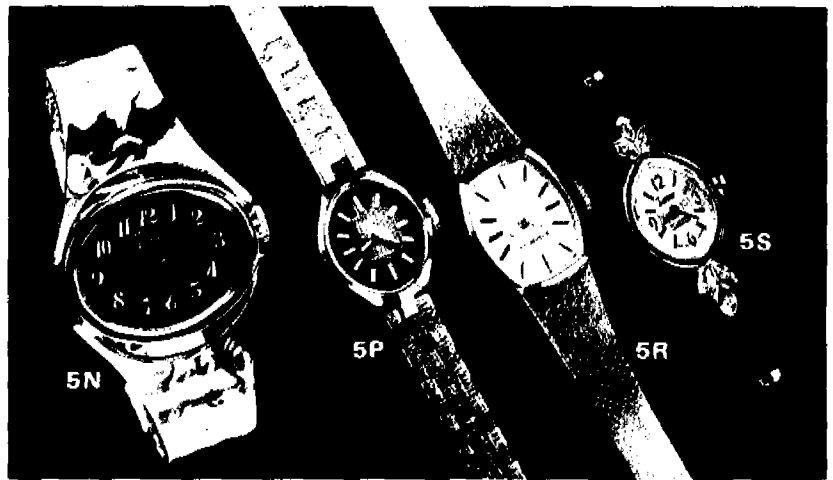
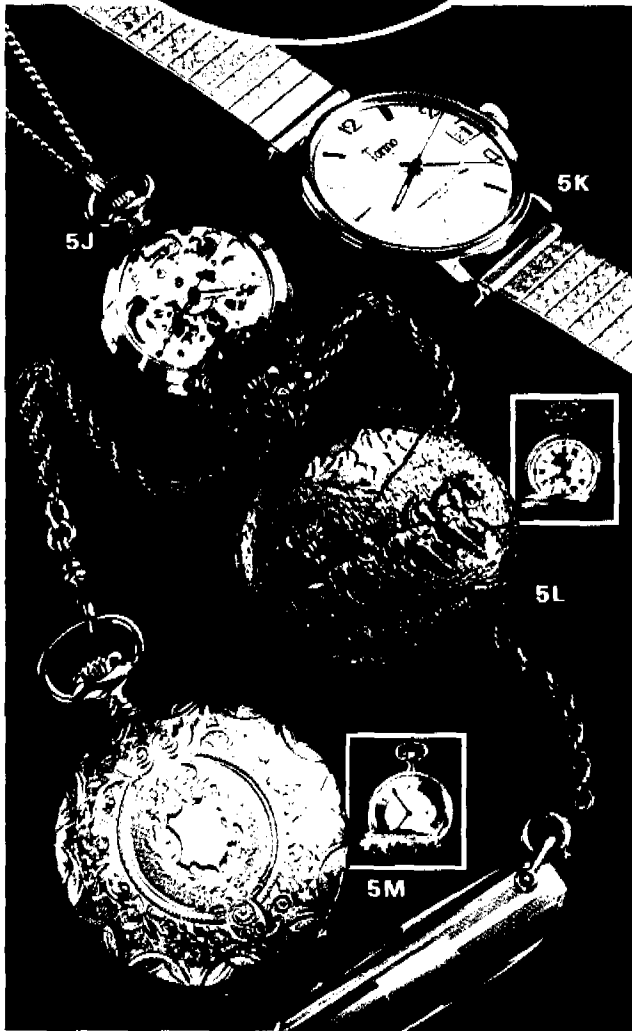
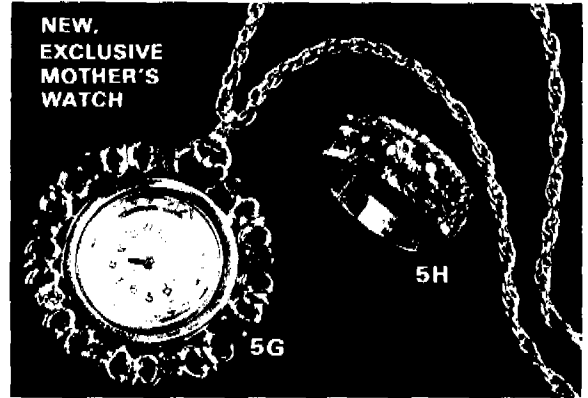
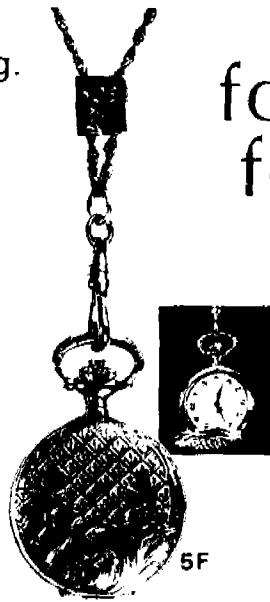
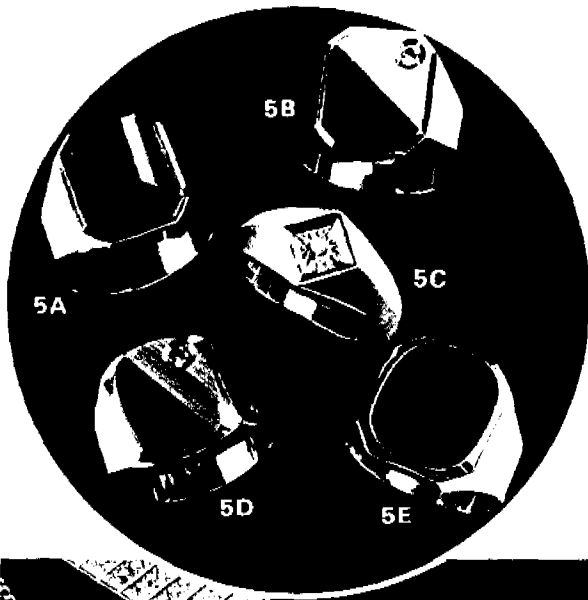

5A. 14K Y.G. Gents Tigereye Ring \$244.95
 5B. 14K Y.G. Gents Black Onyx and .03 ct. Diamond Ring \$229.95
 5C. 10K Y.G. Gents Diamond Ring \$189.95
 5D. 14K Yellow Gold Gents Jade and .03 ct. Diamond Ring \$299.95
 5E. 14K Y.G. Gents Onyx Ring \$199.95
 5F. Yellow Pendant Watch. Slide chain . . . \$130.00
 5G. New exclusive Mother's Watch. Holds up to 9 stones \$49.95
 5H. 19K Y.G. Mother's Ring which holds as many as 7 stones \$133.50
 Stones each \$9.60

5J. Yellow Skeleton Pendant Watch \$77.50
 5K. All Steel Gents Watch with calendar and sweep second hand \$39.95
 5L. "Stagecoach" Pocket Watch. Horses on dial, Yellow or White \$77.50
 5M. Yellow Pocket Watch. Gold filled knife and chain \$155.00
 5N. Ladies' Bracelet Watch. Yellow. Champagne dial or white/blue dial \$49.95
 5P. Ladies' Watch with Attached Bracelet. Yellow. Champagne dial or white/blue dial \$57.50
 5R. Ladies' Watch. Mesh Bracelet \$67.50

5S. Ladies' Watch with 6 Diamonds. Yellow or White \$99.95
 5T. 24" Y.G.F. Serpentine Chain \$14.95
 5V. 18" Y.G. "C" Chain \$16.95
 5W. 16" Y.G.F. Woven Rope Chain \$36.95
 5X. 18" Y.G.F. Cobra Chain \$44.95
 7" Y.G.F. Cobra Bracelet \$20.95
 5Y. 18" Y.G.F. Serpentine Chain \$30.95
 5Z. 18" Y.G.F. Woven Bracelet \$19.95
 5AA. Y.G.F. Stick Pin Set with Diamond \$20.95
 5BB. Y.G.F. Bar Pin \$22.95
 5CC. Y.G.F. Chatelaine Pin with Heart and Butterfly \$17.95

chains and matching sets from...

Priscilla®

Delightful Chains and Sets for M' Lady's Pleasure

6A. 14K Yellow Gold with Beautifully Lustrous Opal.
6AR 10K Ring \$99.95
6AP 14K Pendant \$99.95
6AE 14K Earrings \$119.95

6B. 14K Rose Gold with Sparkling Diamond.
6BR 10K Ring \$164.95
6BP 14K Pendant \$169.95
6BE 14K Earrings \$129.95

6C. 14K Yellow Gold with Beautifully Lustrous Opal.
6CR 14K Ring \$169.95
6CP 14K Pendant \$139.95
6CE 14K Earrings \$169.95

6D. 14K Yellow Gold with Marquise Ruby and Diamond.
6DR 14K Ring \$229.95
6DP 14K Pendant \$189.95
6DE 14K Earrings \$239.95

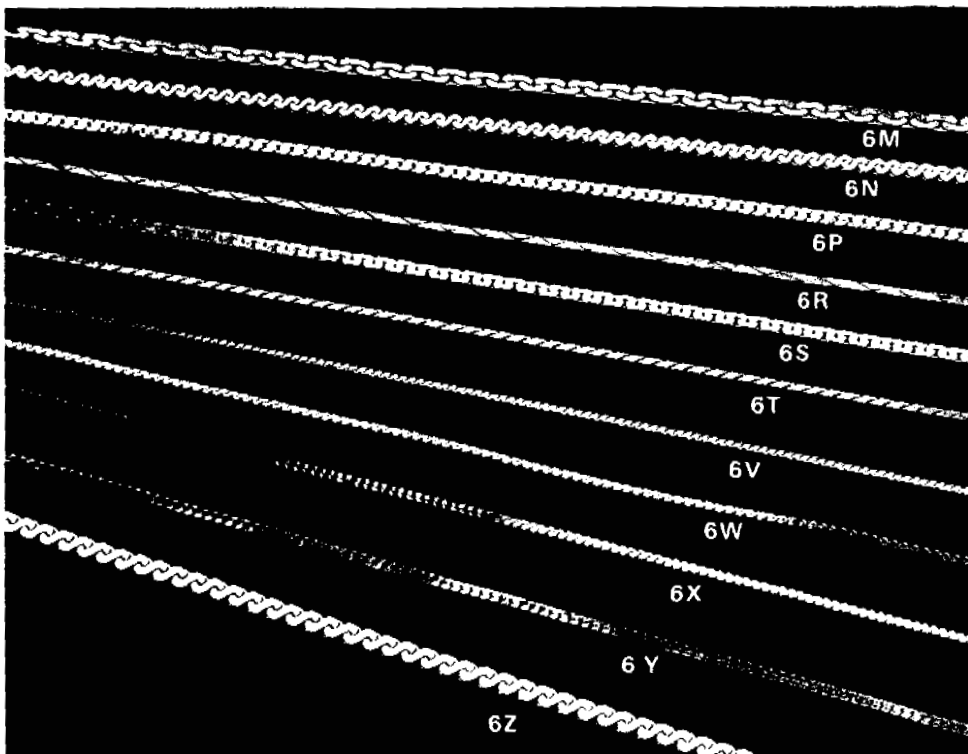
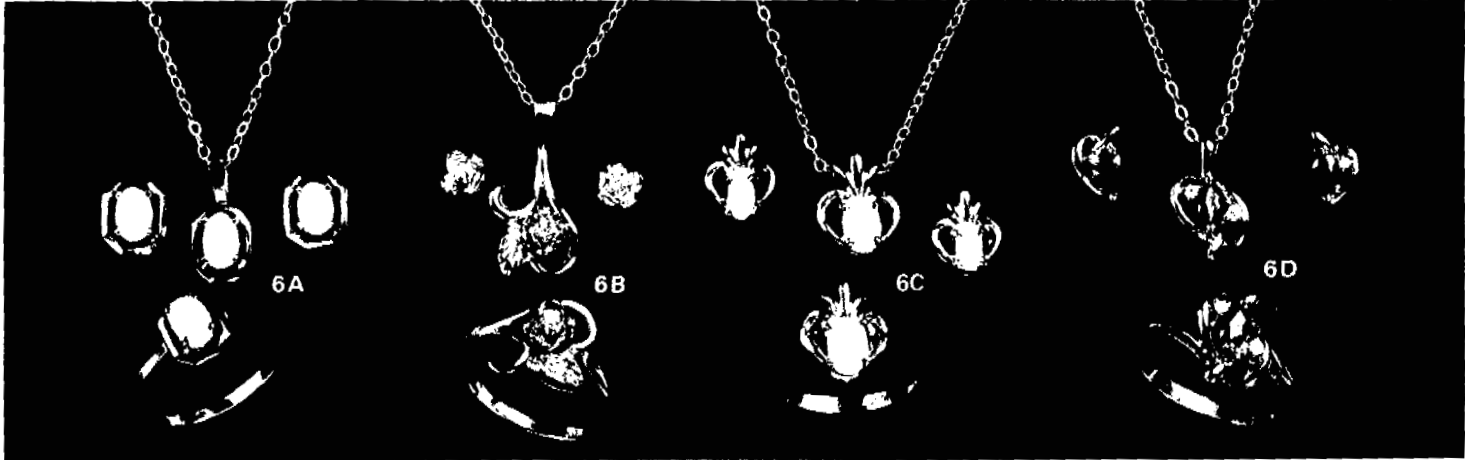

6E. 14 Yellow Gold Lustrous Cultured Pearl and Diamond Necklace \$189.95
6F. 14K Y.G. Opal Pendant \$89.95
6G. 14K Y.G. Ruby and Diamond Pendant... \$169.95
6H. 14K Y.G. Diamond Pendant \$129.95
6J. 14K Y.G. Opal Pendant \$109.95
6K. 14K Y.G. Garnet and Diamond Necklace... \$199.95
6L. 14K Y.G. 15" Necklace
6LE. With Genuine Emerald \$99.95
6LR. With Genuine Ruby \$99.95
6LS. With Genuine Sapphire \$99.95
6M. 14K German 20" "C" Chain \$279.95
6N. 14K Italian 20" Serpentine Chain .. \$219.95
6P. 14K Italian 20" Herringbone Chain .. \$264.95
6R. 14K Italian 18" Cobra Chain \$169.95
6S. 14K Italian 15" "C" Chain \$154.95
6SC. 14K Italian 18" "C" Chain \$184.95
6SB. 14K Italian 7" "C" Bracelet \$79.95
6T. 14K Italian 15" Cobra Chain \$79.95
6V. 14K Italian 15" Serpentine Chain .. \$49.95
6W. 14K Italian 16" Serpentine Chain .. \$69.95
6WC. 18" Serpentine Chain \$74.95
6WN. 24" Serpentine Chain \$99.95
6X. 14K Italian 30" Serpentine Chain .. \$119.95
6XB. 14K Italian 7" Serpentine Bracelet .. \$34.95
6Y. 14K Italian 16" Herringbone Chain .. \$79.95
6YB. 14K Italian 7" Herringbone Bracelet .. \$42.95
6Z. 14K Italian 8" Serpentine Bracelet ... \$129.95

the splendor and the colors of love

*Priscilla®
Jewelry*

Promises of Love . . .

In 10K gold settings

- 7A. Woven rope design with center diamond . . . \$89.95
- 7B. Smooth lines accentuate diamond . . . \$99.95
- 7C. Interlocking hearts with diamond . . . \$84.95
- 7D. Stylized heart with diamond . . . \$99.95
- 7E. A lover's knot with two diamonds . . . \$104.95
- 7F. A soft swirl with a gleaming diamond . . . \$99.95
- 7G. The lover's ribbon with diamond . . . \$99.95
- 7H. A sparkling diamond for her heart . . . \$99.95
- 7J. Tied band with two diamonds . . . \$129.95

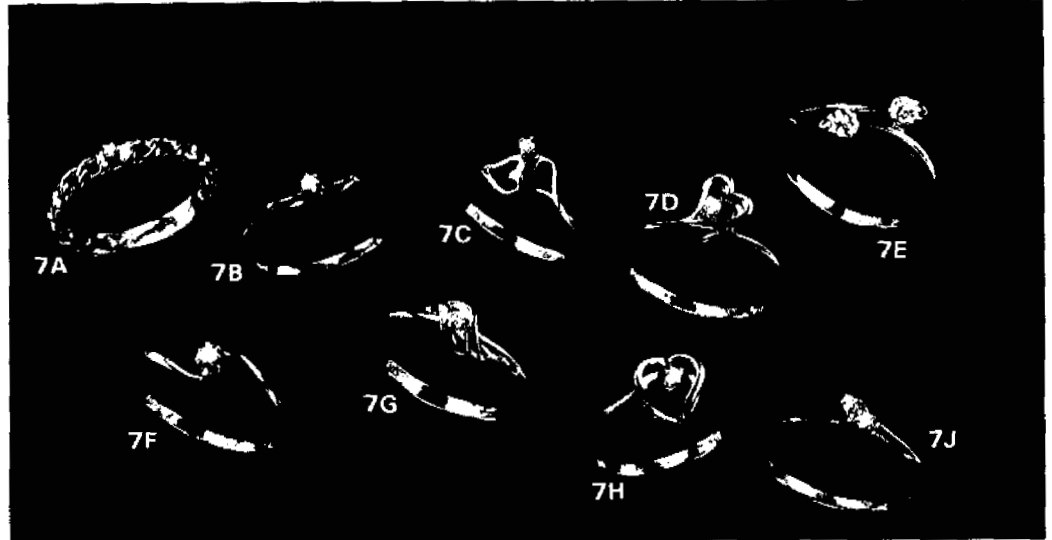

The Gift of Love

in 10K gold settings

- 7K. Lattice work surrounds center opal . . . \$109.95
- 7L. A fiery opal to warm her heart . . . \$99.95
- 7M. Genuine opal with two lovers' hearts . . . \$89.95
- 7N. Antique style ring with large center onyx and sparkling diamond . . . \$119.95
- 7P. A lovers' duo with two cultured pearls . . . \$104.95
- 7R. Filigree ring with genuine jade . . . \$129.95
- 7S. Alluring cat's eye quartz ring . . . \$74.95
- 7T. Victorian style cameo . . . \$89.95
- 7U. Swirl design enhances genuine opal . . . \$119.95
- 7V. A genuine garnet to warm her heart . . . \$99.95

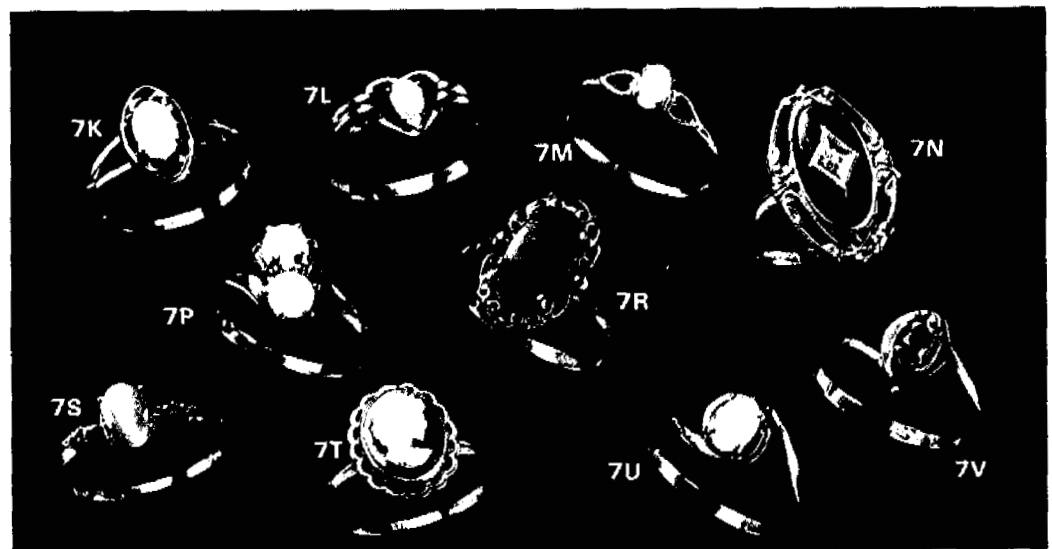

That Very Special Sparkle

- 7W. 10K butterfly of love with a sparkling diamond and two rubies . . . \$169.95
- 7X. 10K filigree setting with opal . . . \$159.95
- 7Y. 10K yellow gold setting is accentuated by two gleaming diamonds and center ruby . . . \$159.95
- 7Z. Large, center emerald is accentuated by two sparkling diamonds and a 14K gold setting . . . \$299.95
- 7AA. Genuine ruby and diamond . . . \$299.95
- 7BB. Large fire opal is highlighted by two gleaming diamonds in a 14K gold setting . . . \$199.95
- 7CC. Azure aquamarine with two diamonds in a 10K gold setting . . . \$179.95
- 7DD. Two emeralds in 10K gold setting . . . \$119.95
- 7EE. Crimson rubies in a butterfly. 10K . . . \$64.95
- 7FF. This heart shaped garnet with two side diamonds is sure to warm her heart. 10K gold . . . \$129.95
- 7GG. Sapphire with two diamonds. 10K . . . \$189.95
- 7HH. Stylized center sapphire is highlighted by two diamonds. 10K gold setting . . . \$154.95

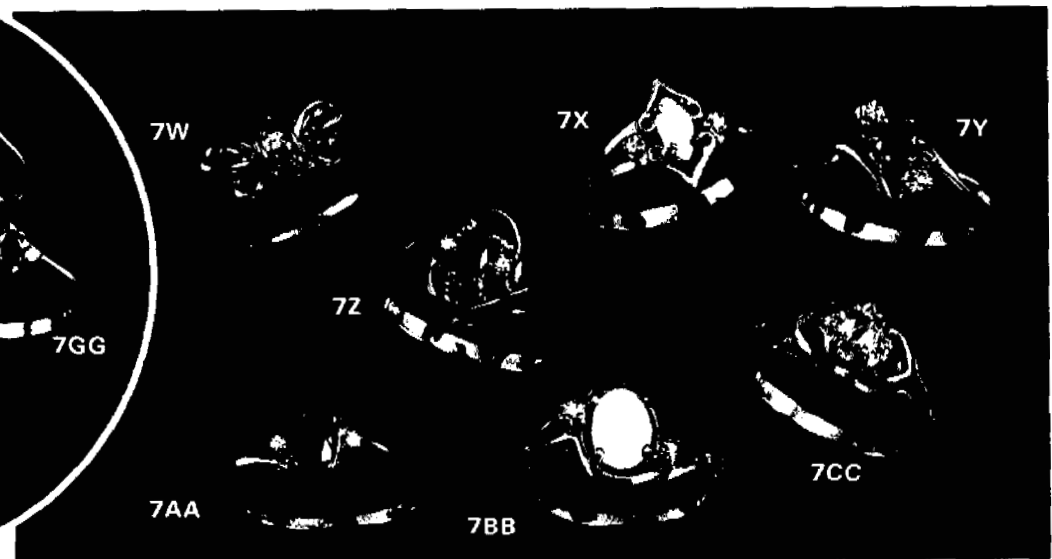
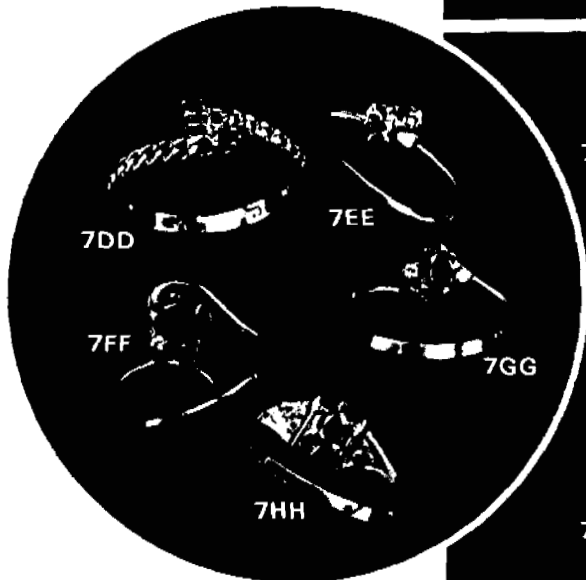

very special gifts of...

Priscilla®

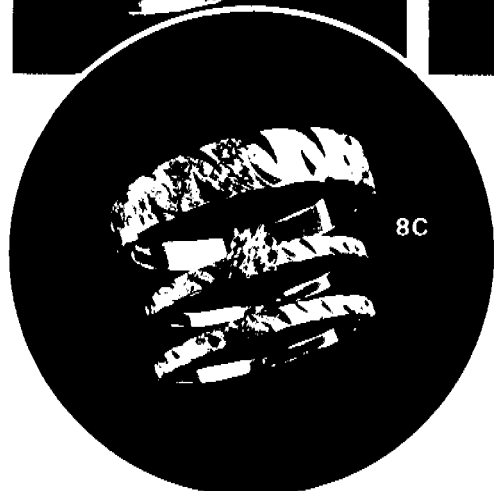
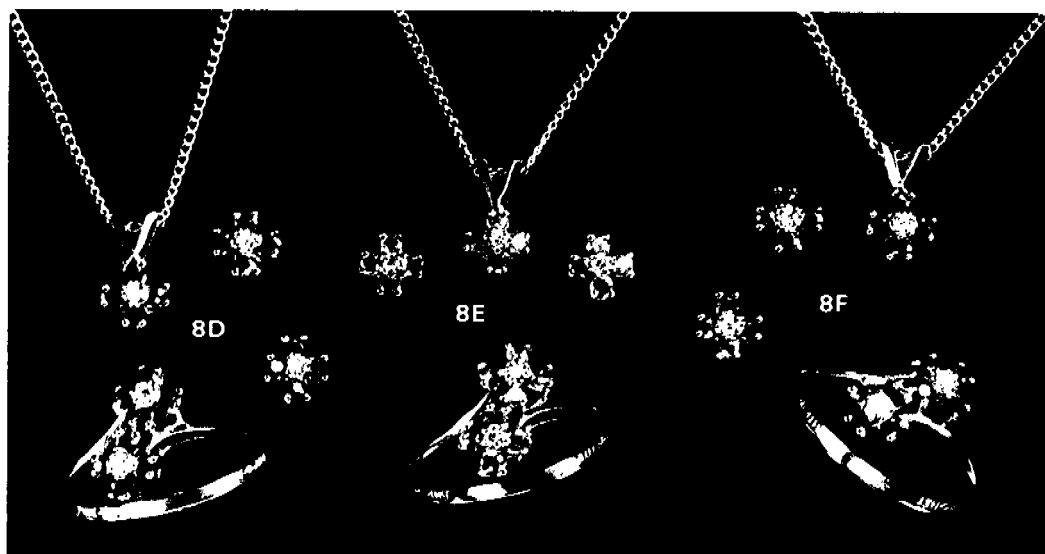
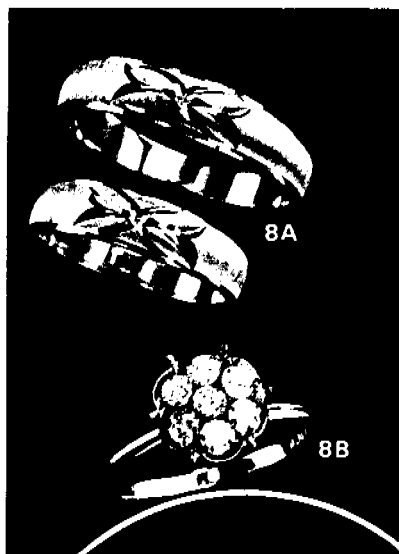

Precious Gems to Capture Her Heart and Her Fancy!

8A. 10K Yellow Gold His/Hers Wedding Band Set.
1 diamond each \$106.50
8B. 14K White Gold 7-Diamond Ring.
1/7 carat Total Weight \$280.00
1/5 carat Total Weight \$317.50
1/4 carat Total Weight \$367.50
8C. 10K Yellow Gold 3-Piece Set.
Eng. \$103.50 . . . Wed. \$62.50 Grooms . . \$106.50
8D. 14K White Gold:
Ring: 2 diamonds/8 rubies \$275.00
Pendant: 1 diamond/4 rubies \$125.00
Earrings: 2 diamonds/8 rubies \$165.00

8E. 14K Yellow Gold:
Ring: 2 diamonds/8 emeralds \$275.00
Pendant: 1 diamond/4 sapphires \$125.00
Earrings: 2 diamonds/8 emeralds \$165.00
8F. 14K White Gold:
Ring: 2 diamonds/8 sapphires \$275.00
Pendant: 1 diamond/4 sapphires \$125.00
Earrings: 2 diamonds/8 sapphires \$165.00
8G. 16" 14K Yellow Gold "C" Chain/Opal Neck-
lace \$199.95
8H. 7" 14K Yellow Gold "C" Chain/Opal Bracelet.
. \$189.95
8J. 15" 14K Yellow Gold Serpentine Chain/Ruby
Butterfly Necklace \$129.95
8K. 7" 14K Yellow Gold Serpentine Chain/Ruby
Butterfly Bracelet \$129.95
8L. 14K Yellow Gold Tapered Baguette Shaped Peri-
dot: Diamond Necklace \$219.95
8M. 14K Yellow Gold Trapezoid Shaped Peridot
Butterfly: Diamond Necklace \$259.95
8N. 14K Yellow Gold Triangle Shaped Aquamarine:
Diamond Necklace \$239.95
8P. 14K Yellow Gold Heart Shaped Almandine Gar-
net: Diamond Necklace \$189.95
8R. 14K Yellow Gold Straight Baguette Shaped
Amethyst: Diamond Necklace \$219.95

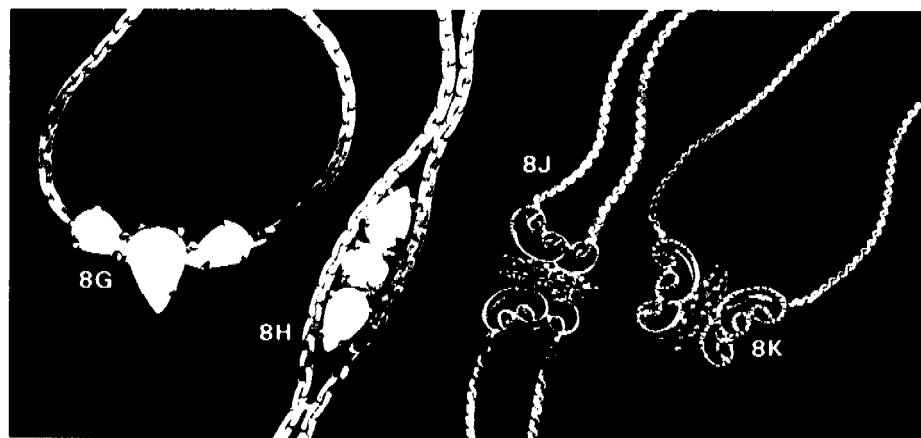

TIMEX the gift of time

TX1. (90101) Mini-Alarm. Black or beige molded case. 1 1/2" wide and 1" deep. Luminous hands, hour markers. Easy-set alarm. Includes matching travel case \$21.95

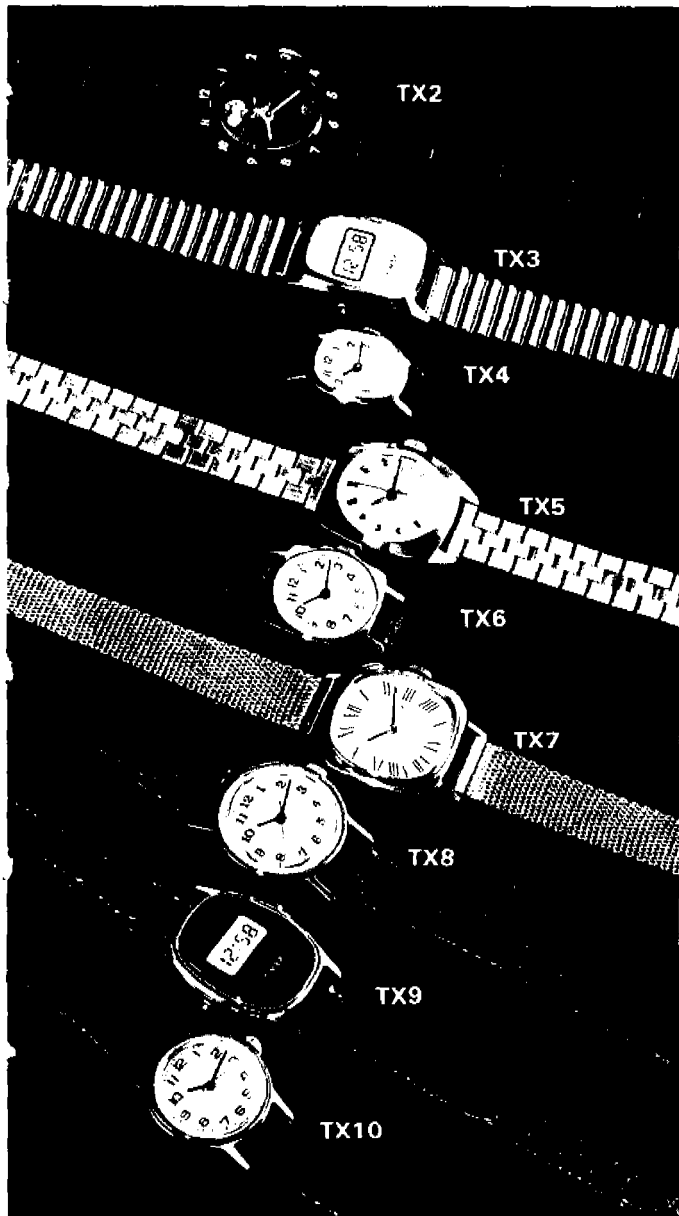
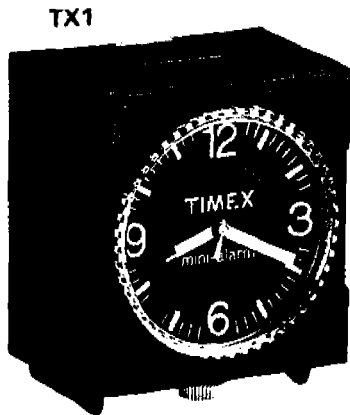

TX2. (84111) Snoopy & the Red Baron. Black chrome plated bezel, full numerals. Snoopy dial with "flying" Red Baron sweep. Black sports strap \$19.95
TX3. (63467) Nite-Lite Marathon LCD. Goldtone bezel, white mask, sliding clasp band. Constant digital readout, hours, minutes, seconds and date \$42.95
TX4. (10111) Cavatina. Fashionable oval, chrome plated bezel. Black strap. Unbreakable mainspring, stainless steel back \$15.95
TX5. (16117) Sportster. Calendar, adjustable expansion band, sweep second hand. Water, dust resistant. Unbreakable mainspring \$21.95
TX6. (14622) Cavatina. Cushion goldtone bezel. Water, dust resistant. Brown strap. Unbreakable mainspring. Stainless steel back \$19.95
TX7. (15237) Cavatina. Square goldtone bezel, brushed dial, mesh band. Unbreakable mainspring. Stainless steel band \$25.95
TX8. (12961) Petite. Round, chrome plated bezel. Unbreakable mainspring. Full sweep second hand. Black strap \$14.95
TX9. (62961) Nite-Lite Marathon LCD. Chrome plated bezel, blue mask, blue strap \$34.95
TX10. (41322) Women's Electric. Chrome plated bezel, full numerals. White dial, black strap. Sweep second hand \$34.95

TX11. (47617) Men's Electric. Shaped, goldtone bezel, champagne brushed dial, adjustable expansion band. Water and dust resistant \$35.95
TX12. (28661) Marlin. Day, date. Cushion shaped goldtone bezel. Stainless steel back. Water, dust resistant. Sweep second hand. Brown strap \$23.95
TX13. (25311) Mercury. Calendar. Chrome plated bezel, black strap, sweep second hand. Unbreakable mainspring. Stainless steel back \$17.95
TX14. (58367) Quartz. Accurate Quartz crystal movement. Day, date, chrome plated bezel, black sports dial. Water, dust resistant. Etapsed time ring. Metal band \$52.95
TX15. (68667) 6-Digit Nite-Lite Marathon LCD. Constant digital readout, hours, minutes, seconds, date. Reads in total darkness. Dust, water resistant. Goldtone bezel, black mask \$52.95
TX16. (37711) Automatic. Self-wind. Water, dust resistant. Unbreakable mainspring \$26.95
TX17. (69867) Nite-Lite Marathon LCD. Nite-Lite chronograph. Octagonal, goldtone bezel, champagne mask, link sliding clasp band \$57.95
TX18. (29221) Men's 17 Jewel. Goldtone bezel. Blue dial, black strap, stainless back \$34.95
TX19. (65761) Nite-Lite Marathon LCD. Constant digital readout. Hours, minutes, seconds, date, month. Dust, water resistant \$34.95

very special gifts that keep on giving...

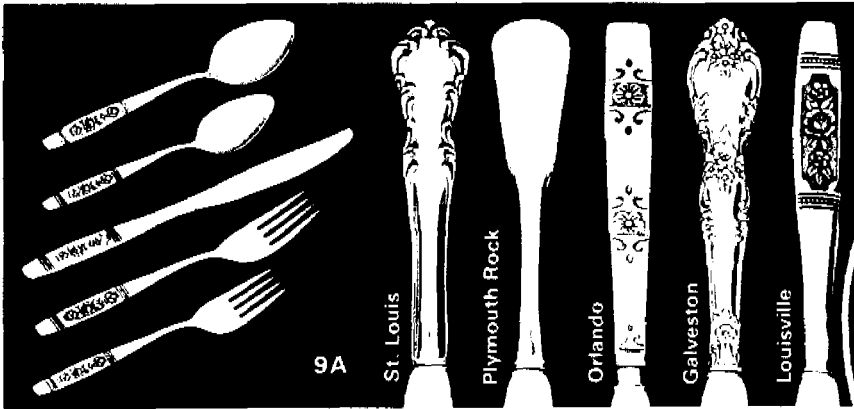

9A

St. Louis

Plymouth Rock

Orlando

Galveston

Louisville



9B

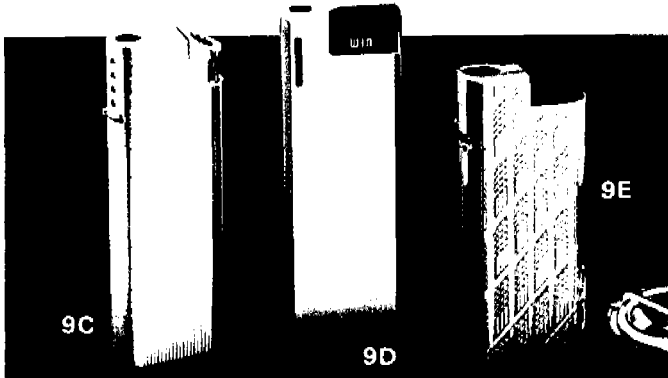

9C

9D

9E

Some Special Gift Giving Ideas... for him, and for her



9F

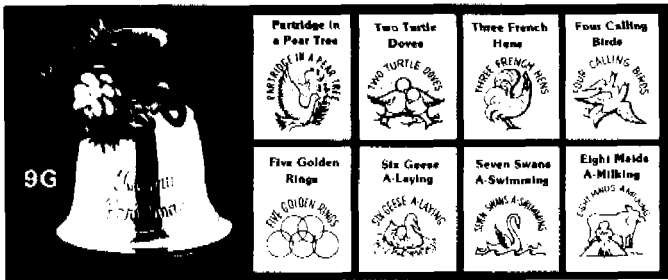

9G

<p>Partridge in a Pear Tree</p>	<p>Two Turtle Doves</p>	<p>Three French Hens</p>	<p>Four Calling Birds</p>
<p>Five Golden Rings</p>	<p>Six Geese A-Laying</p>	<p>Seven Swans A-Swimming</p>	<p>Eight Maids A-Milking</p>

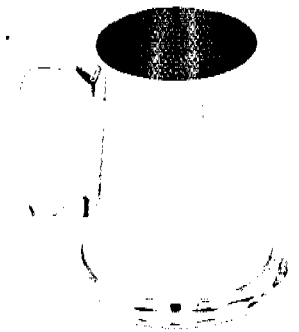

9M. Pewter Tankard. The gleaming pewter finish highlights this glass bottom mug. Comes gift boxed for easier gift giving. Now Only \$15.95 Regularly \$24.95



9H

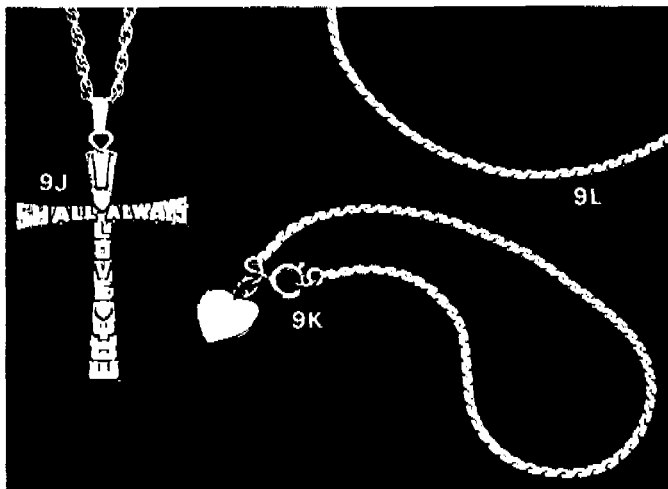

9J

9L

9K

9A. "Profile" Flatware by Oneida. The finest quality stainless flatware, in your choice of five lovely patterns. Each forty piece set contains eight each: tea spoons; soup spoons; salad forks; dinner forks; dinner knives. Your Choice \$49.95 . . . Regularly \$70.00
 9B. Silverplated Coffee Service by Oneida. Always stylish! Each set includes coffee server, sugar bowl, creamer, serving tray. Now Only \$59.99 . . . Regularly \$87.50
 9C. Quartz Butane Lighter. Silvertone lighter in 2 3/4" designed finished case. . . . \$19.95
 9D. Quiet Quartz Butane Lighter. Slender 2 3/4" case in yellow goldtone . . . \$24.95
 9E. Electronic Butane Lighter. Diamond-cut pattern on goldtone case. 2 3/4" . . . \$16.95

9F. Money Clip with Engraving Plate. The perfect gift idea! Yellow gold plated. \$10.00
 9G. Collector's Set of Silverplated Christmas Balls. Featuring the eighth in a series of the classic Twelve Days of Christmas. 3" bells are gift boxed. Your Choice \$9.95
 9H. Monte Carlo Party Set with Server. Stainless party set will not tarnish. Arrives gift boxed. Great gift giving idea! Now Only \$7.95 . . . Regularly \$14.00
 9J. Rhodium Cross. Embossed with, "I Shall Always Love You". 24" chain . . . \$12.50
 9K. Heart Locket Bracelet. Yellow gold plated "S" link chain, heart charm . . . \$8.50
 9L. "S" Link Neck Chain. Yellow gold plated chain is 18" long. Matches 9K . . . \$12.50

treasure chests and treasures... to have and to give

11A. Solid Wood Jewelry Box. Removable fully lined tray folds to become a travel case. Inside mirror, necklace hooks. 12½x8x6" **\$44.95**

11B. Solid Wood Jewelry Box. Revolving top. Latticed doors. Lift-out ring and earring compartment. Rotating neck chain hanger. Plenty of space and a place for everything. 18¼x12½x6¾" **\$99.95**

11C. Solid Wood Jewelry Box. Rotating earring section. Mirrored necklace compartment with rotating hangers. Secret hidden drawer in back. 19½" high, 14" wide, 7½" deep **\$119.95**

11D. Solid Wood Oriental Jewelry Box. An Oriental treasure chest in handsome cherrywood finish with accents and fittings of polished brass. Lock and key. 10x7x6" **\$69.95**

11E. Men's Solid Wood Dresser Valet. Cain-inlaid lift-up top, three top wells, lined drawers. Keeps jewelry, glasses, keys, coins neatly organized and instantly accessible. 12x6½x4¼" **\$19.95**

11F. Solid Wood Jewelry Box. Two roll-out drawers for rings, four drawers for other jewelry. 9¼" high, 8¼" wide, 5¼" deep **\$19.95**

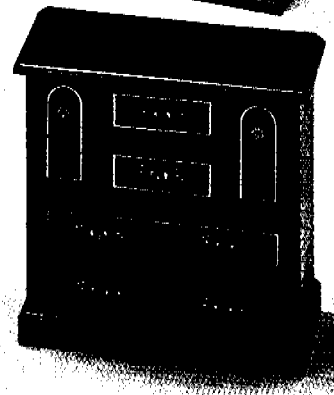
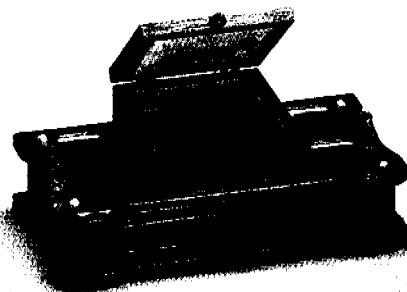
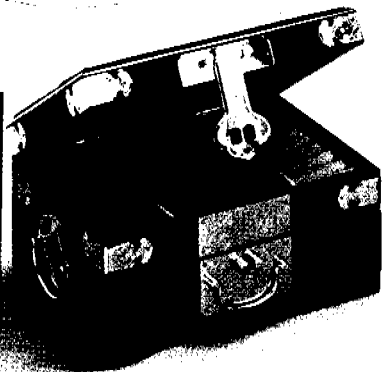
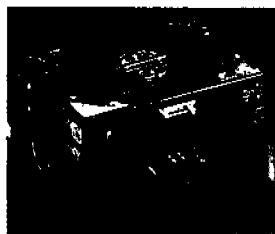
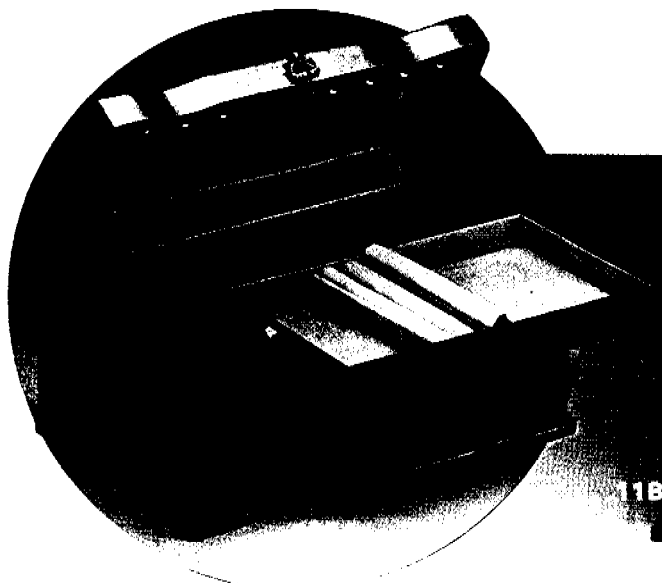

11G. Hand Painted "Goldimari" Porcelain Ginger Jar. Panel design. Rosewood base. With base, 5¼" diameter, 7½" high **\$39.95**
11H. Hand Painted "Satswana" Temple Jar. 7½" high; 4" diameter **\$37.95**
11J. Hand Painted 6¾" High Porcelain Bisque Robin. Wooden base **\$19.95**

11K. Hand Painted 6¼" High Porcelain Bisque Rabbit. Wooden base **\$19.95**
11L. Hand Painted 6¼" High Porcelain Bisque Swan. Wooden base **\$19.95**
11M. Hand Painted 6¼" High Porcelain Bisque Raccoon. Wooden base **\$19.95**

Bulova® for him

Time to be remembered

Quartz Accuracy

12A



17Jewel

12B



Silver Linen Dial

12C

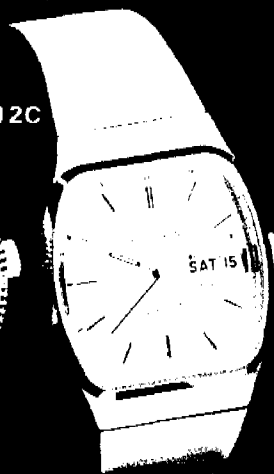

Easy-to-Read

12D



Electronic Convenience

12E



The Classic Caravelle

12F



Water Resistant

12G

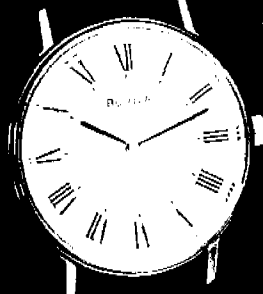

Time Zone Feature

12H

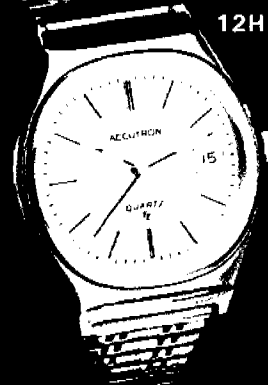

Quartz Precision

12M



For Dress or Sport

12J



Caravelle Calendar

12K

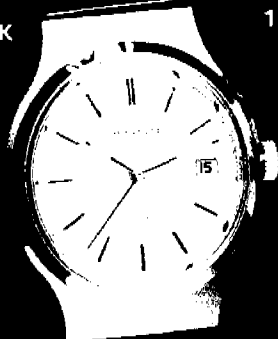

Classic Styling

12L

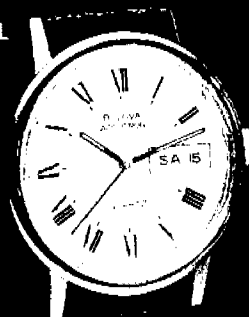

Precision timekeeping . . .
Styled to Please

Bulova® for her

The gift of time



13A

Satin Finish



Computerized Time

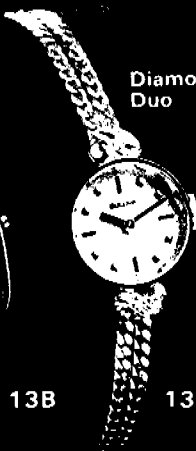

Diamond Duo

13B

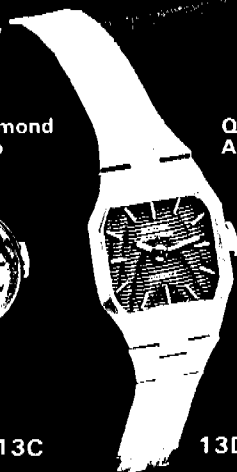

Quartz Accutron

13C

13D

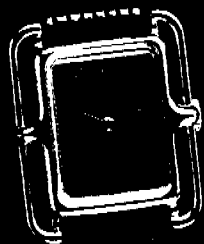

The Regal Roman

13E



17 Jewels

13F



13G

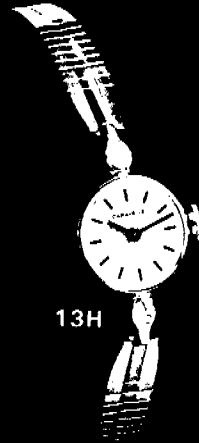

13H

The Perfect Circlet



Ebony & Goldtone

13J

Caravelle



13K



A Fashion Favorite

13L

- 12A. Bulova Quartz Day and Date.** Water resistant, with sweep second hand and adjustable bracelet \$150.00
- 12B. Bulova Day & Date Calendar.** 17 jewel movement. Water resistant with adjustable bracelet \$110.00
- 12C. Accutron Quartz.** Water resistant. Accuset and Dura Crystal . . . \$275.00
- 12D. Bulova Quartz.** Sweep second hand on full numeral dial. Water resistant. Stainless steel back \$79.95
- 12E. Caravelle from Bulova.** Electronic convenience with superb styling. With adjustable bracelet \$79.95
- 12F. Caravelle from Bulova.** Goldtone strap model with sweep second hand. Water resistant \$44.95
- 12G. Bulova.** Elegant simplicity in goldtone. 17 jewel movement. Water resistant \$99.95
- 12H. Bulova Accutron Quartz.** Time zone feature lets you adjust hours without disrupting minutes-seconds. Water resistant. With Accuset. Stainless steel adjustable band \$185.00
- 12J. Bulova Oceanographer.** Depth tested to 333 feet, with magnified date window, set-o-matic and 17 jewel movement \$140.00
- 12K. Bulova Caravelle Calendar.** Water resistant with sweep second hand. Stainless BulovaFlex bracelet \$44.95
- 12L. Bulova Accutron Quartz.** Water resistant. With Accuset, scratch resistant Dura Crystal. Genuine black lizard strap \$160.00
- 12M. Bulova Quartz.** Water resistant. Adjustable stainless band \$125.00
- 13A. Accutron Quartz Calendar.** With black Roman numerals and gilt applied sticks on silver dial. Dura Crystal \$200.00
- 13B. Quartz LCD Digital.** Constant hour, minute display. Seconds, day, date on command. With Perma Lite. Water resistant \$155.00
- 13C. Styled Dress Watch.** With two diamonds and double strand mesh chain bracelet. 17 jewel movement \$150.00
- 13D. Accutron Quartz.** Silvertone with matching link bracelet and blue dial. Raised silver markers \$150.00
- 13E. Regal Roman.** 17 jewel movement. Genuine black lizard strap . . . \$115.00
- 13F. Quartz LCD Digital.** Constant hour and minute readout. Seconds, day, date on command. Water resistant. With Dura Crystal, Perma-Lite \$99.95
- 13G. Bulova.** Silvertone with attached mesh bracelet. 17 jewels . . . \$135.00
- 13H. Caravelle from Bulova.** With layout bracelet, safety chain \$54.95
- 13J. Caravelle from Bulova.** Goldtone oval frames Roman numeral dial . \$64.95
- 13K. Caravelle from Bulova.** Black Brequette numerals on contrasting silvered dial \$79.95
- 13L. Accutron Quartz.** With calendar window, sweep second hand. Water resistant, Dura-Crystal \$185.00

to show that you care

Anson

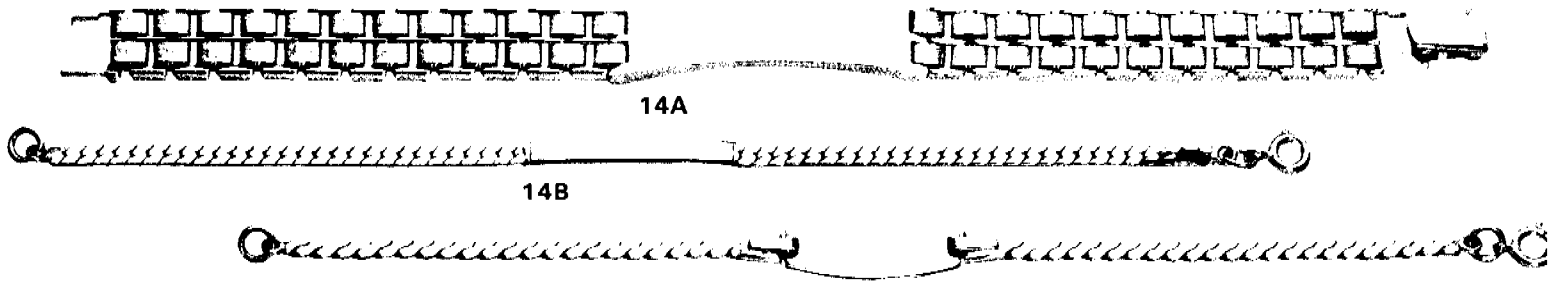

The Engraveables . . .
Bracelets 'n Things for Men and Women

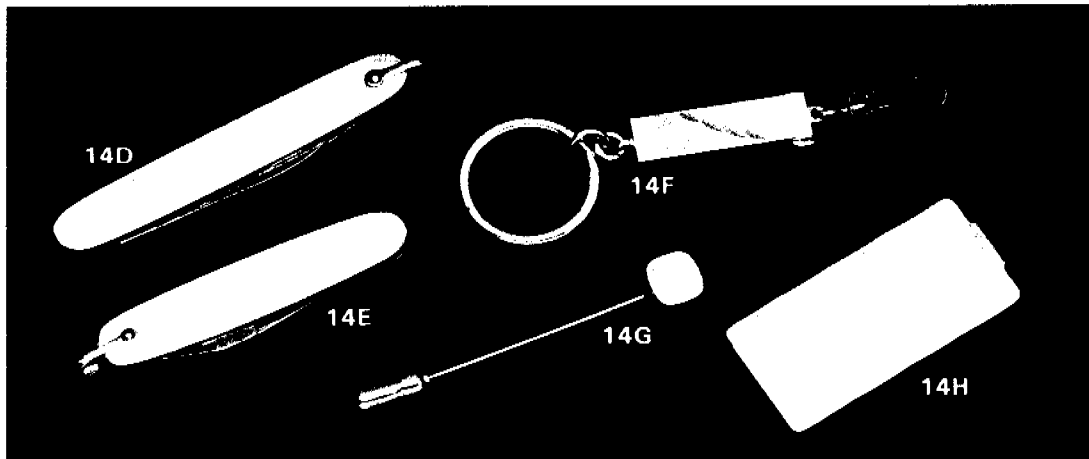

- 14A. Men's Gold Plated Engraveable Identity Bracelet \$16.50
- 14B. Ladies' Gold Filled Engraveable Identity Bracelet \$22.50
- 14C. Ladies' Gold Filled Engraveable Identity Bracelet \$25.00
- 14D. Gold Filled Engraveable Knife with 2 Blades \$32.50
- 14E. Sterling Engraveable Knife with Blade and Opener \$32.50
- 14F. Sterling Engraveable Key Protector; Ring and Clip \$18.50
- 14G. Gold Filled Engraveable Stick Pin \$12.50
- 14H. Silver Overlay Engraveable Money Clip \$22.50

Unisex Gift
Items . . .
for Him and for Her!

- 14J. Ladies' Gold Filled 24" Lariat Chain with Engraveable Slide \$32.50
- 14K. Sterling St. Christopher Medal with Engraveable Back. 24" stainless steel chain \$35.00
- 14L. Men's Gold Filled 18" Twisted Rope Neck Chain \$35.00
- 14M. Men's Gold Filled 18" Herring-bone Design Neck Chain \$38.50
- 14N. Men's Gold Filled 18" Four-Sided Cable Neck Chain \$45.00

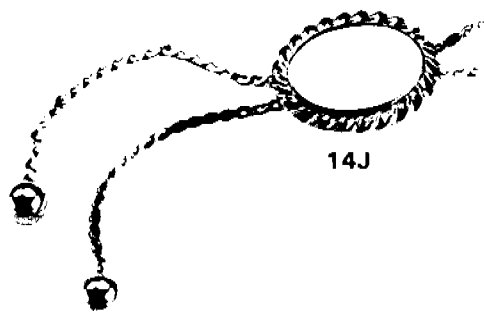

Some jewelry enlarged to show details. Prices subject to change without notice.

hearts, butterflies and other gifts of love...

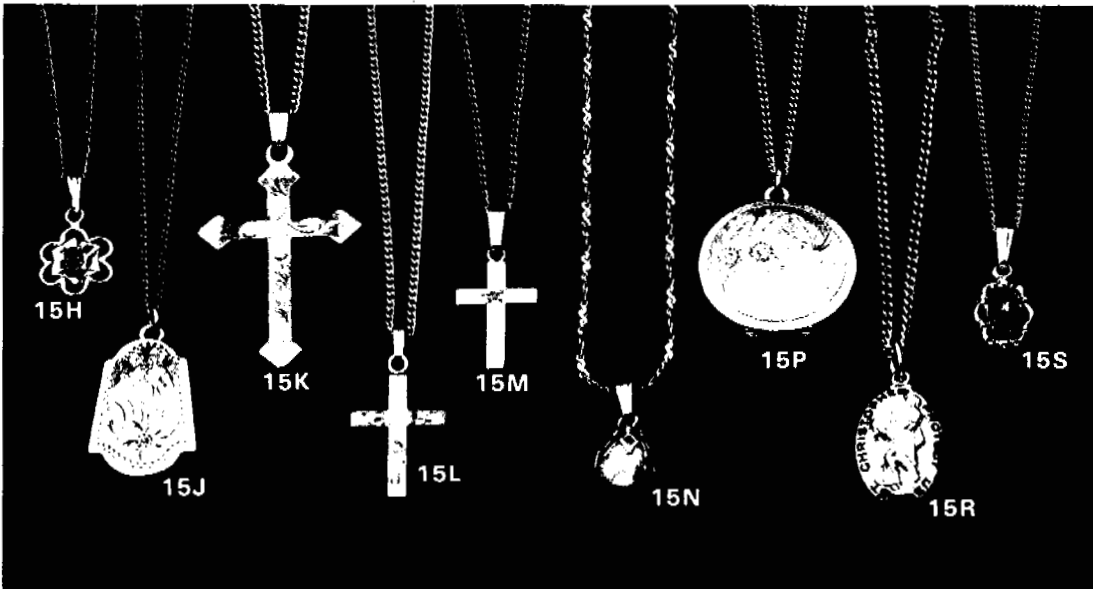

Classic Fashions

- 15A. Sterling Sapphire Pendant; Matching Earrings; 14K posts \$59.95
- 15B. Y.G.F. Cultured Pearl Pendant; Matching Earrings; 14K posts . \$34.95
- 15C. Y.G. Filled Ruby Pendant; Matching Earrings; 14K posts \$64.95
- 15D. Sterling Spinel Heart-Shaped Pendant \$19.95
- 15E. Y.G. Filled Opal Pendant \$20.95
- 15F. Sterling Diamond Double-Heart Pendant \$36.95
- 15G. Y.G. Filled Lariat Serpentine Chain; Earrings; 14K posts \$44.95
- 15H. Y.G. Filled Ruby Pendant \$28.95
- 15J. Y.G. Filled 3-Color Locket \$40.95
- 15K. Y.G. Filled 3-Color Cross \$44.95
- 15L. Y.G. Filled 3-Color Cross \$38.95
- 15M. Sterling Diamond Cross \$32.95
- 15N. Y.G. Filled Cultured Pearl Pendant; Serpentine Chain \$36.95
- 15P. Y.G. Filled 3-Color Locket \$49.95
- 15R. Sterling Two-Tone St. Christopher Medal \$22.95
- 15S. Sterling Hope Star Pendant \$44.95

Delicately Feminine Pierced Earrings

- 15T. 14K Yellow Gold. Cultured Pearls \$38.95
- 15V. Yellow Gold Filled Serpentine Chain Hoops; 14K posts \$20.95
- 15W. Sterling Simulated blue Star; 14K posts . \$16.95
- 15X. Yellow Gold Filled Opal Butterflies; 14K posts \$22.95
- 15Y. Yellow Gold Filled Fancy Hoops; 14K posts \$17.95
- 15Z. 14K Yellow Gold Double Hearts \$30.95
- 15AA. Yellow Gold Filled Ruby Crosses; 14K posts \$24.95
- 15BB. 14K Yellow Gold Ruby Buttercups . . . \$38.95
- 15CC. Yellow Gold Filled Fancy Hoops; 14K posts \$26.95
- 15DD. 14K Yellow Gold Opal Ovals \$38.95

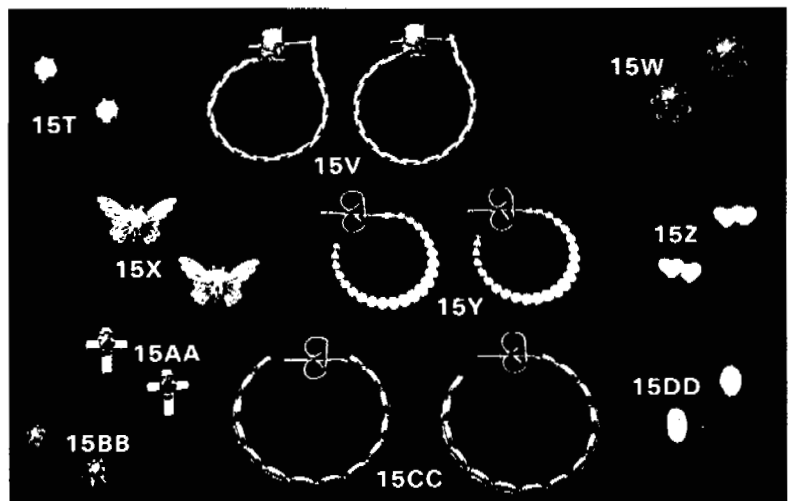

SPECIAL VALUE!



16C

**ONE CARAT
BRILLIANT CUT
DIAMOND!**

16C. One-Carat Brilliant Round Diamond. Start a family tradition by giving this sparkling gem to the lady in your life. \$3750.00

**FREE
14K GOLD
MOUNTING!**

Special Bonus! Beautiful 14K white or yellow gold mounting, as shown, Free with purchase of the above diamond.

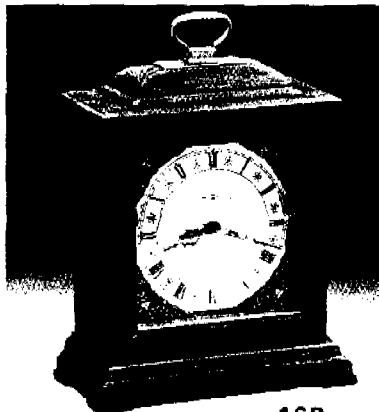

16B

16B. Howard Miller Solid Oak "The Canterbury" Clock. Glass dial crystal, Westminster (battery) chimes on the hour; strikes on the half-hour. 12 1/2" x 9 1/4" x 4 3/8" \$149.95

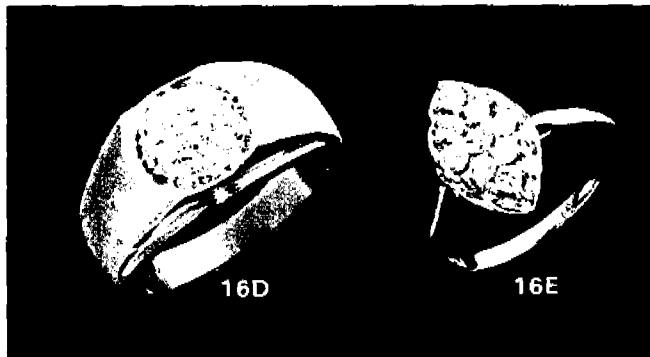

16D

16D. 10K Yellow Gold Ring. 10 diamonds; 1/4-carat Total Weight \$427.50

16E

16E. 14K White Gold Ring. 9-diamonds; 1/2-carat Total Weight \$592.50

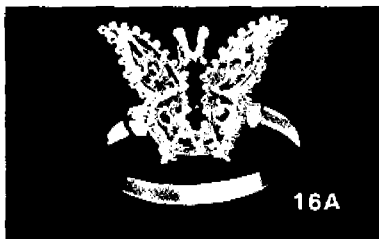

16A

16A. 10K Yellow Gold Emerald Butterfly Ring \$89.95



16F

16F. 14K Heart-Shaped Ruby Pendant . . \$79.95



16G

16G. Heart-Shaped Sterling - Diamond \$16.95

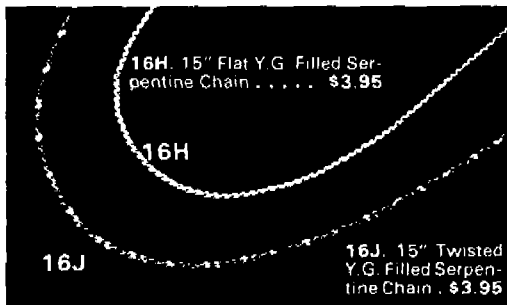

16H. 15" Flat Y.G. Filled Serpentine Chain \$3.95

16H

16J

16J. 15" Twisted Y.G. Filled Serpentine Chain . \$3.95

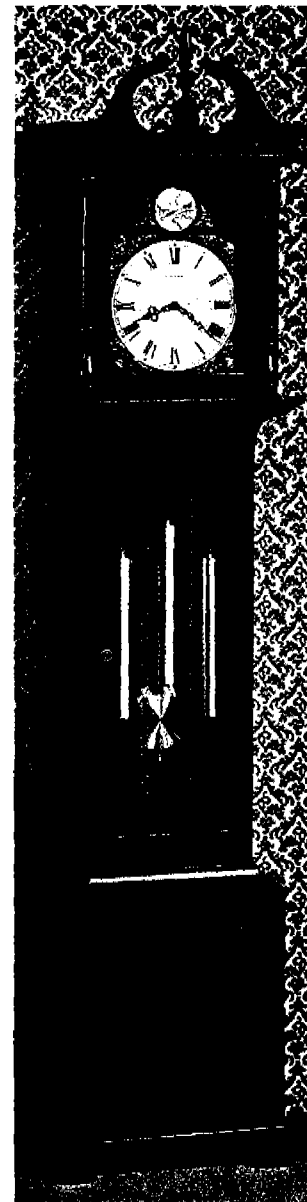

16K. Howard Miller Cherrywood "The Esquire" Grandfather Clock. Westminster chimes, H 75 1/2" x W 16 1/2" x D 10 1/2" \$525.00

**MCCONKEY JEWELRY
& GIFT SHOP
6458 MAIN STREET
CASS CITY, MICHIGAN 48726
872-3025**

SUPPLEMENT TO THE CASS CITY CHRONICLE

125-1-A/5000