

CASS CITY CHRONICLE

VOLUME 82, NUMBER 31

CASS CITY, MICHIGAN - WEDNESDAY, NOVEMBER 9, 1988

TWENTY-FIVE CENTS

16 PAGES PLUS 2 SUPPLEMENTS



TRAFFIC CONGESTION AT the west end of Cass City, including the intersection of Doerr Road and Main Street (above), has village officials concerned. State doubts it's necessary

Request stoplight at Doerr Road-Main Street corner

Traffic congestion near Doerr Road and Main Street in Cass City has prompted village officials to request the state Department of Transportation to take another look at the intersection.

The request was prompted following brief discussion of the matter at a recent village council meeting. Village Manager Lou S. LaPonsie said he has requested a transportation official to observe the intersection and determine whether the traffic might warrant installation of a traffic signal.

An apparent increase in congestion, partly due to the recent opening of 2 new businesses at the west end of the village, is one reason for the request, LaPonsie said, adding, "The other concern is that the traffic coming from out of town still isn't slowing that much."

"There are times when the intersection is busier than at other times, but it's a busy intersection," LaPonsie noted. Doerr Road is used by many employees from General Cable Co. and Walbro

Corp., and from persons entering or leaving the village's Industrial Park.

Elwyn Helwig, who chairs the council's Streets Committee, agrees.

Aside from new business, the Charmont Motel is adding on rooms, and "that is going to cause more traffic," he remarked.

"My point was people were complaining about the time they had to spend to get into the intersection," Helwig said.

That same complaint prompted village officials to ask transportation department official David Van Hine, district traffic and safety engineer, to take a look at the intersection nearly a year ago.

The results of an hour-long observation by Van Hine, however, showed traffic volume at Doerr Road and Main Street wasn't excessive enough at that time to warrant consideration of a traffic signal.

According to Van Hine's report, 99 vehicles were observed between 3 and 4 p.m. Feb. 10, 1987. Of those

vehicles, 38 turned left from Doerr Road onto Main Street and the remaining 61 turned right.

Van Hine reported that vehicles making a right turn waited an average of 3.90 seconds, with half waiting less than 2 seconds to make their turn. Left-turning vehicles waited longer—an average of 10.61 seconds,

with half waiting less than 8 seconds.

"To put this into perspective," Van Hine said in his report, "the existing traffic signal at Seeger Street has 36 seconds of 'red' time. If you first miss the yellow signal indication, you will wait 36 seconds before receiving a green signal. Only

Please turn to page 16.

Caro man dies in car crash

A 25-year-old Caro man was killed and another Caro man remains hospitalized following a one-vehicle crash early Friday morning on the grounds of Caro Community Schools.

Lee M. Lipan was pronounced dead at the scene, a spokeswoman at the Caro Police Department said.

A passenger in the vehicle, Mark L. Flikkie, 28, was listed in "critical" condition Monday at St. Mary's Medi-

cal Center in Saginaw.

The spokeswoman said Lipan was westbound on Lincoln Street at about 12:45 a.m. when his vehicle crossed Hooper Street, entered the school grounds and traveled about 200 feet before hitting a tree. Lincoln Street ends at Hooper Street, which runs north-south.

There were no visible signs of skid marks or that brakes were applied, according to the spokeswoman, who said neither Lipan nor Flikkie was wearing a seat belt.

The Caro Fire Department's Jaws of Life were used to remove the pair from the vehicle.

The accident, Caro's second traffic related fatality in the past 6 1/2 weeks, remains under investigation.

Benefit Planned

You can do yourself a favor and help an area resident at the same time if you attend the benefit dinner and bake sale scheduled at the Evergreen Township School Gym in Shabbona Saturday from 5 p.m. to 8 p.m.

That's when neighbors and friends are staging a spaghetti dinner to help defray expenses incurred by the family in the continuing treatment of George Sangster, 45, who suffers from cancer.

The suggested donation for the supper, sponsors say, is \$3.00 each for adults, and \$1.50 for children under 10.

Glory pheasant days recalled

Army ready for Tuesday opener

A number of area residents will join the state's army of hunters next week when the firearm deer season gets underway.

The opener holds much optimism—conservation officials say they expect another record kill.

But the season also has sparked the memories of some Cass City area hunters who remember a time when the fall "opener" in the Thumb had little to do with deer. Rather, it meant some of the best pheasant hunting in the state.

Back in the 1930s, 40s, 50s and even into the 60s, the pheasant season here wasn't merely popular; it was celebrated throughout the community.

"They used to close down some of the business. They even let school out on opening day," Cass City resident and avid bird hunter Fred Leeson remarked. "It was quite an event."

Although the pheasant population has since dwindled, while the deer numbers have exploded, Leeson said he still prefers bird and small game hunting. He doesn't hunt deer anymore.

Another area hunter, Howard Muntz, recalled the abundance of pheasants locally.

"They were really thick, like chickens," he explained. "I can't remember what the bag limit was, but you had no trouble getting your limit; you could do it in a half hour."

Muntz, who noted there were few deer around at that time, added, "There were just people hunting all over. You had a lot of people

coming up from the cities." Now, he said, "We occasionally see one (pheasant), but you don't see them that often."

Muntz said he likes to hunt for deer, but would also like to see the pheasant numbers grow again.

HEYDAY

Former Cass City businessman and avid hunter Phil Retherford also remembers the pheasant's heyday in the Thumb.

"They had a hunters' ball and everything else the night before the pheasant season opener," he recalled. "They (hunters) came from all over."

"About the 1950s is when the deer started coming. Before that it was all pheasants," Retherford commented. "The limit was 2 a day and 8 in a season, but there weren't many that paid that much attention to it."

Retherford said he doesn't hunt anymore, but noted he'd rather hunt pheasant than anything else.

He recalled that seeing a flock of 15 to 20 pheasants wasn't uncommon years ago, and that it took only a short time to bag a limit.

Avid hunter Larry Groombridge of Cass City recalled similar memories.

Groombridge wasn't old enough to hunt during the earlier days, but he said he remembers the success hunters enjoyed.

"Five minutes into the season, if you were a good shot, you should have your limit," he commented. "Pheasants were in your backyard, it seemed, but you never saw any deer at that time."

Groombridge, who prefers deer hunting, also remembers ladies aid groups from churches in the Shabbona area putting on a dinner at Shabbona Hall for pheasant hunters.

The Thumb was really noted for pheasant at that time," he continued, adding he noticed that as the pheasant population dropped, other bird numbers, such as the partridge, increased.

POPULATION SHIFT

With the Thumb deer and pheasant populations having shifted over the past several years, the Department of Natural Resources is attempting to increase pheasant numbers while at the same time pare the deer population.

And although hunters in Michigan bagged an estimated record of more than

337,000 deer last year, DNR officials say the kill wasn't enough. This year's total deer kill is expected to top 400,000.

The state's large deer herd, estimated at 1.5 million animals, is the result of high herd survival rates due to milder than usual weather in the lower peninsula and an average Upper Peninsula winter last season.

In an attempt to reduce the herd, the DNR is allowing more deer to be taken in certain areas, including portions of the Thumb, where crop damage from deer feeding is prevalent.

According to DNR Wildlife Biologist Bud Jarvis, crop damage has been a problem locally. Jarvis this summer issued 3 times the normal number of special deer permits for crop dam-

Please turn to page 10.

Milton Soldan

85-year-old gored by bull

Milton Soldan, 7136 Kelly Road, Cass City, was seriously injured Friday when he was gored by a 6-year-old bull while visiting at a neighbor's farm. The 85-year-old resident suffered several broken ribs, a punctured lung and cuts and bruises.

He is lucky to be alive, said his wife Monday, while discussing the accident. It happened about noon and Soldan was found in his car by the neighbor getting ready to drive himself to the

hospital. He had to be convinced before he allowed a friend to drive him to the emergency room at Hills and Dales Hospital.

It would have been all over for him if that bull had horns, Mrs. Soldan said. As it is, everything is looking good now. He was sitting up in a chair in his hospital room Monday afternoon, she said. It was not known Monday how long Soldan would be in the hospital.

World War I veteran

French honor Lewis Bishop, 90



IT SEEMED FITTING Saturday, with Veteran's Day approaching, that World War I veteran Lewis Bishop, Cass City, would be honored with a dinner and certificate of appreciation from the French government. All area veterans, including (above, left) Bishop, retired Navy Chaplain Capt. Stanley Beach and fellow WWI veteran Vernon McConnell, will be honored on Veteran's Day Friday, Nov. 11.

About 60 persons attended a dinner in honor of Cass City resident and World War I veteran Lewis Bishop Saturday evening at the Cass City Veterans of Foreign Wars Post Hall.

Post 3644 member Jack Esau surprised Bishop with a certificate from the government of France in appreciation for services rendered during WWI.

Bishop, who will be 91 in December, spent 21 months overseas as a member of the U.S. Air Corps, which was attached to the English Air Corps. He began his service in 1917, spending 6 months in England and a full year in the Argonne Forest area in France, where he served as a reconnaissance photographer.

A ruptured appendix forced Bishop to return to the United States in the spring of 1919.

According to Esau, officials at the French Embassy in Washington estimate there are about 2,000 living American WWI combat veterans who served in France. To date, about 1,750 have received certificates of appreciation.

Among those in attendance Saturday were Bishop's family and fellow WWI veteran Vernon McConnell, also of Cass City, who earlier this year received a certificate of appreciation from the French Government for his role in the war. McConnell, 92, was a sergeant in the Army.



HARDEE'S AREA VII Vice-President Robert Haberkamp and store Manager Penny Serour presented a \$200 check to the Cass City High School Student Council during Thursday's ceremony. Accepting the check on behalf of the council is Wendy Weaver, junior class president. Hardee's officials also announced it will sponsor a "Player of the Week" program starting with boys' varsity basketball.





Mr. and Mrs. Donald J. Humpert

Ellen Louise Palmer and Donald John Humpert were united in marriage Sept. 24 at St. Elizabeth's Catholic Church in Reese. Father William O'Shea officiated at the ceremony.

The bride's parents are Leo and Christine Palmer of Cass City. The groom is the son of Jack Humpert of Reese and Judy Humpert of Frankenmuth.

Given in marriage by her parents, the bride chose an ivory satin gown designed with a bateau neckline, low plunging V-back, fitted

bodice accented by beaded Alencon and silk Venice lace, long straight sleeves with puffed shoulders, a full skirt with lace trimmed hemline flowing into an attached chapel train, highlighted by lace detail center back. Her tiara headpiece, trimmed with pearls and silk flowers, was designed and made by her cousin, Ruthann LePard. She carried a cascade bouquet of pink and ivory silk roses and orchids including handmade ribbons, made by her Grandmother Phillips.

Maid of honor was Martha VanCamp of Orlando, Fla., friend of the bride. Bridesmaids were Amy Monroe and Jennifer Palmer, sisters of the groom, and Darcie Humpert, sister of the groom.

Best man was Keith Humpert, brother of the groom. Groomsmen were Daryle Mahnke, cousin of the groom, Brian Bauer, James Squanda, friends of the groom. Ushers were David Monroe, brother-in-law of the bride, and Dallas Mahnke, cousin of the groom. Ringbearer was Brian Phillips, cousin of the bride.

Vocalists were Tom and Mindy Fulcher of Cass City. The reception was held at the Knights of Columbus Hall in Essexville following the wedding.

The couple honeymooned in Waikiki Beach, Hawaii.

They are making their home in Frankenmuth where he is employed as an accountant for the Frankenmuth Bavarian Motor Lodge. The bride is a Medical Lab Technician at St. Joseph's Hospital in Flint.

### 4-H youths attend food program

More than 60 young people attended a foods program sponsored by H.J. Heinz Company that was hosted in Tuscola County.

"This Oct. 29 program was our first of this type and with as much excitement as we had it could be an annual program," John Wurm, 4-H Youth Agent, stated. "We had 4-H parents and leaders come in to teach about such foods as caramel apples, sugar nuts, caramel corn, pita pockets and cake decorating."

The program gave youth the opportunity to try some hands on activities and even go home with a shoe box full of food. In addition to all of the treats, the youth received a copy of a special cookbook put together by 4-H leaders.

The committee that put the program together included Barbara Haas and Pat LaBair of Mayville, Jackie Colosky, Sharon Allen and Wilma Counts, all from Vassar and John Wurm.

In addition to the planning committee the following people taught mini food options: Rita Pishel, Sally Welke and Sherry Bodeis of Mayville and Estelle Johnson of Fostoria. Rick and Peggy Kuhr also demonstrated the production of apple cider.

"This was quite an educational program and we had a lot of fun doing it," Wurm concluded.

### Rides offered to area seniors

Senior citizens in Tuscola, Huron and Sanilac counties can again get transportation help through the Human Development Commission.

Transportation is available to doctor's appointments, to the pharmacy for prescriptions, to the hospital for treatments or important business appointments. HDC also provides rides to meal sites.

Donations are accepted and appreciated. Additional information is available by calling Pearl at 1-800-843-6394.

### Hills and Dales General Hospital

PATIENTS LISTED MONDAY, NOV. 7, WERE:

Alvin Avery, Delphenia Bean, Florence Ingles, Preston Karr, Lawrence Miller, Michael Williams, Cass City;

Eva Luther, Unionville; Betty Olsow, Lynda Rocheleau, Gageton; Matthew Woudstra, Decker;

Betty Daley, Deford; Timothy Bye, Snover; Neva Gilmore, Kingston.

## Cass City Personal Items

Audrey Katzenberger

Phone 872-3049

Mr. and Mrs. Lawrence Brown, their son Paul and his wife Jane of Harlem Springs, Ohio, were in Cass City Tuesday to attend the funeral of Lawrence's step-sister, Mrs. Laura McQueen.

Carolyn Tuckey and 3 of her classmates in East Lansing spent the weekend with Mr. and Mrs. Roy Tuckey.

Mrs. Edith Ferrenburg, Mrs. Pauline Bernhard, Mrs. Leone Whitzel and Miss Helen Ferrenburg of near Toledo, Ohio, attended the funeral of their aunt, Mrs. Laura McQueen, Tuesday. Mrs. Edith Ferrenburg was an overnight guest of Mrs. Hazel Seeley and the other 3 were overnight guests of Mr. and Mrs. Stanley Kirn.

Mr. and Mrs. Don Whittenburg attended the wedding of Michelle Frank and Shawn Faircloth Saturday at St. Pancratius Church.

Mr. and Mrs. Don Whittenburg had dinner Tuesday with Mr. and Mrs. Roland Dehmel in Sebawaing. Other guests were Mr. and Mrs. Larry Dehmel, son Timothy of Bay City and Mr. and Mrs. Tom Dehmel of Sebawaing.

Mr. and Mrs. Rick Lorentzen and son Danny of Clio were Saturday dinner guests of his mother, Mrs. Helen Lorentzen.

Mr. and Mrs. Wesley Ball and family of Reese and Mr. and Mrs. Don Ball and boys were Sunday dinner guests of their mother, Mrs. Laura Ball. They celebrated Sharon's birthday.

Mr. and Mrs. Amasa Anthes of Gageton visited Mr. and Mrs. Stanley Morell Friday evening.

Susan and Tim Wooster of Mount Morris were visitors of Dale and Mary Damm Saturday. They came to attend the wedding and reception of Shelly Frank and Shawn Faircloth.

The regular monthly meeting of Post 3644 VFW will be at the post hall Monday, Nov. 14, at 7:30 p.m.

Debbie and Patti Timmons and Sheree LaPeer spent Saturday afternoon with their grandparents, Mr. and Mrs. Gaylord LaPeer.

Darwin and Kimberly Farnum of Ypsilanti announce the birth of a son, Nicholas Ryan, Tuesday, Nov. 1, at St. Joseph Hospital, Ann Arbor. He weighed 7 pounds, 15 1/2 ounces and was 19 1/2 inches long. Maternal grandparents are Jean Bennett of Ypsilanti and Jack Goble of Lexington, Ky. Paternal grandparents are Willis and June Farnum of Owendale. Nicholas joins a sister, Jessica.

Mr. and Mrs. James Bolz and daughters, Minde, Tammie and Mary, of Milan spent the weekend with her parents, Mr. and Mrs. Ivan Tracy. Saturday evening they attended the Frank-Faircloth wedding.

Mr. and Mrs. Amasa Anthes and Mr. and Mrs. Stanley Morell were in Saginaw Monday.

Mrs. Donna Holm and her mother, Mrs. Lyle Zapfe, went to Flint Sunday to visit Clarence Zapfe in a Flint hospital.

Mr. and Mrs. Stanley Morell and Mrs. Helen Lorentzen attended the funeral Friday of Emmet Kritzman of Deckerville.



**Meg's Peg**

**Lo-cho. recipes**

by Melva E. Guinther

Actor James Garner, who appeared on the Johnny Carson show Friday night, had succeeded in lowering his cholesterol level from the dangerous zone around 275 to 159, primarily by changing his diet.

Garner had little choice. He had already survived surgery for 4 heart bypasses and an aortal aneurysm.

Most of us are concerned with keeping our cholesterol levels under control. Sometimes, though, when con-

fronted with the long list of no-nos and the few acceptable foods, it seems as if the joy of eating must be a thing of the past.

Angel food cake is one of the few desserts allowed in a low cholesterol diet. Betty Crocker has come up with a neat little recipe book designed to perk it up and make angel food a little more interesting.

Here are a couple of recipes that have zero cholesterol and very few calories.

**FRUIT TRIFLE**

1/2 of an angel food cake  
1 can (15 1/4 oz.) crushed pineapple, drained  
1 can (11 oz.) mandarin orange segments, drained  
1 pkg. (.9 oz.) sugar-free vanilla instant pudding  
1 envelope whipped topping mix  
1/4 cup chopped walnuts  
6 maraschino cherries with stems

Tear cake into small pieces. Mix pineapple and orange segments. Prepare pudding as directed on package, except use skim milk. Layer half each of the cake pieces, fruit mixture and pudding in a 2-quart serving bowl. Repeat. Prepare topping mix, using skim milk, and spread over the top. Sprinkle with walnuts and garnish with cherries. Refrigerate at least 2 hours.

**CRUNCH CAKE**

3/4 cup coarsely crushed Wheaties or Total cereal (about 1 1/2 cups uncrushed)  
1/2 teaspoon ground cinnamon  
1 pkg. white angel food cake mix

Heat oven to 350. Mix cereal and cinnamon. Prepare cake mix as directed on package and fold cereal mixture into batter. Pour into ungreased 12-cup bundt cake pan and bake as directed. Serve with fresh fruit.

## Cass City tutors air Nov. 2 mee.

The Cass City Literacy volunteer tutors held their monthly meeting Nov. 2 at Rawson Memorial Library in Cass City.

Tutors present were Gloria Hartwick, Elaine Makas-Howard, Jane Hitler, Evelyn MacRae and Ellen Toner.

A Christmas party for tutors and students will be held in December. This will be the first time all students and tutors have assembled as a group. There are currently 9 students and 9 tutors.

The Cass City volunteer tutors will sponsor a training session for new tutors in February. The sessions will run for 3 nights, 4 hours each. Each tutor must have 12 hours of training before they are assigned a student. Anyone interested in becoming a tutor can contact Evelyn MacRae at 872-3365.

The tutors had an opportunity after the meeting to view the new CHALLENGER reading series that has recently been made available for use by tutors and students. It is an advancement of the LAUBACH reading series currently in use.

The next regular meeting of the group will be held Jan. 4 and will feature a film on adult literacy.

### Advertise It In The Chronicle

**HILLS AND DALES GENERAL HOSPITAL**  
872-2121

EVENT	DATE	TIME	PLACE
Dr. Girgis Urologist	Nov. 15	9 a.m.-11 a.m.	Clinic
Dr. Donahue	Nov. 16	8-11 a.m.	Clinic
Dr. Jeung	Nov. 18	8-11 a.m.	Clinic
Overeaters Anonymous every Monday 4-5 p.m.			
Immediate Care Clinic available Fri. 6 p. m. through Mon. 6 a.m. and Holidays in the Ambulatory Care Center.			
Thumb Area Home Care call (800) 358-4749 Physical, Respiratory and Speech Therapy plus Mammography available.			
Home Care Equipment call 872-2121 ext. 250 Party Take-Out Food Available.			

### Marriage Licenses

Kenneth Woolwine and Jenny Hyde, both of Millington.

Mitchell Drew, Vassar, and Ronda Closson, Clio.

In Hak Kim and Aeyong An, both of Millington.

Earnest Ostrom and Joyce Wichert, both of Millington.

James Douglas and Deloris Smith, both of Vassar.

Arthur Belin III and Ann Marie McAlpine, both of Kingston.

Donald Smith Jr. and Sally Stilson, both of Cass City.

**CASS CITY BAND PARENTS**

**STOP - LOOK - LISTEN**

If you need an instrument for your son or daughter for beginning band, be sure to call Kohn Music to compare prices.

The instruments we carry are all director-approved and our prices are for complete packages--no hidden costs whatsoever. The only thing additional to our price is the 4% Michigan sales tax.

Kohn Music has a company representative in Cass City every Tuesday, Wednesday, and Thursday. If you need any music supplies or service for your instrument, our representative can pick up and deliver instruments for repair or deliver band instrument supplies to you.

We guarantee that we will save you \$150 to \$300 on a new band instrument versus what your "school-selected" vendor is asking you to pay for an instrument. Many of the teachers, school board members, and administrators of the Cass City school district take advantage of our savings. The parents of students in Cass City should be able to take advantage of these savings as well.

When you think of music, think of Kohn Music in Sandusky, serving the Thumb area and promoting music education for over twenty-eight years.

Call Us Before You Buy!

**Kohn's Music Store**  
54 S. ELK STREET SANDUSKY, MICHIGAN 48471  
PHONE 313-648-2095

**For Health Insurance That's A Cut Above The Rest**

Consider the 24 Karat Major Medical Plan from Time Insurance. Time's plan outlines the competition because more value has been built into every benefit you receive. Values like:

- Freedom to choose your doctor and hospital
- 15% non-smoker's discount
- Prescription drugs, ambulance, and x-ray coverage
- 100% coverage for pre-admission testing, second surgical opinions, home health care and more.

In addition, because the 24 Karat is a hospital pre-certification plan, it uses a system of managed health care to ensure that every hospital treatment and service you receive is medically appropriate for you. For more information contact:

**Harris & Company**  
Newell E. Harris  
517-872-2688  
Cass City

TIME INSURANCE COMPANY

**COULTER FARM SERVICE INC.** is Introducing **PET SHUR-GAIN FOODS**

45# \$14.99

45# \$11.99

18# \$10.99

18# \$10.99

18 lb. \$9.99

**FREE SAMPLES**

Hours: 8 - 5 Weekdays, 8 - 12 Saturday

Located: 4155 Vulcan St., Cass City, 872-3732



"If It Fitz..."

I hated it

By Jim Fitzgerald

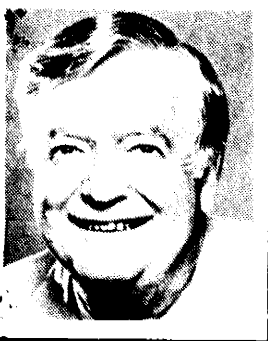

Last week, my 19-year-old granddaughter did the same thing I did when I was 19, in 1945. She returned to her Michigan home from Munich. It is something for an old poop to think about.

Michele was on vacation with two other girls. They were invited to stay in the homes of traveling Munich musicians they met at a German festival this summer in Frankenmuth. Forty-three years earlier, on my visit to the Munich area, with no invitation, I stayed in a tavern, sleeping behind the bar.

I arrived there toward the end of World War II, an inadequate replacement in the 12th Armored Division. I was an assistant half-track driver, which meant I washed it.

Conquering soldiers moved in where they pleased and worried little about where the displaced enemy might go. My armored infantry company took over a beer garden in a tiny farming village near Munich. The second floor had been converted into a makeshift garment factory where women made military uniforms. In one big room, two dozen sewing machines were lined up like school desks.

The tavern keeper and his family lived on the job, and there were five bedrooms in the building. I remember clearly because, as one of the new guys, I didn't get a bed. I spread my sleeping bag behind the bar, which, unfortunately, was dry. Not one full bottle or keg. Thirsty troops had preceded

us. **BREAKING THE GARBAGE RULES**

Those troops had done their job — killing and destroying. The evidence of their effectiveness could be seen in the occasional charred German tank and in the shot-up buildings of Munich. This evidence could also be seen in the eyes of the German people on the streets. I avoided their sullen glances, but I felt them. I wondered which of them had to move out of the tavern building because I moved in.

There were almost no young German men on the streets. Just old men and women of all ages. And little children who snatched the American soldiers' cigaret butts as soon as they hit the ground. Children who stood beside the garbage cans outside our mess tent and silently begged us to scrape out our mess kits into their hands or containers.

Once in awhile I drew garbage detail. That meant riding the garbage truck to a dump outside town and shoveling the stinking refuse into huge piles. The little children were there, too. They picked through the garbage, sticking the most choice bits of rotting food into tin cans to take home to their families.

Most of the conquering soldiers tried to steer the cleanest garbage toward the children. We also gave them candy. We weren't supposed to. During those last weeks of the war, and for a while after, there was a birthday — with no desire to return.

"non-fraternization policy" that forbade the occupying army from any sort of social contact with the enemy.

But what were we supposed to do, blame the children for Hitler and his followers? Punish them for the unbelievably obscene things that adults did in a Munich suburb called Dachau?

**PROGRESS, AFTER 43 YEARS**

I hated it in Munich, mainly because of those children grasping for garbage. They were the same age as my little sisters back home. I was happy to get out of there, sailing for home on Aug. 5, 1945 — my 19th birthday. Forty-three years later, my 19-year-old granddaughter was sorry to leave Munich. She had a great time and wants to go back. Splendid. That's progress in international fraternizing and I yearn for much more of the same — everywhere.

And I wonder about those little children at that garbage dump in 1945. They'd be around 50 years old today. Did one of them, just by chance, pass near my granddaughter on a Munich street in 1988? Did one of them ever have a bedroom over a tavern, near two dozen sewing machines? Did he or she have to move out quickly when the Americans moved in?

It is something for an old poop to think about, and damn near cry.



**MITTEN BAY GIRL Scout Council officials gathered last week in Bad Axe for a reception in honor of newly hired Executive Director Jeanne Nelson. Among those attending were (from left) Mitten Bay Board Director Bob Stickle, Field Director Julie Witherspoon, Nelson, President Elsie Schrader and area Service Unit Director Kay Warner.**

**Car reported stolen**

**No driver at crash scene**

Troopers from the state police post in Caro were unable to locate the driver of a vehicle that crashed Friday evening in Wells Township.

Reports state the vehicle was southbound on East Dayton Road south of Riley Road at about 10:45 p.m. when it ran off the right shoulder of the roadway, struck a sign, re-entered the roadway, again lost control and ran off the left side of the road. The vehicle then entered a ditch and rolled over at least twice before coming to rest on its top.

Troopers and several persons at the scene conducted a search for the driver, but no one was found.

The owner of the vehicle, Terry L. Vandemark, 2168 Remington Rd., Caro, told troopers the vehicle had been stolen sometime after

8:30 p.m. the same evening while parked at the Crestwood Lounge in Caro.

**Music, mission weekend slated**

A music and mission weekend is scheduled at the Evangelical Free Church in Cass City Nov. 12-13.

The program will be started with a supper at 5:30 p.m. Saturday and persons attending are asked to bring a dish to pass.

At 7 p.m. Buddy Greene, a harmonist who travels with the Bill Gaither group, will be featured.

Sunday morning at 11 o'clock Richard Adkins of Tenya, Africa, will speak. He works in radio and television and makes VCR tapes in connection with his missionary work.

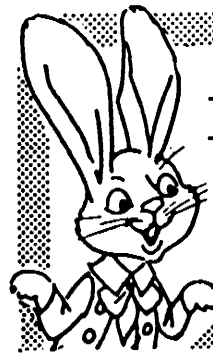

**Rabbit Tracks**

by John Haire  
(And anyone else he can get to help.)

How cold was it in October? Colder than you thought, I'd wager. According to National Weather Service statistics, it was the coldest October on record for lower Michigan. Records date back to 1925 and in the 63 years, last month was the record setter.

The average high temperature in October was 54.2, the average low, 37.7. Normal averages are 62.2 and 41.2.

Greg Thompson, Cass City, gets our vote as the top moonlighter in the village. In addition to his regular job with Gen-Tel, he helps deliver the Detroit News in the morning. Hits town about 4 a.m., ready to go to work. That is Moonlighting with a capital M.

Say it isn't so department. Just as I was getting accustomed to not getting rid of by burning about half the leaves in town that congregate in my yard, Gov. James Blanchard has a new recommendation.

He recommends a law that will not only ban burning state-wide, but also ban putting them in a landfill.

His solution? A compost pile. (And isn't that a lot of fertilizer?)

It's hard to say for sure what might happen by the end of the week, but if all goes according to plan, the Haires will be at Evergreen Township School Saturday night to attend the Sangster benefit dinner.

That doesn't earn any hero medals for us or anyone else that attends. You always get more than you pay for at one of these shindigs. There's only one drawback. All those luscious baked goods just K-I-L-L any and all diets.

**The Weather**

	High	Low	Precip.
Tuesday	42	38	.05"
Wednesday	31	23	0
Thursday	54	44	.03"
Friday	62	52	.17"
Saturday	60	40	1.03"
Sunday	40	30	.21"
Monday	46	38	.15"

(Recorded at Cass City wastewater treatment plant.)

**The Want Ads Are Newsy Too!**

**The Haire Net**



Big deal, my wife sniffed, as she delved into a story in one of the daily papers that comes to the house. The story that was treated with such disdain concerned a 12-year-old girl who climbed into the family car and, using 2 pillows for leverage, drove it for 100 miles.

She had been driving for 2 1/2 hours before she was stopped and coaxed into a parking lot by a police officer.

You need to know the background before you can understand why the story generated so much disdain in the Haire household. Way back in the dark ages when we were that age, a 12-year-old driving was nothing unusual. Dorothy drove to school every day at 12 and by that advanced old age, I had been dragging around the back roads for 3 years.

There were a variety of

reasons for driving at a young age in farm communities at the time. One was that there were no school busses (We paid for our books and pencils, too, but that's another story.) and kids either were in a car pool or walked.

Sure, things were different then. But not as much different as you'd imagine a half century later. There were fewer cars, but the roads were less wide, couldn't accommodate the traffic during peak periods. Nothing changes much, does it?

In Pinconning where we lived, M-13 (then U.S. 23) was a 2-lane road and on Sunday afternoons it was as jammed as I-75 at the old Zilwaukee bridge when a boat was going through.

To tell the truth, I think that both of us were lawbreakers. If memory serves, the legal age was 14. But no one paid too much attention to that and by the time it was legal to drive, everyone who had access to a car was a veteran with 100's of miles under his or her belt.

There were plenty of accidents involving student drivers, legal and non-legal, but none that resulted in funerals or life-time disfigurement.

It would be nice to brag that all this was because we were better drivers in those days. The truth is that the kid behind the wheel hasn't changed much. Just like today, there were the rash drivers, the timid drivers, the cautious drivers and the take-a-chance stupid ones.

I can remember piling about 10 in a car to drive to the ball diamond and ending upside down in the ditch because the driver attempted to take a corner too fast. Now that would get you a ticket, at least. Then we all jumped out, pushed the car upright and out of the ditch and went to practice.

I suspect that there were probably more accidents then per mile driven than there are today, but can't prove it.

How do I account for the lack of serious accidents in 10 years I drove while going to school?

As the guy said, I'd rather be lucky than good.

**PEPSI**  
8 - 1/2 liters  
**\$2.79**  
Plus Dep.

**LOTTO Daily**

**Quaker Maid**  
Mon.-Fri. 7:30 a.m. - 10:00 p.m.  
Sat. & Sun. 8:00 a.m. - 10:00 p.m. Main Street

**BOB WANTS YOUR HARVEST**

**BRING US YOUR BEANS & CORN**

**COMPETITIVE RATES & UP TO THE MINUTE PRICES**

We are still receiving

- CORN
- SOYBEANS
- NAVY BEANS
- COLORED BEANS

FAST, EFFICIENT UNLOADING  
FERTILIZER SPREADER AVAILABLE  
STORAGE AVAILABLE

For your convenience We have extended hours during harvest

**Con Agri. BERGER AND COMPANY**  
A ConAgra Company  
6210 Main St. Phone: (517) 872-2171

**Radio Shack**

**3-DAY BLOWOUT SALE**

**Armstrong Solarian Supreme**

*The last word in elegance from the first name in floors.*

Nothing looks as dazzling as Armstrong Solarian Supreme—because nothing is made like it. The designs are rich, the colors exquisite.

And Solarian Supreme stays beautiful, too. Its Mirabond® XL surface keeps its like-new look far longer than other vinyl no-wax floors.

Come see an uncommonly elegant no-wax floor. Come see Solarian Supreme.

**From \$3.99**

**Armstrong**

IT ALL STARTS WITH LOW PRICES!! **SUPERSTORE!**

**Schmeberger's**  
Cass City Phone: 872-2696

APPLIANCES TV FURNITURE  
Instant Credit Service After The Sale!

HOURS:  
8 a.m. to 5:30 p.m., Daily  
8 a.m. to 9 p.m., Friday  
8 a.m. to 5:30 p.m., Saturday

# CASS CITY PUBLIC SCHOOLS

CASS CITY, MICHIGAN

Year ended June 30, 1988

## COMBINED BALANCE SHEET — ALL FUND TYPES AND ACCOUNT GROUP

ASSETS AND OTHER DEBITS	GOVERNMENTAL FUND TYPES			FIDUCIARY FUND TYPES	ACCOUNT GROUP	JUNE 30, 1988 TOTALS (MEMORANDUM ONLY)	JUNE 30, 1987 TOTALS (MEMORANDUM ONLY)
	GENERAL	SPECIAL REVENUE	DEBT RETIREMENT	STUDENT ACTIVITY	GENERAL LONG-TERM DEBT	COMBINED TOTAL	COMBINED TOTAL
<b>CURRENT ASSETS:</b>							
Petty cash	\$2,598					\$2,598	\$135
Cash in bank-commerical (Note 2)	326,301	\$4,241		\$35,337		365,879	136,034
Cash in bank - payroll	58,722					58,722	2,402
Cash in bank - Chapter I			\$62,706			62,706	
Cash in bank - savings							28,777
Accounts receivable		12,389				12,389	4,394
Accounts receivable - Title I	3,596					3,596	
Due from Chapter I	3,146					3,146	
Due from School Service Fund	13,136					13,136	15,425
Taxes receivable							489,123
<b>TOTAL CURRENT ASSETS</b>	<b>407,499</b>	<b>16,630</b>	<b>62,706</b>	<b>35,337</b>		<b>522,172</b>	<b>676,290</b>
AMOUNT AVAILABLE AND TO BE PROVIDED FOR PAYMENT OF GENERAL LONG-TERM DEBT					\$780,979	780,979	844,823
<b>TOTAL ASSETS AND OTHER DEBITS</b>	<b>\$407,499</b>	<b>\$16,630</b>	<b>\$62,706</b>	<b>\$35,337</b>	<b>\$780,979</b>	<b>\$1,303,151</b>	<b>\$1,521,113</b>
<b>LIABILITIES AND FUND BALANCE</b>							
<b>CURRENT LIABILITIES</b>							
Accounts payable	\$50,197	\$518				\$50,715	\$30,301
Accrued salaries & wages	56,658					56,658	53,023
Accrued employee benefits							70,492
Due to General Fund (Note 7)		13,136				13,136	15,425
Due to student organizations							28,956
Deferred revenue	4,824			\$35,337		40,161	
Accrued payroll taxes	88,628					88,628	
<b>TOTAL CURRENT LIABILITIES</b>	<b>200,307</b>	<b>13,654</b>		<b>35,337</b>		<b>249,298</b>	<b>198,191</b>
<b>LONG-TERM DEBT:</b>							
General long term debt (Note 5&8)					\$780,979	780,979	844,823
<b>FUND BALANCE</b>	<b>132,428</b>	<b>2,976</b>	<b>\$62,706</b>			<b>198,110</b>	<b>373,072</b>
<b>FUND BALANCE - RESTRICTED (Note 6)</b>	<b>74,764</b>					<b>74,764</b>	<b>105,027</b>
<b>TOTAL LIABILITIES &amp; FUND BALANCE</b>	<b>\$407,499</b>	<b>\$16,630</b>	<b>\$62,706</b>	<b>\$35,337</b>	<b>\$780,979</b>	<b>\$1,303,151</b>	<b>\$1,521,113</b>

The accompanying notes are an integral part of the financial statements.

## COMBINED STATEMENT OF REVENUES, EXPENDITURES AND CHANGES IN FUND BALANCES - ALL GOVERNMENTAL FUND TYPES

Year ended June 30, 1988

	GENERAL	SPECIAL REVENUE	DEBT RETIREMENT	JUNE 30, 1988	JUNE 30, 1987
				TOTALS (MEMORANDUM ONLY)	TOTALS (MEMORANDUM ONLY)
<b>REVENUES:</b>					
Local sources	\$2,698,728	\$138,380	\$119,120	\$2,956,228	\$3,189,885
State sources	1,511,331			1,511,331	1,218,959
Federal sources	101,578	83,949		185,527	165,279
<b>TOTAL REVENUES</b>	<b>4,311,637</b>	<b>222,329</b>	<b>119,120</b>	<b>4,653,086</b>	<b>4,574,123</b>
<b>OTHER FINANCIAL SOURCES:</b>					
Special education	30,716			30,716	72,578
<b>TOTAL OTHER FINANCIAL SOURCES</b>	<b>30,716</b>			<b>30,716</b>	<b>72,578</b>
<b>TOTAL REVENUE &amp; OTHER FINANCING SOURCES</b>	<b>4,342,353</b>	<b>222,329</b>	<b>119,120</b>	<b>4,683,802</b>	<b>4,646,701</b>
<b>EXPENDITURES:</b>					
Instruction	2,671,107			2,671,107	2,519,389
Supporting services	1,683,066			1,683,066	1,515,741
Community services	103,316			103,316	90,647
School activities		285,364		285,364	274,116
Capital outlay	39,330	3,270		42,600	31,407
Debt service			103,893	103,893	123,921
<b>TOTAL EXPENDITURES</b>	<b>4,496,819</b>	<b>288,634</b>	<b>103,893</b>	<b>4,889,346</b>	<b>4,555,221</b>
<b>OTHER FINANCING USES:</b>					
Fund modification & transfer to Athletic Fund	46,275			46,275	51,559
To Cafeterial Fund	7,540			7,540	(135)
From General Fund		(54,135)		(54,135)	
<b>TOTAL EXPENDITURES &amp; OTHER FINANCING USES</b>	<b>4,550,634</b>	<b>234,499</b>	<b>103,893</b>	<b>4,889,026</b>	<b>4,606,645</b>
<b>EXCESS OF REVENUES &amp; OTHER FINANCING SOURCES OVER EXPENDITURES &amp; OTHER FINANCING USES</b>	<b>(208,281)</b>	<b>(12,170)</b>	<b>15,227</b>	<b>(205,224)</b>	<b>40,056</b>
<b>FUND BALANCE - JULY 1</b>	<b>415,473</b>	<b>15,146</b>	<b>47,479</b>	<b>478,098</b>	<b>438,044</b>
<b>FUND BALANCE - JUNE 30</b>	<b>\$207,192</b>	<b>\$2,976</b>	<b>\$62,706</b>	<b>\$272,874</b>	<b>\$478,100</b>

The accompanying notes are an integral part of the financial statements.

### SCHOOL INFORMATION

The 1987-88 audit shows a deficit for the year in the General Fund of \$208,281. The General Fund balance decreased from \$415,473 to \$207,192. Of the \$207,192 fund balance \$74,764 is restricted for asbestos abatement, leaving an unrestricted fund balance of \$132,428. When considering the General Fund balance, it should be kept in mind that there is \$200,979 in bus notes which the district is responsible for from general revenues.

One of the primary reasons for the deficit was due to a loss of 41 students in the total district enrollment. This student decrease resulted in revenue losses of nearly \$100,000.

All debt retirement payments were made on schedule and the accounts retain sufficient balances to meet payment needs.

During the past year the major maintenance project for the school system was the asbestos abatement project. All identified asbestos insulation materials in all of the school's boiler and air handling rooms have been removed and replaced with non asbestos materials.

	1986-87	1987-88
No. Bldgs	5	5
No. Classrooms	90	90
Value of Equip.	1,292,105	1,579,842
Value of Bldgs.	10,831,637	14,485,963
Res. Day Pupils	1,641	1,595
Non-Res. Day Pupils	21	17
Teachers Salary Schedule		
Minimum	17,854	19,889
Maximum	30,711	32,632
No. Teachers	73	72
Ratio of Regular Pupils to Cert. Employees	20.2 to 1	20.3 to 1



# Area mother, volunteer share year of support

by Tom Montgomery  
News Editor

of questions about their son, Shawn, in the weeks following his birth 13 months ago. The Gagetown area couple encountered frustrations typically encountered by

new moms and dads. There was uncertainty that what they were doing and feeling was "okay."

The Gaeths' transition to parenthood was eased, however, with the help of a new tri-county volunteer program, which provided support and more.

The program, Care and Response Enabling Self Sufficiency (CARESS) for new mothers, was established about 2 years ago for single or married mothers whether they're having their first baby or their eighth baby.

The program offers "support" in the form of a volunteer, who undergoes 6 hours of training (available on video tape) and then meets with the mother on a regular basis for a period of one year.

For Gaeth and her volunteer, Berniece Abbe of Owendale, who recently completed their year together, the program has provided not only a helping relationship, but also a lasting friendship.

"It's meant a lot to me to be able to ask any questions whether they were stupid or not, and not have someone force their opinions on me," Gaeth remarked during a recent interview at her home. "I don't think it (relationship) will stop now. I think we'll continue to be good friends."

"It turned out to be more than I expected," Abbe agreed, adding, "I feel like I've made a good friend."

Abbe, who has a 17-year-old daughter, noted that as a volunteer, her job has consisted largely of simply being a friend and sharing her experiences as a mother.

## OPTIONS

"Basically, we're supposed to (provide) information to the mother—give her options, be someone she can bounce questions off objectively," she explained. "It's not our role to tell the mother what to do."

Gaeth and Abbe recalled a few of the problems they've conquered during their 60 to 90-minute weekly visits over the past year.

Gaeth remembered a brief period during which her son seemed to be experiencing discomfort after breast feeding. She mentioned the problem to Abbe, who asked if she had been drinking orange juice. The juice turned out to be the culprit. "Another thing I helped Rosemary with was her feelings when she got ready to go back to work," Abbe recalled. "I tried to help her prepare" for what she would feel when she got ready to go back.

"It's difficult when you don't know what to expect of yourself," she observed, adding that often a mother simply needs to know that what she's feeling is normal and alright.

Gaeth nodded. "You always feel like you're supposed to solve your own

problems. You wonder if you're the only one who's going through this," she said.

## WILLINGNESS

Abbe indicated Gaeth's willingness to ask questions and take part in the support relationship was key in terms of what she got out of it. She pointed out that Gaeth's husband, Brian, also took an active part. "When he was there he'd ask questions."

Brian, an electrician with Sebewaing Industries, commented that his interest was sparked by a desire to understand what his wife was going through emotionally.

"I think the positive part about it is the objectivity" of the volunteer, he said, adding that after their son was born, "We were bombarded by everybody to do this or do that."

According to Ubyly resident Julia Heilig, who serves as executive director of CARESS, providing information to mothers and then allowing them the freedom to make their own decisions is the program's primary objective.

"Self sufficiency is never going to happen if someone is always telling you what to do," she remarked.

Heilig noted that the need for programs such as CARESS, the brainchild of Harbor Beach resident Marge Nilsen, has been growing in recent years.

## MOBILE SOCIETY

"We've become such a mobile society, we don't have the family support we used to," she commented, adding other changes in society, including more emphasis being placed on career selection than on the skills of motherhood, also have contributed to the need for a support network.

For the mothers, the biggest advantage of CARESS is the friendship, support and trust of another person, she continued. "Even though we don't target the men in these families... they definitely feel like they are part of" the support relationship.

CARESS matched up 15 mothers and volunteers in its first year of operation, which was made possible through about \$5,600 in seed money provided by the Reorganized Church of Latter Day Saints' Tangible Love Fund, and donations from the Huron and Sanilac CAN councils.

This year Heilig was flabbergasted with the results of her request for a \$4,500 grant from the Children's Trust Fund of Michigan.

"They called in July and because of the magnitude of the program and their belief in how badly needed it is, they gave us \$15,000," she said. The money, which allowed Heilig to begin working 3 days instead of

one, must be matched by local funds totalling 25 percent of the grant, she noted. Heilig said she hopes to match up at least 30 mothers and volunteers this year.

All will be satisfied customers if their experience comes close to that enjoyed by Gaeth and Abbe.

"It grew into a good friendship," Gaeth remarked, adding after getting to know Abbe, she was much more relaxed and able to ask important rather than trivial questions.

"She gave (me) confidence in myself, too. She always told me what I was doing right rather than what I was doing wrong."

Abbe added, "This was a situation where I've gotten more in return than I feel I have given. It's a good feeling."

*Editors note: Area women interested in taking advantage of CARESS, or groups who would like to have Heilig present a brief talk on the program can contact her at (517) 658-2170.*



**LASTING FRIENDSHIP** — A year-long mother-volunteer relationship has grown into something special for CARESS participants Rosemary Gaeth, holding her son, Shawn, above, and Berniece Abbe.

## Area motorist injured in collision

A Cass City man was treated and released from Hills and Dales General Hospital Friday following a 2-vehicle collision near the intersection of Comment Drive and Main Street in Cass City.

Injured was Duane J. White, 43, 6230 Lakeside Drive, Cass City, who was eastbound on Main Street at about 4:05 p.m. when his vehicle collided with a westbound vehicle making a left turn onto Comment Drive. That vehicle was driven by David S. Marshall, 16, 5201 Hadley Rd., Cass City.

Both vehicles sustained moderate to extensive dam-

age. Earlier Friday, an eastbound vehicle driven by Viretta B. Pena, 4285 Doerr Rd., Cass City, was backed up on Main Street at the Weaver Street intersection by another eastbound vehicle, driven by Kevin W. Czekai, 4544 Brooker St., Cass City.

Both vehicles sustained light damage in the 2:35 p.m. mishap. Also reported last week was a car-deer accident.

Betty J. Pawlowski of Filion told police she was driving east on East Cass City Road near Koepfgen Road Thursday when a deer

leaped into her path. Pawlowski's vehicle sustained light damage in the 6:45 p.m. accident.

## Cass City woman remains hospitalized after crash

A Cass City woman remained in "serious" condition at St. Mary's Medical Center in Saginaw Monday, a week after her car struck a sugar beet truck about 4 miles south of Caro.

Beiva M. Schott, 59, of Cass City was injured Oct. 31 when her northeast bound vehicle struck a beet truck from behind on M-81 at the Colwood Road intersection, according to a Tuscola County Sheriff's Depart-

ment report.

The driver of the truck, Rodney Thompson, 31, of Sebewaing, had signaled and was attempting to make a left turn onto Colwood Road when the 6:55 p.m. accident occurred.

Schott was taken to Caro Community Hospital for emergency treatment, and then transported to St. Mary's. Thompson was not injured.

Both drivers were wearing seat belts, reports state.

**BARGAIN NIGHTS..**  
MON. and TUES.  
ADULTS: \$2.00

**STRAND - CARO**  
Phone 673-3033

SUNDAY: 2:30 TILL 6:00 ALL SEATS \$1.50

Fri. thru Thurs. **NOVEMBER 11-17**

**SIGOURNEY-WEAVER**  
**GORILLAS**  
**IN THE MIST**  
The Adventure of Dian Fossey

**STARTING TIME OF FEATURE:**  
FRI., SAT., MON. & TUES. 7:30 and 10:00  
SUNDAY: 2:55 - 5:20 - 7:45  
WED. & THURS. ONCE ONLY AT...7:40

12 MONTH CD **Advertise**  
**8.25%** **It In**  
**PIONEER BANK** **The**  
North Branch **Chronicle**  
1-800-622-1999 313-669-3051

TV APPLIANCES FURNITURE  
**Schmeberger's**  
Phone 672-2555 Cass City

Starting Monday  
**STORE OPEN 8-8**

**99¢**

**\*Tape Rental**

**POP \$1.99**  
8-1/2 Liters

London Homogenized **MILK**  
**\$1.69**

**NOW RENTING**  
And God Created Woman  
E.T.  
Sunset  
Beetle Juice  
Seventh Sign  
Land of Faraway  
Serpent & the Rainbow

**OVER 3300 MOVIES TO RENT**

**NO DEPOSIT**  
**TAPE PLAYER RENTAL**  
**NO MEMBERSHIP FEE**

**COMING ATTRACTIONS**

Night Train to Katmandu  
Colors  
Cherry 2000  
Blue Iguana  
Plain Clothes

**DISNEY MOVIES**  
**WILDLIFE AND HUNTING TAPES**  
Complete set of World at War (W.W.II), Victory at Sea (W.W.II), and Ten Thousand Day War (Vietnam).

Phone 872-2252 **CASS** CASS CITY

**ENDS THURSDAY 7:30 Only**  
Clint Eastwood is "Dirty Harry"  
**THE DEAD POOL**

**STARTS FRIDAY NOV. 11-12-13 & 17**  
All Evenings (Except Sat.) 7:30  
Saturday 7:30 & 9:30

**A Fish Called Wanda**  
"the slappiest slapstick in years."  
Go see it just for the halibut

**CO-OPERIVE ELEVATOR WINTER RAT PROTECTION SPECIAL!!**

**The most frightening thing about seeing a rat is not knowing how many you haven't seen!**

For every rat you see, there's no telling how many are in hiding. Waiting to do their dirty work. You can rest assured the rats you see and the ones you haven't seen can't stand up to the strengths of ASSAULT.

Side by side with grain, feed or competitive baits, rats and mice die for the taste of ASSAULT. Best of all, ASSAULT is powerful enough to kill nearly 100% of your rats and mice. Even ones that are known to be resistant to anticoagulant baits.

**ASSAULT A WEAPON WITH ENOUGH STRONG POINTS TO DESTROY THE ENEMY.**

**Purina Mills, Inc.**  
P.O. Box 66812  
St. Louis, MO 63166

**ASSAULT**

**FREE Cap With Each Pail Purchased!**

Assault is available at Pigeon, Gagetown, Akron and Sebewaing. Not available in Elkton. Offer good while supply lasts. Be sure to stop in and get the protection your barn, homes, sheds and storage facilities need against rat invasion!

**Cooperative Elevator Company**

AKRON 691-5711 ELKTON 375-2288 PIGEON 453-3313 SEBEWAING 883-3030 GAGETOWN 665-9975 TOLL FREE NO. 1-800-322-0601



# Singers attend regionals

Two local members of the Lake Huron Chorus of Sweet Adelines, Inc., were among the chorus members who attended the Fall Regional, held Oct. 28, 29 and 30 at the Airport Hilton in Romulus.

Beverly Haughton of Cass City and Carol Beitz of Gageton joined their fellow chorus members for the weekend, which featured various singing competitions and training sessions. The Lake Huron Chorus of Sweet Adelines invites any interested ladies who like to sing to join them on any Monday evening, from 7 to 9:30 p.m., at the cafeteria of the Huron Medical Care Facility on M-53 in Bad Axe.

Additional information about the group is available by calling Marian Rathje at 453-2524, or Peggy Hartman at 453-3714.

# Holbrook Area News

Mrs. Thelma Jackson  
Phone 658-2347

## TRIP

Mr. and Mrs. Jack Pelton left Metro Airport in Detroit Oct. 11 for London where they met their daughter and husband, Dr. and Mrs. John Zauner of San Francisco, Calif., and spent 3 days sightseeing and shopping before they flew to Nairobi, Kenya, East Africa. They joined the Ames Traveling Agency and took a 2,500-mile, 8-day safari which consisted of 7 mini buses and 40 tourists. Mostly doctors and their wives.

When they left the group, they flew back to London where they spent one night before leaving for their homes. Dr. and Mrs. Zauner left for San Francisco and Mr. and Mrs. Pelton returned to Metro Airport where they were met by Mr. and Mrs. Bill Goreski and

family Sunday afternoon. Mr. and Mrs. Pelton were overnight guests of Mr. and Mrs. Goreski and family at St. Clair Shores and returned home Monday.

Sister Carmella, Theresa Skipinski and Gladys Briolat of Ubyly, Mr. and Mrs. Clem Briolat, Mr. and Mrs. Jack Harbec of Cass City, Mrs. Harmon Nicol and Mr. and Mrs. Cliff Jackson attended the Marlene and Jack Wallace Adult Foster Care Home open house Sunday.

Mr. and Mrs. Gerald Wills were Saturday guests of Mr. and Mrs. Bob Church and Mr. and Mrs. Glen LePla at Crosswell.

Mr. and Mrs. Arnold LaPeer were Wednesday afternoon guests of Mr. and Mrs. Ronnie Gracey in Bad Axe.

Mr. and Mrs. Stuart Merchant of Cass City and Mrs. Carol Ann Hart of Bad Axe were Thursday evening guests of Mr. and Mrs. Jack Krug.

Annie McIntosh and Carlene McIntosh of Sterling Heights were Sunday guests of Mr. and Mrs. Martin Sweeney.

Brenda Tyrrell of Bay City spent the weekend with Kathryn Tyrrell. Reva Silver visited Mr. and Mrs. Harold Ballagh Saturday.

Recent guests of Mr. and Mrs. Allen Farrelly were Mr. and Mrs. Joe Campbell and granddaughter of Utica and Valerie Terwiliger and son Rodney of Bad Axe.

Mr. and Mrs. Cliff Jackson visited Mr. and Mrs. Elmer Fuester Friday afternoon.

Mr. and Mrs. Bernard Shagena of Sebewaing were Thursday evening guests of Mr. and Mrs. Glen Shagena.

Rose Czarniecki of East Detroit and Mrs. Evans Gibbard visited Eugene Otulakowski, Lillian Otulakowski and Stella Leszczynski Wednesday.

A.J. Baie and Brent Jackson were Wednesday evening guests of Mrs. George Jackson and Don.

Jim Hewitt visited Leslie Hewitt in Bad Axe Sunday.

Edanna Sweeney visited Reva Silver Tuesday forenoon.

Mr. and Mrs. Bill Cleland and family of Waterford were Saturday and Sunday guests of Mrs. Alex Cleland and Carol Laming. Saturday guests were Mr. and Mrs. Bob Cleland Jr.

Mr. and Mrs. Glen Shagena visited Bill Mason and Ora Hartell in Port Huron Monday forenoon and Leila Sills in the afternoon at Port Huron.

Mr. and Mrs. Orville Glaza and Mr. and Mrs. Stanley Glaza spent Monday and Tuesday at their cottage at Lewiston.

Reva Silver was a Thursday evening guest of Beverly Rockefeller and a Friday afternoon guest of Mr. and Mrs. Fay McComb in Cass City.

Patsy Recor was a Saturday lunch guest of Mr. and Mrs. Jim Doerr and Jeff.

Mrs. Allen Farrelly entered St. Luke's Hospital in Saginaw Sunday afternoon.

Theresa Skipinski, Sister Carmella and Gladys Briolat of Ubyly were Sunday afternoon guests of Mr. and Mrs. Clem Briolat in Cass City.

Mr. and Mrs. Ed Sharrow of Bad Axe and Mr. and Mrs. Cliff Jackson visited Mr. and Mrs. Ward Bonkelman Sunday afternoon.

Kathy Martinez was a Friday afternoon guest of Mrs. George Jackson.

Mr. and Mrs. Bill Bredow of Bad Axe and Jim Hewitt attended the funeral of Bill Bredow's uncle, Bill Bredow at the Will and Schwarzkoff Funeral Home at 1 o'clock Wednesday in Mt. Clemens.

Mary Sweeney spent a week visiting Mr. and Mrs. John Bodis and family and Mr. and Mrs. Bill Sweeney at Oscoda.

Bob Cleland Sr. and Jan McLure of Waterford were Friday overnight and Saturday guests of Mrs. Alex and Carol Laming.

Mr. and Mrs. Glen Shagena visited Mrs. Clayton Wheeler at Sandusky Hospital Sunday.

Mr. and Mrs. Stanley Glaza visited Jack Krug at Huron Memorial Hospital in 3rd Ave Friday.

Audrey Katzenberger, Elizabeth Stine, Mary

Kirton, Clara Seeley and Velma Cleland served donuts and cider at Provincial House for Halloween Monday, donated by the Art Club of Cass City.

Mr. and Mrs. Dennis Bartle and Tommy of Cass City were Friday evening guests of Mr. and Mrs. Allen Farrelly.

Mr. and Mrs. Gaylord LaPeer of Cass City were Wednesday supper and evening guests of Mr. and Mrs. Cliff Jackson.

John Naples and a friend and son from East Detroit spent Saturday with Mrs. Louis Naptes.

Rose Czarniecki of East Detroit spent Tuesday and Wednesday with Mr. and Mrs. Evans Gibbard.

Melissa and Jim Jackson were Sunday afternoon guests of Mrs. George Jackson and Don.

Crystal, Jennifer, Brandon and Joshua Schultz of Bad Axe and Lori Schultz and Shannon went trick or treating in Bad Axe Monday evening.

Visitors at the home of Edanna Sweeney and David last week were Laura Blett, Mrs. Earl Schenk, Joe Sweeney, Tom O'Henley and Bill Sweeney.

Mr. and Mrs. Ken Osen-toski were Sunday afternoon guests of Mrs. Alex Cleland and Carol Laming.

Bertha Shagena was a Sunday afternoon guest of

## Wednesday is...

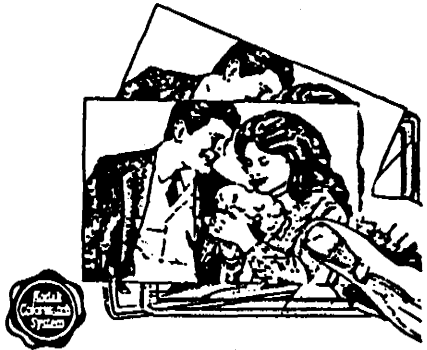

**DOUBLE PRINT  
DOUBLE VALUE DAY!**  
Every Wednesday receive a second set of prints absolutely FREE!

"Check Our New Lower Photo Processing Prices."  
Offer good during Wednesday normal business hours  
NEXT DAY or FREE VOID on Double Prints.

**COACH LIGHT PHARMACY**  
MIKE WEAVER, Owner Ph 872-3613  
Emergency Ph 872-3283  
Your Family Discount Drug Store

## MARY MARK

# AUCTION SALE

**REAL ESTATE HOUSEHOLD**

As I am unable to care for my home any longer, I will sell the following items at public auction located 4 blocks east of stoplight in Cass City, 3 1/2 blocks south at 4314 Ale Street.

**SATURDAY, NOV. 12 AT 11 A.M.**

### REAL ESTATE AUCTION 3 P.M.

The following described Real Estate will be offered for sale at PUBLIC AUCTION at approximately 3:00 p.m., Saturday, November 12 on the premises located at 4314 Ale Street, Cass City, Michigan.



Legal Description: Commencing 2 rods South of Southwest corner of Lot one of Block four of Ale's Addition to the Village of Cass City; thence South 8 rods, thence East 8 rods, thence North 8 rods, thence West 8 rods to place of beginning. Both lots are side by side with curb and gutter. Both lots have nice shade and Evergreen trees of different types. 1 1/2 story pressed Brick home with approved roof. Partial insulated basement with recently installed HELL forced air furnace with duct work and natural gas. Insulated electric hot water heater. Water hook up. 100 amp circuit breaker with approved wiring. Lots of storage area. Main floor consisting of two bedrooms with large closets. Spacious living room with wall to wall carpeting. Large hallway with beautiful built-in China Cabinet and desk. Full bath. Kitchen-Dinette area with many custom built Birch Cabinets. Garbage disposal and much more. Small rear room for deep freeze, etc. Walk up attic with dormer and lots of storage area. 1 1/2 car garage with overhead door.

TERMS: 10% security deposit on day of sale, balance due and payable within 30 days after delivery of Marketable Title. Possession and Real Estate taxes to be prorated to date of closing. For showing call 517-872-2966.

### HOUSEHOLD & MISCELLANEOUS

- Whirlpool refrigerator w/top freezer
- Chill Chest small, chest-type freezer
- Admiral color TV - Wood desk, nice
- 2 twin beds complete, nice
- Double bed complete - Bedside table
- Dresser & mirror - Large chest of drawers
- Bennett upright piano & bench in good condition
- Wood drop leaf table & 4 matching chairs
- Buffet - Green couch - Green recliner
- Swivel chair - Occasional chair
- Foot stool - Step end table - Small stand
- Chrome kitchen table with 2 chairs
- Card table - Humidifier - Elec. heater
- 2 Pressure cookers - Toaster
- Lamps - Floor lamps - Vacuum sweeper
- Royal typewriter, portable - Suitcases
- Ironing board - Lawn furniture

- Fishing box & equipment - Fishing poles
- Silverware - Dishes - Knickknacks
- Set of dishes with 8 place settings
- Pots & pans - Hand tools
- Electric drill - Small stepladder
- Step ladders - 2 sets 16' extension ladders
- Shovels - Forks - Hatchets - Trimmers
- Rakes - Hoes - Garden hose
- Full length fur coat
- Bed spreads - Linens - Blankets - Towels
- Others

### ANTIQUES & COLLECTIBLES

- 8 Patch work quilts
- Ingraham mantel clock
- Kerosene lamp - Flat top trunk
- Roger Bros. silverware - Daffodil pattern
- Picture frames - Wood chairs - 2 stools
- Treadle sewing machine - Wood cupboard
- Small, oak cupboard - Baskets

- Dresser set - Small celluloid boxes
- Jewelry - Walman pocket watch
- Hooked rugs - Figurines - Knickknacks
- Fiesta bowls & plates
- Several pieces of pink & green Depression glass
- Norriatic dishes
- 6 etched cut tumblers
- 5 etched cut sherberts
- Clear glass berry bowl set - Several teapots
- Cups & saucers - Celery dish
- Footed bowl - Salt
- Mustache cup - "Forget Me Not"
- Nippon dishes - Plates - Hat
- Wood bench - Dishwasher
- 2 gal. crock - 6 gal. crock - other crocks
- Copper boiler - Fruit jars
- Old & new sheet music - Tin with buttons
- Straight razor and strap
- Farm Produce dust pan
- Farm Produce level
- Others

LUNCH AVAILABLE

CLERK: Hillaker Auction Service  
TERMS: Cash or check with ID. Everything settled for day of sale. Not responsible for accidents.

**MARY MARK, OWNER** POWER OF ATTORNEY LOIS ARTHUR  
AUCTIONEERS - HILLAKER AUCTION SERVICE  
Phone 517-872-3019 or 517-872-5375 Cass City, MI.

## Air Force promotes E.A Bush

Elizabeth A. Bush, daughter of Kenneth R. and Joan E. Pierce, 6093 State St., Kingston, has been promoted in the U.S. Air Force to the rank of staff sergeant.

Bush, a 1980 Kingston High School graduate, is a passenger and household goods specialist with the 513th Transportation Squadron in England.



Elizabeth A. Bush

Her husband, Sgt. Bradford L. Bush, is the son of Dinah Argo of Devine, Texas.

Bush's parents are planning to make an early December trip to England to visit the couple, who are expecting their first child.

# Sale

## WARNER WALLPAPER

### 30% OFF

*Limited Time Only*

6344 MAIN ST. - CASS CITY 872-2445

the **PAINT STORE**

# HERE'S PROOF WE SELL FOR LESS!

**ONE A DAY**  
Essential  
100 TABLETS  
VITAMIN PROTECTION

100 Tablets  
**\$4.77**  
\$7.00 Value

**30 FREE**  
Senior Multi-Vitamins  
**\$7.59**  
120 tabs  
Reg. \$9.19

**Centrum**  
30 TABLETS WITH 100 VITAMINS

130 Tablets  
Discount Price **\$8.97**

**30 FREE**  
Multi-Vitamins  
**\$7.42**  
120 ct.  
Regular \$10.05

**GERITOL COMPLETE**  
100 Tablets  
**\$10.93**  
Discount Price

**Myadec**  
100 30  
High Potency Tablets

130 Tablets  
Discount Price **\$11.99**  
Regular Value \$14.37

### MONEY ORDERS 35¢

1000's of  
**CD RECORDINGS**  
In Stock

Pay Your **THUMB ELECTRIC** Bill Here

We accept all **Pre-Pay Prescription Plans**

Drop Off - Pick-up **STATION For GENERAL TELEPHONE**

Thumb Distributor **HOLLISTER OSTOMY PRODUCTS**

# COACH LIGHT PHARMACY

MIKE WEAVER, Owner Ph. 872-3613  
Emergency Ph. 872-3283  
Your Family Discount Drug Store

Advertise It In  
The Chronicle



# Cass City Bowling Leagues

## MERCHANETTE LEAGUE Nov. 3, 1988

Cass City State Bank	31
Anrod Screen Cyl.	24
Konrad's Bakery	22
Caro Chiropractic	21
Croft-Clara Lumber	21
Clean Up Crew	21
Miller's Chicks	19
IGA Foodliner	18
Cass City Sports	17
Kelly & Co. Realty	13
Kritzman's	12

High Team Series: Cass City State Bank 2381.
High Team Game: Cass City State Bank 834.
500 Series: G. Corcoran 572, T. Mihaesi 536, P. Corcoran 529.
200 Games: G. Corcoran 211, P. Corcoran 204.

## MERCHANTS "A" Nov. 2, 1988

Cass City Oil & Gas	23
Paul's Urethane Syst.	22
Scott Chevy-Olds	20
Herron Builders	20
Kingston State Bank	20
New England Life	19
Charmont Motel	18
Brentwood	17
Kilbourn Tech. Supply	16
Charmont	14
Board Chrysler-Plymouth-Dodge	14
Croft-Clara Lumber	13

## MERCHANTS "B" Nov. 2, 1988

Charmont	4
Walbro	4
Cass Tavern	3

## MERCHANTS "A" Nov. 2, 1988

Bowling Busters	14
White Kittens	14
High Rollers	12
The King's Kids	12
Karate Kids	11
Speed Rollers	10
Go-Getters	9
The Rascals	9
The Slammers	7
Tigers	6
The Rad Rollers	2

## MERCHANTS "B" Nov. 2, 1988

Sharp Shooters	15
The Rollers	12 1/2
Wolverines	12

Cass City Sports	3
D & D Construction	1
Lucky Strikes	1
Miller Eggs, Inc.	1
Road Warriors	10 1/2
The Country Kids	10
The Dream Team	9
Starlights	9
Pin Pointers	6 1/2
The Hot Bowlers	2

## High Series: J. Zawilinski 611, R. Custard 586, M. Grifka 560.

## NIGHT OWLS Nov. 2, 1988

High Series: J. Schwartz 598, B. Kingsland 554.
High Games: J. Schwartz 221-214.
High Team Series: Pros 1565.
High Team Game: Pros 545.

## FRIDAY NIGHT MIXED DOUBLES Nov. 4, 1988

The Family	46
Terra	45
Dream Team	44 1/2
Team #4	41
#Ones	39
Magnetek Control	38
Cass City VFW	37 1/2
The Restless Ones	37
Bee Gee's	28
Hell Raisers	22
Friday Night Hopefuls	21
Bye	21

Men's High Series: F. Soldan 540, C. Walsh 531.
Men's High Games: L. Tracy 203, F. Soldan 202.
Women's High Series: C. Haley 494, J. Davidson 469.
Women's High Games: C. Haley 197, J. Davidson 177.
High Team Series: Magnetek Control 1896.
High Team Game: Magnetek Control 668.

## SATURDAY SPINNERS "A" Jr. League Nov. 5, 1988

Miller Eggs	43
Blue Water Harvester	42
Martin Electric	38
Brinkman	38
D & F Signs	34
Kermit	33
Vanderpoel	28
Charmont	26

## TUSCOLA GET TOGETHERS "A"

Men's High Series: G. Peruski 182.
Boy's High Game: T. Herringshaw 100.
Girl's High Series: H. Zawilinski 141.
Girl's High Game: H. Zawilinski 102.
High Team Series: High Rollers 417.
High Team Game: High Rollers 242.

## SATURDAY SPINNERS "B" Sr. League Nov. 5, 1988

Men's High Series: G. Jackson 666, D. Niebauer 594, K. Martin 577.
Men's High Games: G. Jackson 246-222, K. Martin 239, C. Comment 220, D. Niebauer 212.
Women's High Series: S. Matthews 556, B. Schott 543.
Women's High Games: S. Matthews 223.
High Team Series: Schott's Accounting 2012.
High Team Game: Re Racks 714.

LaFave	16
Estech	15
B.A. Calka	15
Doakers Pro Shop	8

## High Series: T. Comment 628, M. Diegel 597, D. O'Dell 619, R. Hood 593, D. Miller 625.

High Games: D. Miller & D. O'Dell 235, M. Diegel 212, T. Comment 217-222, N. Holdburg 222, L. Tracy 213, D. Miller 211-235, R. Hood 224, B. Anthes 211.
High Team Series: Miller Eggs 2804.
High Team Game: Miller Eggs 957.

## CHARMONT LADIES

Truemner Salvage	25
Veronica's	23
Cable-ettes	22
Charmont	22
Live Wires	21
Cass City State Bank	19
Anthony's Pty. Shoppe	16 1/2
Thumb Nat'l Bank	16
Pizza Villa	15 1/2
Colony House	15
Cass City ServiStar	12
Board Chrysler-Plymouth-Dodge	9

## High Series: B. McLachlan 614, D. O'Dell 593, B. Rudich 582.

High Games: P. Corcoran 211, T. Deiks 208, B. Kilbourn 201, H. Peters 179, B. Phillips 180, D. Dunham 178, S. Badder 177, H. Karr 186, D. Sweeney 183, L. Yost 181, E. Butler 172, E. Romain 178, M. Truemner 193, J. LaRoche 180.
High Team Series: Anthony's Party Shoppe 1050.
High Team Game: Anthony's Party Shoppe 2880.
High Series: P. Corcoran 563, B. Kilbourn 521, M. Truemner 494, B. Phillips 492, J. Lapp 498, E. Romain 494.

## HOLY ROLLERS Oct. 23, 1988

Sandbaggers	18
Sugar Makers	14
Re Racks	13
Schott's Accounting	12
The X's	12
Auctioneers	12
The Four Seasons	10
Moose's Folly	9
Ready Freddie's	8
Dave Hall Inc.	4
Easy Does It	3
M & G's	1

Men's High Series: G. Jackson 666, D. Niebauer 594, K. Martin 577.
Men's High Games: G. Jackson 246-222, K. Martin 239, C. Comment 220, D. Niebauer 212.
Women's High Series: S. Matthews 556, B. Schott 543.
Women's High Games: S. Matthews 223.
High Team Series: Schott's Accounting 2012.
High Team Game: Re Racks 714.

Men's High Series: K. Kilbourn 577, L. Sweeney 568.
Men's High Games: L. Sweeney 257.
Women's High Series: E. Romain 466.
Women's High Game: E. Romain 178.
High Team Series: Woodchoppers 1946.
High Team Game: Woodchoppers 746.

Anthony's Pty. Store	26
Jacques Seeds	24
Croft-Clara	24
Northon Const.	21 1/2
Kilbourn Service	20 1/2
Quaker Maid	20
Spaulding Bldg.	20
Nelesco	20
Rolling Hills	19
Cass City IGA	17
Scott Chevy-Olds	16
Kilbourn Tech	12

## THURSDAY NITE TRIO Nov. 3, 1988

High Series: B. McLachlan 614, D. O'Dell 593, B. Rudich 582.
High Games: B. McLachlan 224-217, D. O'Dell 210, P. Regnerus 219, D. Englehart 213, K. Schott 214, R. Nicholas 210.
High Team Series: Scott Chevy-Olds 1847.
High Team Game: Scott Chevy-Olds 664.

## SUNDAY DIRTY DOZEN Oct. 30, 1988

Ks & Zs	15
Deford Country Groc.	14 1/2
Woodchoppers	13
Go-4-It	13
Don Eral Foods	11
Mad Crashers	11
Good-Guys & Tim	9
No Problem	8
Team Chaos	7
Back-Street Tanning	5 1/2
Poor Excuses	5
4-Fun	0

## SUNDAY NIGHTERS Oct. 30, 1988

High Rollers	13
Schott's Accounting	13
Misfits	12
Talaski Trucking	10
Scuba Doo's	9
Try Hards	8
Family Feud	7
The Sweet Guys	7
Pat Curtis Chevrolet	6
Town & Country	6
The L.T.'s	3

Men's High Series: K. Schott 573.
Men's High Game: E. Hutchinson 213.
Women's High Series: S. Lobdell 497.
Women's High Game: C. Voss 194.
High Team Series: Schott's Accounting 1865.
High Team Game: Family Feud 662.

# RED HAWK STUDENT OF THE WEEK

Presented by the Cass City High School Student Council



Senior Brent Beecher son of Keith & JoNell Beecher

Chosen student of the week for being honored by the First National Bank of Bad Axe as athlete of the week.

Courtesy of Board Chrysler/Plymouth/Dodge "Your Downtown Dealer"

## FRESH STUFF!

74 CHARGER "SE"-A Classic Muscle Car!	Asking \$1995
81 FORD FAIRMONT 4 Dr. - Automatic	Asking \$1995
84 Renault ALLIANCE 4 Dr. - Auto/Air	Asking \$3995
86 ESCORT "L" 2Dr. - One owner/Cass City	Asking \$4995
84 FIREBIRD "SE" - One owner/Loaded!	Asking \$5995
87 DODGE 600 "SE" - Loaded/New Tires	Asking \$5995
86 RELIANT "SE" 4 Dr. - Auto/Air	Asking \$6995
84 RAM 150 "Conversion Van" - 47,000 miles	Asking \$6995
85 OLDS CALAIS 2 Dr. - V-6/Auto/Loaded!	Asking \$7995
88 RELIANT "LE" 4 Dr. - Air/Auto/10,000 miles	Asking \$8495
85 OLDS DELTA "88"ROYALE - V-8/38,000 miles	Asking \$8995
85 GRAND MARQUIS "LS" 4 Dr. - V-8/Loaded!	Asking \$8995
86 VOYAGER "SE" 7 Passenger/Air/37,000 miles	Asking \$8995
88 DAYTONA H/B - Auto/Air/7,000 miles	Asking \$9995
88 DAKOTA Longbox P.U. - 10,000miles/V-6/Auto	Asking \$9995
87 D-150 Longbox P.U. - 2 tone/V-8/Auto	Asking \$9995

WINTER SALES HOURS: Mon. thru Fri. 8:30 to 6, Sat. 9 to 2  
SERVICE & PARTS: Mon. thru Fri. 7:30 to 5:30, Sat. 8 to noon



**BOARD**  
DOWNTOWN CASS CITY  
New Car Showroom • 872-2184 Used Cars • 872-5020  
or TOLL FREE - "THE CALL'S ON ME!"  
**1-800-622-1312**

## Academy honor roll released

Deford Christian Academy officials recently announced their honor roll for the first marking period. Students named to the roll are:

### 4 YEAR OLDS - KINDERGARTEN/1ST

#### HONOR ROLL "A"

Debbie Baughman, Monica Dorland, Sally Lockwood, Sherry Luana, Kristyn Struve, Michael Yax, Michelle Yax.

#### ELEMENTARY

#### HONOR ROLL "A"

Aaron Allen, Melannic Allen, Adam Barriger, Faith Barriger, Bethany Baughman, Crystal Collins, Matt Colwell, Carrie Cybulski, Charity Hull, Jeff Kilbourn, Toby Kilbourn, James Kilburn, Ruth Kilburn, Jeremy Lockwood, Amanda Monte, Leah Monte, Angela Sanford, Laura Sanford, Jim Sattelberg, Bethany Strait, Jared Thane, Ryan Willis.

#### HONOR ROLL "B"

Rebecca Dawson, Trent Dorland, Jeri Lynn Linderman, Amy Luana, Michelle Reeves, Carletta Sattelberg.

#### JUNIOR HIGH

#### HONOR ROLL "A"

Sam Barriger, Kelly Colwell, Mindy Cybulski, Mark Kilburn, Christina Reeves, Ben Strait.

#### HONOR ROLL "B"

Cindy Collins, Susan Graham, Shana Heckroth, Ted Linderman, Matt Mozdgen, Lisa Ollila, Amy Rodgers, Stacey Thane, Andrea Venema.

#### SENIOR HIGH

#### HONOR ROLL "A"

Cheryl Collins.

#### HONOR ROLL "B"

Grace Barriger, Perry Graham, Sunday Kennedy, Jim Thane.

## Supper set at Deford

The Deford Community Church will hold its annual harvest and hunter's supper from 5 to 8 p.m. Nov. 15 at the church, 1392 Kingston Rd., Deford. Cost will be a donation to the DCA Booster Club for Spring Youth Convention expenses.

## Bowler of the week

The Thumb Area Women's Bowling Association Bowler of the Week for Oct. 16-22 is Elaine Romain, with a 559 actual series. She bowls for the team of Veronica's on the Tuesday Night Charmont Ladies' League at Charmont Lanes, Cass City. Other 550 and higher series bowled were: Kathy Shedd, 554, Blue Water Lanes, Harbor Beach; Eileen Ingles, 552, Blue Water Lanes, Harbor Beach, and Florence Penfold, 551, Biff's, Kinde.

**Free! Jewelry Case** with purchase! (\$25 retail value)

Buy any Jewelmont family ring and we'll give you this decorative, hand carved, Italian-made Alabaster jewelry case, **ABSOLUTELY FREE!** till Dec. 15th

Plan to order soon for Christmas.

**McConkey** JEWELRY AND GIFT SHOP  
Phone 872-3025 Cass City

## Your neighbor says Hardee's will do well in Cass City

Cass City's first fast food establishment opened its doors last week and response, according to Hardee's officials, has been more than favorable.

Hardee's, which plans to start its next outlet in Seline, Mich., adds only about 5 new stores per year. The third largest hamburger chain restaurant is headquartered in Rocky Mountain, N.C., and has more than 3,000 restaurants across the nation.

The City State store hopes to become an active member in the business sector of the village, and your neighbor, Dean Hoag, believes they will.

Hoag, a 27-year employee of General Cable corporation, was prompted with the question, "Will any other fast food chain follow Hardee's lead and come to Cass City?"

"I think that depends on our industry. If we can attract another factory or corporation to come into our industrial park, I don't see why not," said Hoag.

The Deckerville road resident also feels that the restaurant will do well during the high school basketball season. "It will give kids a place to go after the games and parents a place to stop before the game if they're rushed for time," commented the father of 5.

And has Dean visited the restaurant? "Twice. Once for breakfast, once for lunch. Satisfied both times," the mild mannered manager concluded.

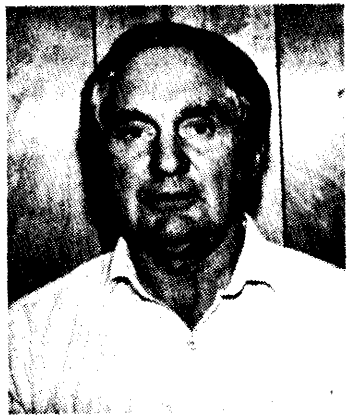

## Others Get Quick Results With The Chronicle's Classified Ads— You Will Too!

### FAMILY FELLOWSHIP COMMUNITY

### "FREE TO ALL" THANKSGIVING DINNER

### THANKSGIVING DAY NOV. 24 - starting at 1:00 p.m.

### at CASS CITY'S SAINT PANCRATIUS CHURCH

Sit-down Dinner at 1 p.m. Call 872-4269 for transportation if necessary. Take-out dinners available at 3 p.m. Delivery only on request.

FOR DINNER RESERVATIONS CALL  
872-4604 872-3336  
872-3422 872-5060

Thanks For This Advertisement to  
**CASS CITY STATE BANK**

## THANK YOU

Wesley and Nancy would like to express our appreciation for your patronage during our Grand Opening. We would like you to come in and enjoy our unique homestyle foods.

Remember...

When your appetite craves home cooking CA-NAN'S is the place to eat. Home baked Bread, Rolls, Cinnamon Rolls, Pies and Homemade Soups are our Specialty.

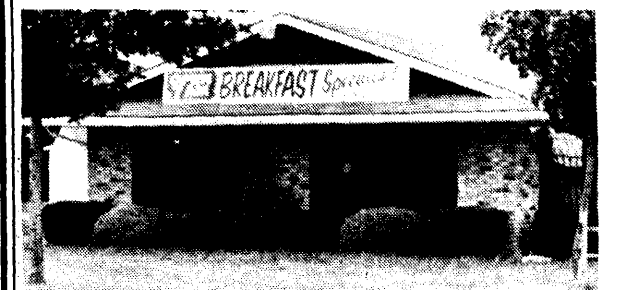

Call us 872-5333 We Deliver

### DEER HUNTER'S SPECIAL

TUESDAY, NOV. 15, 4:30 A.M. - 9 A.M.

2 Eggs, Hash Browns, Toast, Coffee **\$1.35**

Every Sunday Special Ham & Yams **\$3.95**

Friday evening Specials All you can eat Fish Shrimp & Scallops **\$4.95 \$5.95**

872-5333

**CA-NAN'S RESTAURANT**  
4515 Nestle

HOURS — 7-9 Weekdays & Sun.; 7-10 Fri. & Sat.



**Sr. Citizens Menu**

Senior citizens are asked to make reservations on the day of the meal between 8 a.m.-9 a.m. by calling Ann Stepka 872-5337.

**MONDAY, NOV. 14**

- Oven Fried Chicken
- Mashed Potatoes
- Salad Bar
- Variety Bread
- Jell-o w/Fruit

**WEDNESDAY, NOV. 16**

- Boiled Dinner w/Pork
- Carrots, Onions, Cabbage
- Green Beans
- Variety Bread
- Pineapple Tidbits

**FRIDAY, NOV. 18**

- Turkey Rice Loaf
- Au Gratin Potatoes
- Squash
- Variety Bread
- Orange
- Coffee, tea and milk provided with each meal. (Menu subject to change).

**Obituaries**

**Josephine Ardler**

Mrs. Josephine K. (Jo) Ardler, 61, of Goldsboro, N.C., formerly Cass City, died Oct. 24 in Omaha, Neb. She was born Jan. 1, 1927, in Englewood, N.J. She is survived by her husband, Hank Ardler of Goldsboro, former plant manager at General Cable in Cass City; 2 daughters, Mrs. Jerry (Debbie) Friedrichsen of Omaha and Mrs. Gary (Kathy) Edmunds of Davenport, Iowa; 3 granddaughters, 3 grandsons, 2 sisters, Mrs. Lulian Henriques of Ridgewood, N.J., and Mrs. Adele Cordaro, Teaneck, N.J., and several nieces and nephews. Mrs. Ardler was employed at The Pinney State Bank for 15 years and was a member of St. Pancratius Catholic Church of Cass City.

Funeral services were held Friday, Oct. 28, at St. Paul the Apostle Catholic Church. Interment was in Davenport Memorial Park.

**Patrick Bliss**

Patrick Robert Bliss, infant son of David and Cinzia (Armand) Bliss of Cass City, died Thursday, Nov. 3, at William Beaumont Hospital in Royal Oak. He was born May 18, 1988, in Royal Oak. His twin brother, Preston, died at birth. Other survivors include his paternal grandparents, William and Marjorie Bliss of Cass City; maternal grandmother, Mrs. Theresa Armand, and maternal great-grandmother, Mrs. Louise Armand, both of Warren, and a number of aunts and uncles. Funeral services were conducted Saturday at 5:30 p.m. at Little's Funeral Home, Cass City, with Father Julius Spleet, pastor of St. Pancratius Catholic Church of Cass City, officiating. Burial was in Elkland Cemetery.

**James Botka**

James Botka, 72, of Owendale, died Thursday, Nov. 3, at Huron Memorial Hospital, Bad Axe, after a long illness. He was born Dec. 11, 1915, in Cleveland, Ohio, son of Frank Sr. and Mary (Lasinger) Botka. He married Roza Hajlitusz Aug. 26, 1950, in Toronto, Ont. He farmed in the Owendale area until his retirement, was a member of the Hungarian American Aid Society, Vassar, and the Owendale Lions Club. Surviving are his wife; one daughter, Deborah Tarmey, Ypsilanti; one son, Paul Botka, Gageton; 3 grandchildren; a sister, Mrs. William (Christine) Kole, Holiday, Fla., and several nieces and nephews. He was preceded in death by 2 brothers, Adam and Frank Jr. Services were held at Shetler-Bussema Funeral Home, Pigeon. Burial was in Grant Township Cemetery.

**Agnes Gordon**

Agnes Coultts Gordon, 85, formerly of Decker, succumbed Oct. 28 in Roney Manor Nursing Home, Dearborn Heights. She was born Sept. 12, 1903, in Buchlyvic, Scot-

land, and emigrated to Montreal, Canada, in 1924. Dec. 8, 1928, she married William Gordon of Detroit, who preceded her in death on their 41st wedding anniversary, Dec. 8, 1969. She is survived by 4 children, William T. Gordon of Grafton, Ohio, Elizabeth Nauka of Union Lake, Violet Wills of Cass City and Jane Baxter of Trenton; 6 grandchildren, and 8 great-grandchildren. One grandson preceded her in death. Services were held Oct. 31 at Orchard Lake Community Church-Presbyterian. Interment was in the family plot at Forestlawn Cemetery, Detroit.

**Geraldine Hendricks**

Geraldine E. Hendricks, 64, Hume Township, died Tuesday, Nov. 1, at Huron Medical Facility, Bad Axe, after a long illness. Mrs. Hendricks was born in Morgantown, W.Va., April 17, 1924, daughter of Hazel Valentine and the late Chester Harding. She married Charles Hendricks April 9, 1950, in Cumberland, Md. They resided in Huntington Woods until January 1976, when they moved to the Port Austin area. Her husband preceded her in death Jan. 28, 1986. She was a member of the United Protestant Church, Port Austin. Surviving are 2 stepdaughters, Vivienne Sperling, Davison, and Barbara Olmstead, Stevensville; one stepson, Dana C. Hendricks, Highland Park; her mother, Hazel Valentine, LaVale, Md.; 2 sisters, Helen Myers, Baltimore, Md., and Mrs. Joseph (Janet) Church, Palm Coast, Fla., and one brother, John Richard Valentine, Mexico Farms, Md. Services were held Friday at the United Protestant Church, with the Rev. Robert Garrett officiating. Burial was in the Acacia Park Cemetery, Birmingham.

**Harley L. Kelley**

Funeral services were held last week for former Cass City resident Harley L. Kelley of Fort Wayne, Ind., who died Oct. 30 at his residence. He was 82. Kelley was born in Cass City, the son of William W. and Clara M. (Hunt) Kelley. A retired dairy farmer and construction worker, he attended Taylor Chapel United Methodist Church, Fort Wayne. He also was a former member of the Deford United Methodist Church, Deford. Kelley is survived by his wife, L. Elna Kelley of Fort Wayne; 3 sons, Dr. Arleon Kelley of Albany, N.Y., Bernard Kelley of Fort Wayne and William Kelley of Indianapolis, Ind.; one daughter, Marjorie Bowser of LaOtto, Ind.; 2 sisters, Freda Wagg of Cass City and Ruby Evans of Gageton; and 7 grandchildren and 2 great-grandchildren. Funeral services were held Nov. 2 at D.O. McComb & Sons Maplewood Park Funeral Home, Fort Wayne, and Nov. 3 at Deford United Methodist Church. Burial was in Novesta Township Cemetery. Memorials can be made to the New Hymnal Fund at Taylor Chapel United Methodist Church.

**Joseph Klein**

Joseph F. "Jack" Klein, 73, died Sunday, Oct. 30, in the Evangelical Home of Port Huron. He was born March 29, 1915, in Royal Oak. He had been a resident of Port Huron since 1953 and was a former resident of Cass City. He married Mildred M. Schwegler Feb. 9, 1942, in Bowling Green, Ohio. She died April 8, 1976. He owned and operated Klein's Bottled Gas Service until 1963. He is survived by 2 daughters, Mary P. Klein of Marysville and Mrs. Fern L. Hyslop of St. Clair; 4 sons, Jack F. of Gettysburg, Pa., James W. of Lake Wales, Fla., Robert A. and Andrew J. of Port Huron; a sister, Mrs.

**In circuit court**

**Armed robbery plea nets 4 to 20 years**

One of 4 men accused of taking part in the Feb. 28 armed robbery of a Cass City couple was sentenced to 4 to 20 years in prison Friday in Tuscola County Circuit Court.

Lonnie L. Jordan, 21, of Detroit, was sentenced for an Aug. 10 plea of guilty to armed robbery.

Jordan and Fernando Vega, 21, also of Detroit, were charged with holding Larry and Karen Wilding at gun point and ransacking the couple's upstairs apartment at 6359 Pine St. while searching for drugs and money.

In July, Vega pleaded guilty to armed robbery in circuit court. He also pleaded guilty, in U.S. District Court, Bay City, to using a firearm in a drug trafficking crime.

Charges are still pending against 2 other defendants, who police believe were waiting in a vehicle near the Wilding apartment during the robbery. The defendants are Anthony E. Nerkowski Jr., 23, of Dearborn, and Allen Zimmerman, 24, of Gageton.

In other proceedings Friday, Randall J. DuRussell, 34, 225 Ellis St., Caro, was sentenced for a plea of guilty Sept. 9 to breaking and entering an unoccupied dwelling.

DuRussell was sentenced to 1 year in the county jail, with credit for 188 days

served; 5 years probation, \$600 in costs and fines, and attorney fees. He also was ordered to receive counseling at Mental Health and to attend Alcoholics Anonymous meetings.

Court records state the charge against DuRussell stems from the May 1 break-in of the D & C Department Store in Caro.

Millington resident Gary C. Gipson, 27, 2075 Swaffer Rd., was sentenced to an additional 30 days probation and ordered to pay \$40 in restitution and a \$500 fine

for a plea of guilty to probation violation Oct. 27. Gipson was granted the right to participate in the work site program.

He violated his probation by using marijuana July 11, records state.

Also Friday, a motion to set aside the March 16, 1981, conviction of James E. Rader, 26, 1139 Cemetery Rd., Deford, was granted.

Rader was convicted on a charge of delivery of marijuana. He was sentenced to 3 years probation and 45 days in the county jail plus court costs and fines.

**GTE compiling 1989 directory**

GTE is compiling information for its 1989 telephone directory.

According to Kevin Hammer, GTE Davison district manager, making a directory listing change is one simple phone call away. GTE customers who are living in the Caseville, Cass City, Elkton or Kingston communities who want to make corrections or additions to the directory must contact the company's service office at 1-463-0210 before Nov. 11. Most

changes can be handled over the phone and usually don't require a personal visit to the office.

Prior to that date, both residential and business customers can change their listings. Customers should be aware, however, that they may be charged a nominal "records change" fee for revisions made to white page listings.

Publication and distribution dates for the new directory will be announced later, Hammer said.

**TRI-COUNTY ANIMAL PRODUCTS, INC.**  
 Located at the intersection of M-53 and Bay City-Forestville Rds  
**Phone 517-872-4595**  
 Hours: Mon.-Fri. 9:00 a.m. to 4:00 p.m.  
 SPECIALS GOOD FROM NOV. 1 THRU NOV. 30 (while supply lasts)

	SPECIAL	REG.
Windvane Feeder	\$59.95	\$69.95
150 Gal. Rubbermaid Tank	89.95	99.95
Purina Rat Control Pellets	10.95	11.95
Hog Panels	13.95	15.95
Teat Shield w/ Germicide (in case lots)	15.99	17.49
Sulfamethazine 1#	10.49	11.49
Barn Scraper 18"	16.95	18.95
4 Tine Fork	15.95	17.95
Brake Fluid 12 oz.	.99	1.79
Galvanized Gate 2"x12"	80.98	90.98
8 Door Hog Feeder HF20P	185.95	199.95

**Special Tingley Boot Sale**  
 All size small 1300, 1400, 1500 reduced \$2.00  
 All size medium 1300, 1400, 1500 reduced \$1.00

**-Salt Nugget Special-**  
 50# bag @ \$3.49, in ton lots will deliver FREE with 1 week notice  
 Apollo Premium (2 piece ear tag system) buy 2 pks. @ \$16.99 ea.  
 GET an Apollo Applicator FREE (a \$11.95 value)

Good Quality Sawdust Available Now (Call for additional information)

**GLOVE SPECIAL** -Buy 12 pr. at regular Price -Get 2 pr. FREE!

**-TOW ROPES AVAILABLE-**

A Large Selection of Oil 79 cents per qt.

**Animal Vaccines Available**  
 Farmers Elevator - Minden City - (517)-864-3400  
 Peck Farmers Elevator - Peck - (313) 378-5986  
 Michigan Seeds & Supplies - Port Hope - (517) 428-4677 (Limited Quantity on Some Specials)

**SPECIALS AVAILABLE AT ALL THESE LOCATIONS**  
 Also Want To Purchase Bull Calves, May Be Medicated. For Additional Information Call Any Of The Above Locations

**HUNTERS**  
 Take advantage of our annual  
**BUCK POLE CONTEST**  
 Nov. 15-30  
 No pre-registration required.

1st place	Shoulder Mount
2nd place	50 Lottery tickets
3rd place	Travel-Bar
4th place	Beverage set
5th place	Case of Pepsi (1/2 liters)

**Additional Donated Prizes are**

1st Buck on pole	\$15.00 gas at Dave's Auto Service
1st 10 point on pole	\$10.00 of Jay's snack products
Match weight	- Deford Country sweatshirt
Lightest deer	- Deford Country sweatshirt
Heaviest deer	- Deford Country sweatshirt

Dave extends an invitation to all area hunters to stop in to an early morning Hunter's Breakfast starting at 4 a.m., Tues., Nov. 15 at Dave's Auto Service, located at 5816 Bruce St., Deford. Donations Welcome

**DEFORD COUNTRY GROCERY**  
 Beer-Wine-Packaged Liquor-Full Line of Groceries-Fresh Meats-Smoked Fish-Hardware-Automotive-Lottery-Sporting Goods-Hunting & Fishing License

5846 Bruce St.  
**DEFORD**  
 Ph. 872-3196



**Veteran's Day**

We're proud to honor all the men and women who took time out of their lives to serve in our armed forces, and especially all the Veterans in our area who are our friends, relatives, neighbors and customers. May we never overlook and always remember the important contribution they've made to America and Democracy.

**We will be closed Friday, Nov. 11 to Commemorate Veterans Day.**

**TN Thumb National Bank & Trust**



# Gagetown Area News

Gen Kehoe  
Phone 665-2221

Mrs. Elma Miklovich and Stella Leyva spent the day Oct. 23 in Bay City and had lunch at Pat's Place. Mrs. Miklovich had her granddaughter, Trisha Hawk, as a luncheon guest. The ladies visited Ciel Zuraw. Jackie and Bill Goodell spent last weekend with Mr. and Mrs. Henry Renzio of Livonia.

Helen and Harlan Stock attended the Bar Mitzvah for their grandson, Matthew Jaffe, Saturday, Oct. 30, in Ann Arbor. Other guests were Murl and Agatha LaFave, Mamie Russell, Betsy Dillon and

children, and Pam and Dick Reed. Matthew's parents are Penny and Victor Jaffe of Ann Arbor. After the party, Murl and Agatha LaFave went to Maumee, Ohio, where they spent the weekend with the Dennis LaFaves.

Owen-Gage Elementary students held their annual Halloween parade and party Monday. The Owen-Gage High School band played and students and teachers in costume made their ghoulish trek about town.

Mrs. Elma Miklovich spent Halloween weekend

in Port Huron with her sister, Ella Pattullo. Monday, she had lunch with her son, Ken Corey and family, and visited her brother and sister-in-law, Howard and Eleanor Kuhn, before they left to spend the winter in Bradenton, Fla.

Pauline Reehl and her father, Tom Wolschlagler, visited Mrs. Wolschlagler at St. Mary's Hospital in Saginaw.

attended the annual bazaar at Sacred Heart Parish in Caro Friday.

Harold Langlois is a patient at Huron Memorial Hospital, Bad Axe.

Mr. and Mrs. Elmer Adams left last week for their winter home at Peace River Hts., Fla.

Ethel Jamieson and Madelyn Haggitt of Wisner and Gerry Carolan spent the afternoon Sunday at the home of their cousin, Raymond Rabideau.

Willa and Wen Birch of Bay City hosted an open house Sunday in honor of the christening of their granddaughter, Katherine Lynn Birch. Parents are Mark and Diana Birch of Grand Rapids. Among the guests were Celeste and Mark Baranek and sons of Bay City and Harry and Gen Kehoe.

### EXTENSION MEETING

The Elmwood Extension held its November meeting Wednesday at 10:00 a.m. at the home of Gladys Laurie. In the absence of Chairman Florence Karr, Janet Martin conducted the business meeting. Ten members answered roll call with "Humor in Daily Life," and Helen Stock read the minutes of the last meeting. Brunch was served by the hostess and her co-hostess, Janet Martin.

The next meeting will be a Christmas luncheon Dec. 7 at 1:00 p.m. at the Char-mont in Cass City. There will be a \$3 gift exchange and roll call is a Christmas theme.

### Owen-Gage School menu

NOV. 14-18

MONDAY

Chili, Crackers  
Lunch Meat  
Salad Bar  
Dessert

TUESDAY

Turkey  
Mashed Potatoes  
Gravy  
Stuffing  
Salad Bar  
Pumpkin Squares

WEDNESDAY

Sloppy Joe  
Corn  
Salad Bar  
Fruit

THURSDAY

NO SCHOOL (Teacher  
County In Service)

FRIDAY

Tuna Noodle  
Green Beans  
Salad Bar  
Applesauce

Bread, butter, peanut butter, jelly, chocolate and white milk served daily. (Menu subject to change).

### FIVE YEARS AGO

The Orr home, more than 100 years old and one of the oldest in Cass City, was moved Friday to Elmwood Road, southeast of town. Gary and Margaret Czekai, who have six children, bought the house from the village for \$257. They hope to move in by winter. The village bought the house and property last year, now part of the village park.

Mrs. Robert Alexander went Sunday to Lake Orion to spend time with her daughter, Mrs. Grant Fry, and infant daughter.

More than 40 relatives gathered Sunday at the home of Mr. and Mrs. Clair Tuckey on Cass City Road for a potluck dinner and to celebrate their 61st wedding anniversary. Tuckey and Florence Wanner were married Nov. 6, 1922, at the home of her parents, the late Mr. and Mrs. Allen Wanner.

The monthly meeting of United Methodist Women of Trinity Church was held Monday evening at the church with 32 women present. Dinner preceded the business meeting, served by group No. 1, of which Mrs. Shirley Waggoner and Mrs. Marilyn Alexander were chairmen. Mrs. John Marshall presided over the business meeting and Mrs. Pauline Hulbert was in charge of the program.

### TEN YEARS AGO

Jeff Prieskorn, senior at Cass City High School, has been named to the Class C all-state first team in golf as selected by the Detroit News. The selection means Prieskorn is rated as one of the best 24 golfers in the state.

Boatswain Mate, Seaman Michael T. Gruber has been named non-rated sailor of the quarter on the USS Yosemite, a Navy tender ship that sails out of Mayport, Fla. He is the son of Mr. and Mrs. John Gruber of Cass City.

The Gagetown Village

# Down Memory Lane

From the files of the Chronicle

and second in the Shorthorn division of the annual sale held at Michigan State College Friday, Oct. 30.

Bay City Central High School announced this week that Art Paddy, former assistant in basketball and football at Central, has been

named head cage mentor at the school. Paddy began his career in Cass City.

The official Elkland Township Community Chest drive ended Saturday and President Wilma Fry reports that workers have collected approximately \$5,626 in this drive.

## your advertising dollars do better in the classifieds

**OPENING DAY**  
**Hunter's Breakfast Buffet**  
Tues. Nov. 15  
4:30 a.m.  
Wed. - Fri.  
opening 5:00 a.m.



Scrambled eggs, Bacon, Pancakes, Potatoes, Sausage gravy & Biscuits, Coffee **\$3.50**

Check out our **NEW LUNCHEON SPECIALS** every weekday 11 a.m. - 2 p.m. **only \$2.90** includes FREE DRINK



**Coupon** Any Large **PIZZAS** Taco Pizza also  
**\$1.00 Off**  
At Pizza Villa With This Coupon  
Expires 11-26-88  
One coupon per family—  
Not good with any other coupon.

**THE PIZZA VILLA**  
Open 6 a.m. to 9 p.m. Daily  
Fri. & Sat. Open 24 Hrs. Phone 872-4371 872-4440

# Professional and Business DIRECTORY

**ACCOUNTANTS**

**Anderson, Tuckey Bernhardt & Co., P.C.**  
Certified Public Accountants  
Gary Anderson, CPA - 872-3137  
Robert Tuckey, CPA - 872-3137  
Jerry Bernhardt, CPA - 872-3137  
715 E. Frank St., Caro, MI and  
6261 Church St. Cass City, MI  
Phone 872-4668

**Ray Armstead Jr.**  
Certified Public Accountant  
Office Hours: 9-5 Mon.-Fri., Sat 9-12. Other hours by Appointment  
6312 Main Street  
Cass City, MI 48726  
(517) 872-4532

**COUNSELING**

**DO YOU HAVE A DRINKING PROBLEM? ALCOHOLICS ANONYMOUS AND AL-ANON**  
Every Friday Evening - 8:00 p.m.  
Good Shepherd Lutheran Church  
Cass City

**DENTISTS**

**R. Paul Chappel, DDS, PC**  
Family Dentistry  
Comprehensive Orthodontics  
6240 Hill, Cass City  
Phone 872-3870

**HEALTH CARE**

**IMMEDIATE NON-EMERGENCY HEALTH CARE**  
**\$25 fee**  
Including physician's fee and clinic room.  
No Appointment Necessary  
8:00-8:30 p.m. Fridays  
2:30-8:30 p.m. Saturdays  
10:00 a.m. - 8:30 p.m. Sunday

**HILLS AND DALES HOSPITAL**

**HOME CARE**

**THUMB AREA HOME CARE AGENCY**  
Nursing: Speech Therapy  
Nurse Aides up to 24 hours.  
Medicare and Medicaid certified.  
Blue Cross  
Your locally owned, private non-profit, full service Home Care Agency.  
(517) 474-8746  
1 (800) 358-4749

**INSURANCE**

**Allen Witherspoon**  
New England Life  
NEL Growth Fund  
NEL Equity Fund  
NEL Income Fund  
Money Market Gains  
Phone 872-2321  
4615 Oak Cass City

**OPTOMETRIST**

**Dr. David Batzer**  
Optometrist  
4624 Hill St.  
Cass City  
Office Hours:  
Mon.-Fri., 9:00-4:30  
872-3404

**Dr. G. W. McNiven**  
**Dr. R. R. Watson**  
Optometrists  
Primary Vision Center P.C.  
6506 E. Main, Cass City  
872-4374 or 872-4375  
Hours: Monday thru Friday 9-5  
Special Appointments Available

This space could be yours for as little as \$1.75 per week.

**PHYSICIANS**

**BALU K., M.D.**  
Obstetrician & Gynecologist  
70 North Elk Street  
Sandusky, MI 48471  
Phone (313) 648-4733  
Office Hours:  
Mon., Tues., Thurs., Fri. 9 to 5 - Appointment Only  
After Hours Call (313) 648-3770

**Harold T. Donahue**  
**M.D., A.A.F.P.**  
4674 Hill Street  
Cass City  
872-2323  
Office hours weekdays except Thursday

**Dr. J. Geissinger**  
Chiropractor  
Mon., Tues., Thurs., Fri. 9-12 a.m. and 2-6 p.m.  
Sat., 9-12 a.m.  
21 N. Almer, Caro, Mich.  
Across from IGA store  
Phone Caro 873-4464

**Richard A. Hall, D.O.**  
Osteopathic Physician  
4674 Hill St.  
Cass City, Michigan  
872-4446  
Office 872-4726 Home 872-4762

**Hoon K. Jeung, M.D.**  
Surgeon  
Specialist in Stomach and Bowel Problems  
9 a.m. to 5 p.m. Daily  
Saturday - 9 to 12 noon  
Closed Thursday  
6230 Hospital Drive  
Cass City, MI 48726  
Phone 872-4611  
Home 872-3138

**Dr. E. Paul Lockwood**  
Chiropractic Physician  
Office Hours: Mon., Tues., Wed., Fri. 9-12 noon and 2-5 p.m.  
Closed: Thursday and Saturday  
Phone 872-2765 Cass City for Appointment

**Beatriz G. Martin, M.D.**  
Internal Medicine  
4672 Hill St.  
Cass City, MI  
Phone 872-4331  
OFFICE HOURS:  
Mon.-Fri. 8 a.m.-5 p.m.  
Saturday 8 a.m.-Noon  
Accepting New Patients

**N. Y. Yun, M.D.**  
Physician & Surgeon  
Office Hours:  
Mon.-Fri. - 9 a.m. to 5 p.m.  
Thurs. - 9 a.m. to 12 p.m.  
Sat. - 9 a.m. - 12 p.m.  
6232 Hospital Drive  
Cass City  
Office 872-4733  
Res. 872-4257

**VETERINARIANS**

**COMPANION ANIMAL HOSPITAL**  
4438 S. Seeger St.  
Cass City - Phone 872-2255  
Rod Ellis, D.V.M.  
Carol Galka-Ellis, D.V.M.

**Edward Scollon, D.V.M.**  
Veterinarian  
Farm and Pet Animals  
Phone 872-2935  
4849 N. Seeger St., Cass City

Joyce Turner and children of Cass City made a Halloween visit at the home of Eugene and Marian Comment.

Mary Lenhard of Saginaw spent a day last week with her parents, Shirley and Bill Lenhard, and was an overnight guest.

While J.C. Pitcher of Sebawaing made a trip to Northern Michigan last Saturday, Madelyn Pitcher had as an overnight guest, her twin sister, Marian Carroll.

Thursday visitors at the home of Raymond Rabideau were his daughter and son-in-law, Jean and C.J. Marecki of Rochester. They also visited Gerry Carolan.

Mrs. W.C. Hunter underwent outpatient eye surgery at Bay Medical Center Friday and spent the weekend with her daughter, Deb Hunter, Caro, to recuperate.

Velma Helwig, Gerry Carolan, Marian Comment, Frances Newberry, Sally Patnaude and Gen Kehoe

## Jantz in medical school

Theophil A. Jantz of Owendale is among 125 new medical students entering the Michigan State University College of Osteopathic Medicine this fall.

Jantz, son of Theophil and Geraldine Jantz of Owendale, received the B.S. degree in biology from MSU in 1988 and was a 1984 graduate of Cass City High School.

The osteopathic medical students will take 8 terms of basic science, behavioral science and clinical studies on campus. They will then begin 60 weeks of clinical clerkships, including ambulatory and in-patient care, in community hospitals, clinics and health care agencies.

Upon completion of medical school, the students will receive the Doctor of Osteopathy (D.O.) degree, and after examinations may be licensed in any state to provide the full spectrum of health care.

Wedding Announcements and Invitations



Free Subscription with Each Order  
Catalogs loaned overnight.

The Chronicle

**DOOR PRIZES Refreshments**

**FREE GIFT for all our valued customers to express our appreciation for your patronage**

**Order your Grave Pieces now**

**JOIN US AT CASS CITY FLORAL**

**Christmas OPEN HOUSE**

Friday, Nov. 11 9-8 p.m.  
Saturday, Nov. 12 9-4 p.m.

Enjoy the pleasure of Christmas shopping in a tranquil setting of Christmas by Candlelight.  
The entire store will be lit by CANDLES.  
Friday 5:30 - 8 p.m.



Spin for a Discount for ADDITIONAL savings during our 2 days of OPEN HOUSE

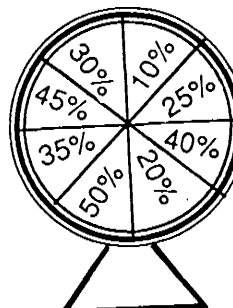

**Cass City Floral**  
6450 Main St. Cass City 872-3675  
2nd Location **Haist Flowers & Gifts** - Pigeon 453-2414  
Owners Joel and Carol Ingles

# Review hunter safety measures

Area hunters planning to take a crack at Michigan's bulging deer herd next week are urged to practice extreme caution and common sense in handling firearms. Last year 30 hunters were injured and 6 more lost their lives during the Nov. 15-30 firearm deer hunting season.

Twelve of the accidents (2 fatalities, 10 injuries) were self-inflicted, while the remaining 24 (4 fatalities, 20 injuries) were a result of another hunter's bullet. The 1987 figures were up from the 1986 firearm season, which claimed the lives of 4 hunters and injured 28

others, but were down slightly from 1985 statistics with a reported 31 injuries and 6 fatalities.

### Safety tips

1. **Treat every gun as if it were loaded** — you can never guarantee that your chamber is unloaded, so give an unloaded firearm the same respect you'd give a loaded firearm.
2. **Watch where you point your gun** — never point the muzzle at yourself or anyone else, even if it isn't loaded.
3. **Know your firearm** — make sure your firearm is in safe operating condition and the barrel free of obstructions. Double check the specifications of your ammunition to make sure it fits your gun.
4. **Don't load your gun before you're ready** — When traveling to and from your hunting blind, take down or have your actions open.
5. **Be sure of your target, and beyond** — Before you

squeeze the trigger, make sure you've carefully identified your target then look past it to be sure it's safe to shoot.

6. **Beware of fatigue** — when you've been out in the woods a long time fatigue can cause carelessness, which can cause accidents.

7. **Don't take chances with a loaded firearm** — never step over fences, jump ditches, or make other awkward or unbalanced moves while holding a loaded gun.

8. **Use care when practicing** — make sure your backstop will prevent ricochets and protect bystanders.

9. **Store guns safely** — store firearms unloaded, away from ammunition and out of the reach of children and inexperienced users.

10. **Remember, alcohol, drugs and firearms don't mix.**

## Firearm deer opener set

*Continued from page one.*

age in the upper Thumb. Another indication that the local deer herd is too large is the number of car-deer accidents that occur each year.

In 1987, there were 644 such accidents in Tuscola County. The accidents caused 16 injuries but no deaths. There were 558 deer-car accidents in 1986 and 472 in 1985.

In Sanilac County, there were 720 deer-car accidents in 1987, causing 28 injuries

and one death. The county had 605 such accidents in 1986 and 525 in 1985.

Huron County recorded 522 accidents last year, causing 18 injuries and no deaths. In 1986 there were 510 deer-car accidents, compared to 438 in 1985.

Hunters who plan to bag a deer in the upper Thumb are expected to find the best hunting in eastern Tuscola, eastern Huron and northern Sanilac counties.



CASS CITY'S PHIL Retherford, his son, Ed, and Bernie Hurt posed for the camera after a successful pheasant hunting trip in the early 1960s.

## Fall Tractor Specials

**Nothing Runs Like a Deere** Especially from Laethem's USED TRACTOR SALE

- Farmall Cub, electric start, 54" front blade, hydraulic lift
- Farmall A with turf tires, flail mower 48" IHC 460 gas, Hi-utility. Power steering, 3 pt. 1958
- John Deere LA, starter lights, new paint
- John Deere A, 1949, Narrow Front, power trol, 801 hitch
- John Deere 60, Wide Front, 801 hitch
- John Deere 320 gas, 2 cylinder with 12.4x24 rear tires with hydraulic controlled sickle bar mower. Live hyd.
- John Deere 2240 MFWD with 240 self-leveling loader, 72" bucket.
- John Deere 2040, diesel, new motor, 145 loader, Independent valve, 3 pt.
- Belt pulley assem. John Deere to fit most J.D. utility tractors 1020 to 2750
- John Deere 4240, quad range, SGB, 16.9x38 rears Case 2290, 1982, 12 speed power shift, cab, heat & air, 20.8x38 duals, 130 H.P.
- John Deere 4020 diesel, 1967, 15.5x38, dual hyd., 3 pt
- John Deere 4020, 1971, side console, dual hyd. good 15.5x38, wide front with ILLx15, diff. lock
- Steiger Puma 1000, 12 speed power shift, steerable front axle 16.9x38 dual radials, 4 outlets, 3 pt. PTO, stereo, air, seat. Demo 90 hours.

**LAETHEM'S**

673-3939

245 Columbla St., Caro, Michigan

"AROUND HERE IT'S JOHN DEERE"



CASS CITY VILLAGE and Hardee's officials, and a large, furry California raisin gathered for Hardee's ribbon cutting ceremony Thursday at the new Cass City restaurant, which opened Oct. 31.

**For The HOLIDAYS & EVERYDAY**



**A Whirlpool Gas Dryer**

Mom would love a new Whirlpool Gas Dryer from Southeastern Michigan Gas Company for the holidays and everyday. Loaded with many fine features to make the laundry chore easier, Whirlpool has just the model to meet her needs.

USE OUR CONVENIENT PAYMENT PLAN  
OPEN MONDAY - FRIDAY 8-5

**Southeastern Michigan Gas Company**

Sandusky: 648-2334

Check your telephone directory for a toll free number in your area.

# SUPER SUNDAY

AT CASS CITY'S

**Ben Franklin & the PAINT STORE**

WHERE EVERYTHING YOU BUY IS GUARANTEED — CASS CITY

6544 MAIN ST. - CASS CITY 872-2445

# SUNDAY, NOV. 13

# 12 noon till 5:00 p.m.

Sorry No Layaways



## Marlette visits Friday

# Hawks split league games as Broncos claim title

Cass City High School Red Hawk basketball fans will get a preview of what is expected to be a key match up in the Class C district tournament at Cass City this year when Marlette comes to town Friday.

Marlette holds a victory over the Hawks in the first game between the 2 schools, and it will be interesting to see if the home court advantage will be great enough for the Hawks to even the score. The tournament will be held at Cass City this year.

It's lucky for both Marlette and Cass City that North Branch is not in Class C, because it would be an upset of monumental proportions if either school could defeat the unbeaten league leaders.

After the Broncos topped the Hawks 44-30 Thursday, Coach Marty Daniel called North Branch the best team that he had seen in 12 years of coaching.

Despite the difference in the final score, fans were treated to fine basketball by 2 well coached teams.

The Hawks stayed in the battle for the first quarter

Friday's game with Marlette is of extra interest for 2 reasons. The winner will probably finish second in the Thumb B Association. The game could well be a match up between the 2 teams that will battle for the District Class C title in the tournament scheduled in Cass City.

and a half, but it was apparent that it was only a matter of time before the Broncos took control. The difference was the power on the boards that North Branch possesses. The Hawks' primary board work was handled by Darlene Monroe while the Broncos assaulted the board with 4 tall girls, Katrina Costello, Chris Lovasz, Stacey Lamphere and Kristine Deshetsy. A key to the Bronco power was that Lamphere, a top rebounder and Miss Everything for North Branch, was playing point guard part of the time against the Hawks.

An indication of the Bronco rebounding strength was apparent in the early

going when the first 8 points scored by the visitors came on rebounds or foul shots earned when trying to shoot rebounds.

The Hawks gave ground grudgingly all game, spearheaded by tight defense. The Broncos got no cheap baskets all night, other than a break away that came on a turnover caused by pressure defense, but often were able to keep on shooting until the baskets were made.

The game was decided in the middle 2 quarters when Cass City scored a total of 8 points. The Hawks were outscored by Lamphere in the 2 periods as she netted 9 points. Lamphere ended the game with 17 points while

Monroe was in double figures for Cass city with 10.

### BAD AXE GAME

It appears that the Hawks will end up second or third in the Thumb B Association this season following a victory over Bad Axe last Tuesday, 42-34. It took a quarter for Hawk girls to get their heads in the game as the Hatchets scored 16 points in the first 8 minutes, more than the team allowed powerful North Branch in any period Thursday.

Trailing by a basket at the end of the quarter, the Hawks went to work and shut down the Hatchets, including Missey Cubitt, who scored 8 points in the first period, the rest of the way.

It was fortunate for Cass City that the defense stiffened, because the offense wasn't all that potent all night. Monroe and point guard Jandi Hillaker accounted for all of Cass City's points in the second quarter

(8), but the meager output was enough to give the Hawks a 22-21 lead at the intermission as the defense limited the Hatchets to a basket and 3 free throws.

With a balanced attack, the Hawks went in front 34-29 at the end of 3 quarters and were on top in the low scoring final period, 8-5, to register the Thumb B Association victory. Cubitt, with 14 points, led all scorers while her teammate, Jenny Gavitt, netted 11. Monroe, with 12, and Hillaker, with 10, were in double figures for Cass City.

### JV GAMES

It was a great week for the Hawk junior varsity. The Hawk JV bested North Branch in a nip and tuck game, 57-53, and then ran roughshod over the Bad Axe JV, 47-25.

"Great ideas come from the heart." Vauvenargues

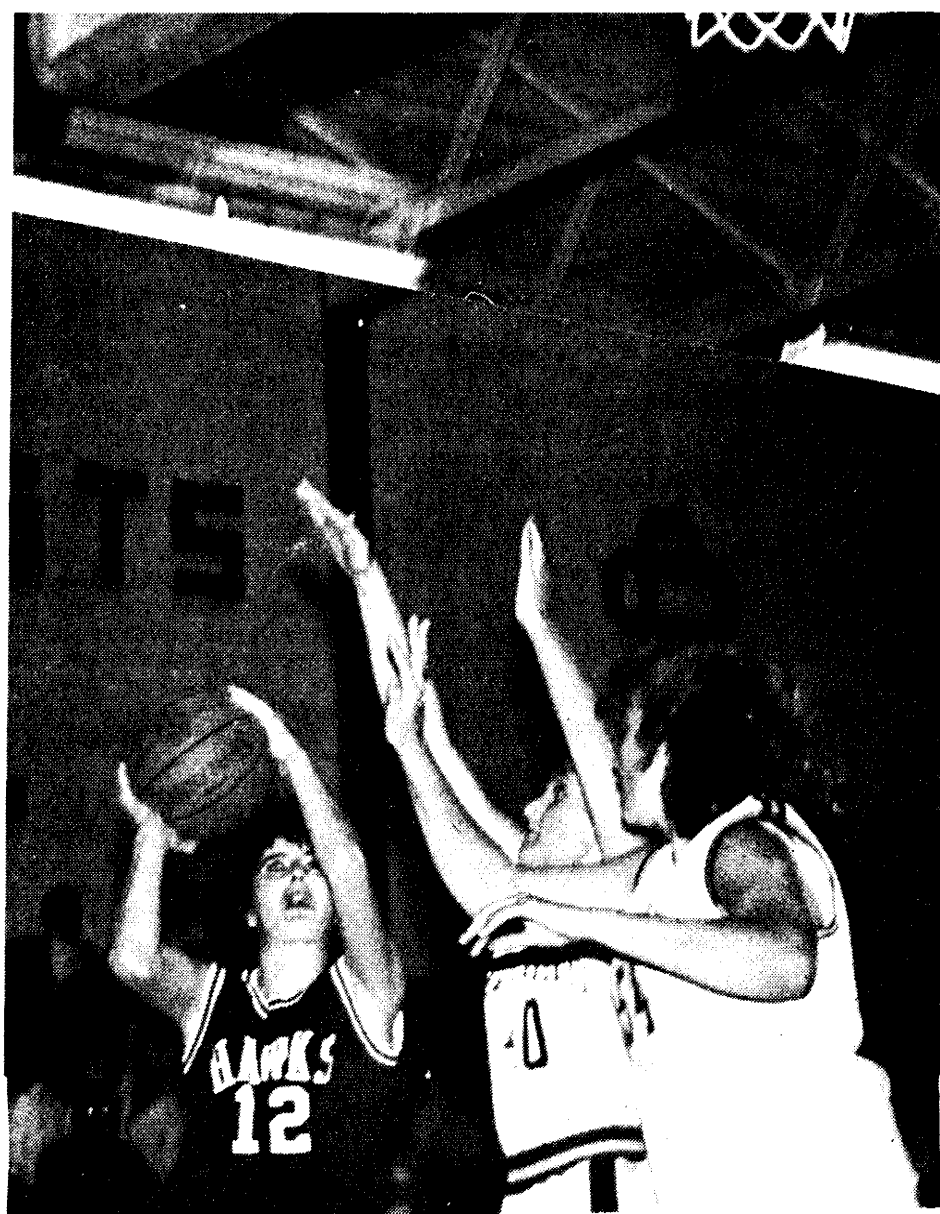

Sue Papp goes up in traffic for 2 points as the Cass City Red Hawks easily defeated the Bad Axe Hatchets, 42-34, in a Thumb B Association game.

## After win over C-PS

# O-G near league title share

Barring a gigantic upset in the final 2 games, the Owen-Gage Bulldogs will end the regular basketball season no worse than tied for the championship in the North Central Thumb D Conference.

The Bulldogs have games left with Caseville, Tuesday, Nov. 8, and Kingston, Tuesday, Nov. 15, 2 teams that they defeated the first time they met.

Owen-Gage looked like league champions Friday as the team overpowered Carsonville-Port Sanilac, 64-

34. It was a mismatch all the way as the Bulldogs raced off to a 16-4 first quarter lead and never looked back.

C-PS stiffened a little in the second period and actually outscored the Bulldogs, 13-12, to keep the score respectable at the half, 28-17. But Coach Dean Roller

had his charges go to a pressing defense and C-PS couldn't handle it, often having trouble getting the ball in play in the front court because of the Bulldog half-court trapping defense. With the game well in hand, Roller was able to give his entire team playing time.

Fourteen players saw action and 13 broke into the scoring column.

Although she sat out most of the fourth quarter, Andrea Goslin led all scorers with 17 points. Andrea Mandich was also in double figures with 10 points. Debbie Olds led Caseville with 12 points.

### BASKETBALL STANDINGS

THUMB B ASSOCIATION				NCTL			
	League	Overall		League	Overall		
	W	L	W	L	W	L	
North Branch	11	0	16	0	Owen-Gage	12	2
Cass City	8	3	12	4	Deckerville	12	2
Marlette	8	3	14	3	Peck	11	2
Lakers	6	5	11	6	Akron-Fair	8	4
Imlay City	4	7	7	9	North Huron	8	5
Vassar	3	7	5	11	CPS	3	10
Caro	2	8	2	15	Caseville	3	10
Bad Axe	1	10	1	17	Port Hope	2	11
					Kingston	0	13

Owen-Gage	FG	FT	PTS
Ricker	4	-	8
M. Goslin	1	-	2
A. Goslin	7	3-5	17
Norcross	1	0-1	2
Winchester	1	-	2
Dorsch	4	-	8
Schwartz	1	1-2	3
Mandich	4	2-3	10
Bolzman	4	-	8
Salcido	0	1-2	1
Grassmann	1	-	2
Enderle	-	1-2	1

CPS	FG	FT	PTS
Hastings	2	3	5
Olds	5	2-2	12
Milarch	1	2-3	4
Mattox	1	-	3
Baranowski		2-8	2
Messing	1	1-3	3
Sullivan	2	1-2	5

## Top bowlers post top scores in tourney

The second annual Thumb National Bank scratch bowling tournament held last weekend was won by fifth seeded Gary Goodwine, who defeated Dick Doerr 289 to 221 in the finals at Charmont Lanes.

There were 24 bowlers in the competition and to win, Goodwine defeated 5 opponents. In the first round, a 2-game series, he topped Ken Gremel, 427 to 387.

Goodwine's most narrow victory was in the second round, when he bowled his lowest round of the tournament to register a 211 to 202 victory over Rodney Hood. It was Goodwine's lowest average game in the competition.

In the third round, Goodwine defeated the defending champion Jim Hoffman, 267-170. In the last 3 games, the champion bowled 267, 230, 289 for a total of 786. High scores were commonplace, but 2 were outstanding even in this exalted competition. Ken Gremel posted a 297 and Fred Foster a 298.

The Want Ads Are Newsy Tool

**FALL CLASS RING SALE**

**\$74.95**

Full name feature, diamonds and CZ's are extra charge.

Special price good until November 30, 1988

**McConkey Jewelry & Gift Shop**

Phone 872-3025

OFFERED EXCLUSIVELY BY R. JOHNS, LTD.

**PAY FOR CHRISTMAS IN ADVANCE.**

Year after year, many customers tell us that the only way they can pay those Christmas bills is to do it in advance with Christmas Club systematic savings. Now is the time to start paying your 1989 Christmas bills. So visit a nearby Chemical Bank and open your Christmas Club soon.

**CHEMICAL BANK**

Bay Area

*We're here to help you.*

MEMBER F D I C / EQUAL HOUSING EQUAL OPPORTUNITY LENDER

Substantial interest penalty for early withdrawal.

**CASS CITY PEOPLES CHOICE MARKET**

PHONE 872-4346

ANNOUNCES WE ARE NOW OPEN AND

**READY TO SERVE YOU**

**OPEN 24 HOURS FOR YOUR CONVENIENCE**

Dairy Products

Fresh Coffee

**BEER & WINE**

**FAST FOODS TO GO!**

Sandwiches

Hot Dogs - Chili Dogs

Nachos

Pizza

Popcorn

Hand Dipped Ice Cream

Hot Pretzels

**WE ALSO SELL**

- GASOLINE
- KEROSENE
- DIESEL FUEL

**SEBEWAING**

883-3911

**PIGEON**

453-2758

6144 E. Cass City Rd.

**OPEN 24 HRS.**

# World Premiere of piece written for Bach Festival set Nov. 27

The world Premiere of "Symphonic Dialogues II" written for the Village Bach Festival will be heard during the final concert of the tenth anniversary of the Festival, Sunday, Nov. 27, at 3:15 p.m.

Ray E. Luke, composer, will discuss his composition, "Symphonic Dialogues II", at an open lecture at 2:00 p.m. the 27th at the First Presbyterian

Church, Cass City, home of the Village Bach Festival. Luke is professor of theory and composition, and conductor of University and Opera Productions at Oklahoma City University. He holds a PHD in music theory and composition from Eastman School of Music. Luke combines his teaching responsibilities with guest conducting throughout the Midwest and abroad. He composes chamber, opera, choral and concert band music.

"Symphonic Dialogues II" is dedicated to Catherine Paulu, oboist and soloist of the Village Bach Festival, who died last winter. "Symphonic Dialogues I" was written earlier for oboist Catherine and violinist Norman Paulu and the Oklahoma City Orchestra. The new composition will reflect the oboist's musical life and Bach's dedication to music as life. The text is from The Rubaiyat of Omar Kayyam.

The premiere of "Symphonic Dialogues II" will be conducted by A. Clyde Roller of San Antonio, Texas. Soloists will be Norman Paulu, violin; Penelope Jensen, soprano; Don Th. Jaeger, oboe, and Catherine McMichael, harpsichord. The strings of the Village Bach Festival will accompany them.

"This is a unique opportunity for our community and the Festival," says Holly Althaver, founder and chairwoman. "We honor a dedicated musician and we celebrate 10 years of the Village Bach Festival. We are adding to the cultural riches of 20th century American chamber music and we will be acknowledged whenever this piece is played as the organization for whom the music was written."

The Village Bach Festival begins Tuesday, Nov. 22, with a recital in the First Presbyterian Church of Caro, and follows with concerts Friday, Nov. 25, and Saturday, Nov. 26, at 8:15 p.m. in the First Presbyterian Church, Cass City.

The Village Bach Festival is made possible with the support of the Michigan Council for the Arts.

Ticket information may be obtained by calling 872-5400 between 1:00 p.m.-5:00 p.m. Monday through Friday. Other information is available by calling 872-3465 or 872-2131, extension 269.

# North Central Thumb League football All-Stars announced

League champion Deckerville and Kingston dominated the North Central Thumb League all-star football team selected by the league coaches. Oddly enough, Owen-Gage, which finished in a tie for second with Kingston, failed to have a player elected to either the offensive or defensive teams.

In addition to the first teams selections, Deckerville had 9 players on the second teams and Kingston, 4.

Owen-Gage was limited to 2 players winning 3 positions on the second teams. Marc Reinhardt was named as a running back on offense and linebacker on defense. Nick Pavlichek was named at end.

The complete squads:

- |                                                                                                 |                                                                                                                                                                                                                                                       |                                                                                                                                                                                                                              |
|-------------------------------------------------------------------------------------------------|-------------------------------------------------------------------------------------------------------------------------------------------------------------------------------------------------------------------------------------------------------|------------------------------------------------------------------------------------------------------------------------------------------------------------------------------------------------------------------------------|
| <b>RUNNING BACKS</b>                                                                            | <b>HALFBACK</b>                                                                                                                                                                                                                                       | <b>KICKER</b>                                                                                                                                                                                                                |
| *Ron Moore, Kingston (SR); *Richard Barker, Deckerville (SR); Jeff Green, Akron-Fairgrove (SR). | *Richard Barker, Deckerville (SR); Jim Fourman, Kingston (SR).                                                                                                                                                                                        | Haroldo Leite, Kingston (SR).                                                                                                                                                                                                |
| <b>QUARTERBACK</b>                                                                              | <b>KICKER</b>                                                                                                                                                                                                                                         | <b>HONORABLE MENTION</b>                                                                                                                                                                                                     |
| Shane Campbell, Kingston (SR).                                                                  | *Jeff Green, Akron-Fairgrove (SR).                                                                                                                                                                                                                    | Todd Brink, Akron-Fairgrove; John Allard, Tim Garavaglia, Dan Brown, Deckerville; Dave Retan, Kingston; Scott Romzek, North Huron; Chad Stirett, Nick Pavlichek, Bill Ehrlich, Owen-Gage; Jeremy Abrego, Bob McKernan, Peck. |
| *Unanimous choice.                                                                              | *Unanimous choice.                                                                                                                                                                                                                                    |                                                                                                                                                                                                                              |
| <b>OFFENSE - 2ND TEAM</b>                                                                       | <b>LINEMEN</b>                                                                                                                                                                                                                                        |                                                                                                                                                                                                                              |
| <b>CENTER</b>                                                                                   | Marshall Deline, Kingston (SR); Shannon Hill, Kingston (SR); Duane Miller, North Huron (SR); Tim Moore, Akron-Fairgrove (JR); Mike Errer, Owen-Gage.                                                                                                  |                                                                                                                                                                                                                              |
| Tim Stolicker, Deckerville (JR).                                                                | <b>LINEBACKER</b>                                                                                                                                                                                                                                     |                                                                                                                                                                                                                              |
| <b>GUARDS</b>                                                                                   | Ron Moore, Kingston (SR); Jason Tait, Kingston (JR); Marc Reinhardt, Owen-Gage (SR); Stephen Kecke, Deckerville (SR); Daryl Bolsby, Deckerville (SR).                                                                                                 |                                                                                                                                                                                                                              |
| Charles Maynard, Kingston (JR); Jassen Dowling, Peck (SR); Stephen Kelke, Deckerville (SR).     | <b>HALFBACK</b>                                                                                                                                                                                                                                       |                                                                                                                                                                                                                              |
| <b>TACKLE</b>                                                                                   | Dan Armstead, Deckerville (SR); Pete Volk, Akron-Fairgrove (SO).                                                                                                                                                                                      |                                                                                                                                                                                                                              |
| Tim Moore, Akron-Fairgrove (JR); Dan Brown, Deckerville (JR).                                   | <b>RUNNING BACKS</b>                                                                                                                                                                                                                                  |                                                                                                                                                                                                                              |
| <b>ENDS</b>                                                                                     | Marc Reinhardt, Owen-Gage (SR); Carl Krosnicki, Peck (SR); Dennis Kussrow, Peck (SR); Dan Armstead, Deckerville (SR).                                                                                                                                 |                                                                                                                                                                                                                              |
| <b>GUARDS</b>                                                                                   | <b>QUARTERBACK</b>                                                                                                                                                                                                                                    |                                                                                                                                                                                                                              |
| Adam Eurich, Akron-Fairgrove (JR); Rob Zeien, Deckerville (SR).                                 | Jamie Kolowich, Carsonville-Pt. Sanilac (SR); Pete Volk, Akron-Fairgrove (SO); Terry O'Connor, Deckerville (SR).                                                                                                                                      |                                                                                                                                                                                                                              |
| <b>TACKLE</b>                                                                                   | <b>HONORABLE MENTION</b>                                                                                                                                                                                                                              |                                                                                                                                                                                                                              |
| Richard Lance, Kingston (JR); Gary Utter, Peck (SR).                                            | Wade Miller, Brian Greania, Akron-Fairgrove; Joe Rickett, Carsonville-Pt. Sanilac; Tim Garavaglia, Deckerville; Dan Syms, Lonnie Stark, Kingston; Paul Bambach, Brad Kirkpatrick, North Huron; Kevin Koch, Brian Abbe, Owen-Gage; Ross Bradley, Peck. |                                                                                                                                                                                                                              |
| <b>ENDS</b>                                                                                     | <b>DEFENSE - 1ST TEAM</b>                                                                                                                                                                                                                             |                                                                                                                                                                                                                              |
| Scott Kochanski, Carsonville-Pt. Sanilac (SR); Jim Fourman, Kingston (SR).                      | <b>LINEMEN</b>                                                                                                                                                                                                                                        |                                                                                                                                                                                                                              |
|                                                                                                 | *Tim Enos, Akron-Fairgrove (SR); *Gary Utter, Peck (SR); Dale Stolicker, Deckerville (SR); Steve Heilig, Deckerville (SR); Dave Castillo, Deckerville (JR); Keith Simpson, Kingston (JR); Richard Lance, Kingston (JR).                               |                                                                                                                                                                                                                              |
|                                                                                                 | <b>LINEBACKER</b>                                                                                                                                                                                                                                     |                                                                                                                                                                                                                              |
|                                                                                                 | *Rob Zeien, Deckerville (SR); Jeff Green, Akron-Fairgrove (SR); Joe Rickett, C.P.S. (SR); Dennis Kussrow, Peck (SR).                                                                                                                                  |                                                                                                                                                                                                                              |

**Low rates make State Farm homeowners insurance a good buy. CALL ME**

Ernest A. Teichman, Jr.  
6240 W. Main  
Cass City, Mich.  
Phone 872-3388



**Be Sure To Take It All!**

Your doctor prescribes a specific number of pills when he writes a prescription. By using the entire quantity at the required frequency, you make sure that the medication provides its full benefits, just as your doctor prescribed.

**Remember - The Price is Discounted... NEVER the Quality at COACH LIGHT PHARMACY**

CASS CITY 872-3613

**Weekly Trust Department Hours at Cass City WEDNESDAYS 10 a.m. till 4 p.m.**

Call for an Appointment or just stop in and talk with John Schaefer, our experienced, Trust Officer



**Thumb National Bank**

**9.00%\***

- IRA's and Keogh Plans
- Tax Deductible Contributions
- Accumulation Free of Current Income Tax
- Many Retirement Options

For Details:  
**HARRIS & COMPANY**  
Newell Harris 872-2688

6815 E. Cass City Road Cass City  
\*Current Rate

## Senior services contract settled

A tentative senior services agreement reached late last month by the Human Development Commission and Region VII Area Agency on Aging executive boards received final approval Thursday from the full Region VII board.

The agreement, which settles a dispute between the 2 parties over reimbursement rates for certain senior services, had already been approved by the full HDC board, which empowered its executive board to act on the contract.

Mary Ann Vandemark, HDC executive director, said Friday she's relieved. "I think it's workable," she said of the contract. "I'm confident we can keep the quality up, and that was our main concern."

The dispute, aired during contract negotiations in late September, focused on proposed reductions of reimbursement Region VII provides to HDC for home delivered and congregate meals, and case coordination and support services.

HDC officials indicated cuts in their proposed budget would mean a reduction in the quality of services. Region VII Director Mohammed Kahn, however, said administrative costs were too high and that by cutting those expenses more seniors could be served in the programs.

Vandemark said the approved contract represents compromise on both sides. "What we did was cut \$27,000 to \$30,000 out of the budget," she explained, adding the reimbursement rates agreed upon are \$1.65 for congregate meals, \$1.70 for home delivered meals, and \$9.14 for case coordination and support services.

Despite the lower-than-requested rates, HDC will still provide the same number of meals (91,150 congregate and 146,120 delivered) it had planned initially, Vandemark said.

**Wedding Announcements and Invitations**  
Catalogs loaned overnight.  
FREE SUBSCRIPTION WITH EACH ORDER.  
**The Chronicle**

**FUEL OIL, L.P. GAS, GAS SALES and SERVICE HEADQUARTERS**

**THUMB BURNER SERVICE**  
Corner West and Main St.  
Phone 872-2065  
2 Servicemen  
✓ Experienced  
✓ Qualified  
to handle your Oil or Gas Furnaces  
Air Conditioning  
Complete Installation Service

**CASS CITY OIL & GAS - PROPANE 872-2065**

**L.P. GAS for HOME HEATING FARM CROP DRYING INDUSTRIAL USE**

**We Sell GAS FURNACES GAS HOT WATER HEATERS GAS SPACE HEATERS**

COME TO MR. CHIPS FOR FAST, FRIENDLY SERVICE Mufflers and Tune-ups

**15 MINUTE OIL CHANGE**

SAVE ON TIRES  
Phone 872-3850

WAITING AREA FOR CARS  
**MR. CHIPS SERVICE CENTER**  
formerly VillageService Center  
CASS CITY

**SUPER FLOW PREMIUM FUEL OIL**

**FEATURING:**  
This custom balanced formulation contains special moisture dispersing agents which constantly work toward prevention of moisture accumulation from condensation.

- Four Point Reduction - 20-30 F.
- Moisture Dispersant • Ashless
- Lowest Conradson Carbon Residue

By using Super Flow Fuel Oil in your home, you will notice during the sub-zero temperatures your fuel oil will burn more efficiently. Super Flow Fuel Oil is a refined #2 fuel oil to help reduce normal winter problems associated with cold temperatures.

**SAME PRICE AS REGULAR HEATING OIL**  
**Cass City Oil & Gas Co.**  
6407 Main St., Cass City, MI 48726  
Phone 872-2065 or 872-3122  
WHOLESALE & RETAIL GAS, DIESEL, FUEL OIL, MOTOR OIL

**The Paint Store**

**SUPER PAINT SPECIALS**

It's Famous For A Reason: QUALITY!

**\$9.99 Gal.** Reg. \$15.99  
**SAVE \$6.00**

**\$9.99 Gal.** Reg. \$13.99  
**SAVE \$4.00**

**Beautiful, scrubbable flat finish**  
• Easy water clean-up  
• Variety of popular colors

**Low Luster Finish with Contemporary Style!**  
• Durable, washable low luster finish  
• For walls, woodwork, trim work  
• Latex-urethane application and clean-up

6544 MAIN ST. - CASS CITY 872-2445

**the PAINT STORE**



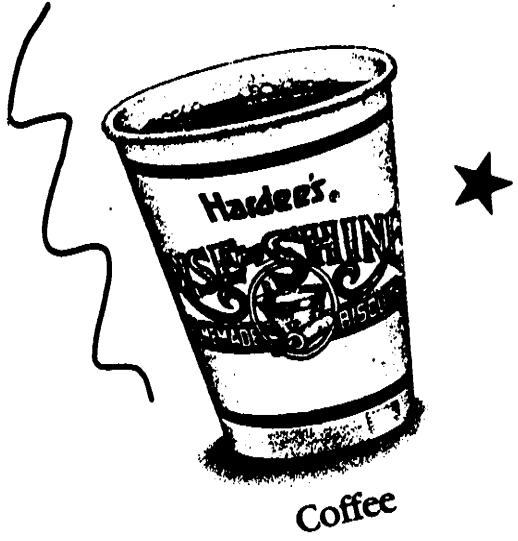

Coffee

Big Deluxe™  
Burger

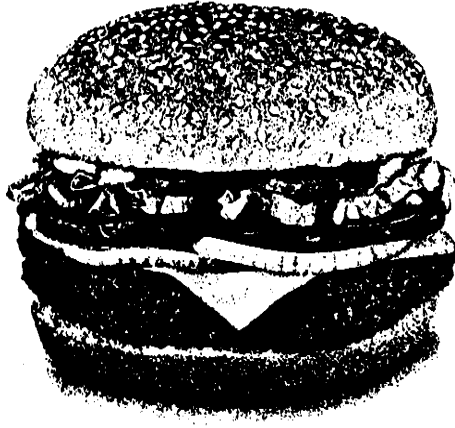

Cool Twist™  
Cones and Sundaes

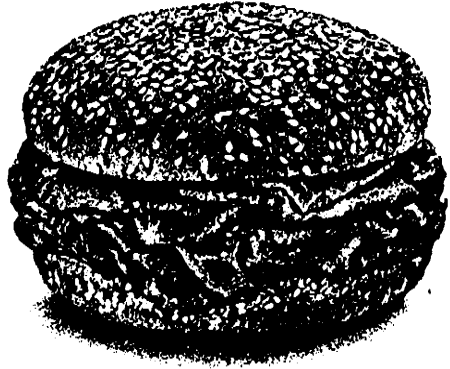

Roast Beef Sandwich

# NOW SERVING

# THE CASS CITY

# Hardee's®

# GRAND

# OPENING

# SWEEPSTAKES!



Hash Rounds™ Potatoes



Cinnamon 'N' Raisin™ Biscuit

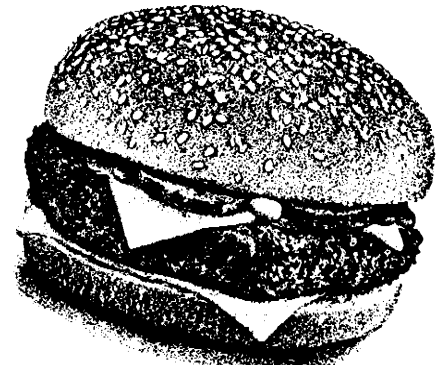

1/4 lb. \* Cheeseburger

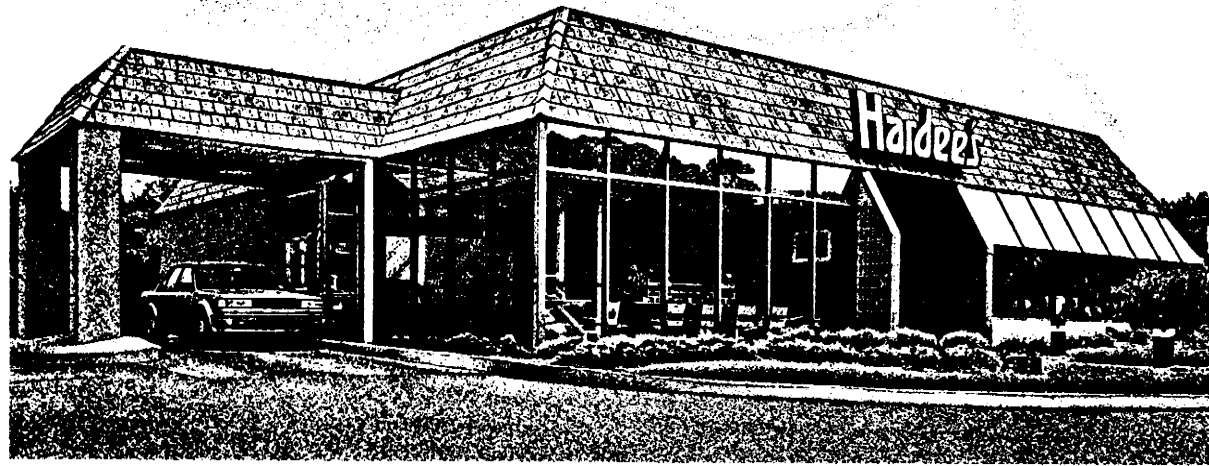

French Fries

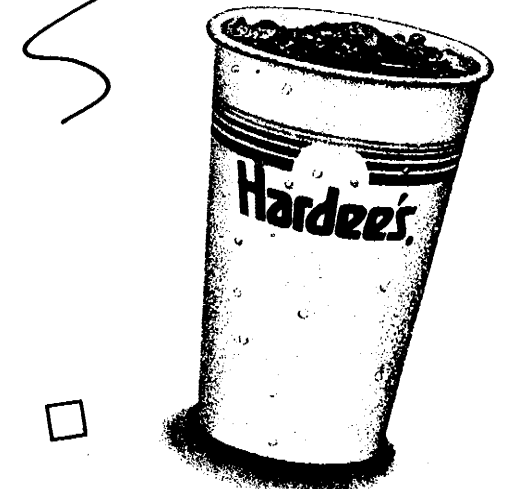

Soft Drinks

## Can you guess how many Big Deluxe™ Burgers we'll serve?

C'mon, give it a try! Just fill out an entry form and tell us how many Big Deluxe™ Burgers you think we'll serve during our Grand Opening Celebration – that's November 4th through November 26th. If you guess right, you could leave the new Cass City Hardee's restaurant a very big winner. The fact is, we're so excited about our new Hardee's, we're giving away some terrific prizes to help celebrate:

★ ★ ★ November 27, 1988 ★ ★ ★

- Awarding of the  
**Grand Prize: A 21" Color TV**
- Second Prize: A Compact Disc Player**
- Third Prize: A 10-Speed Bike**

Plus there will be hourly drawings Saturday, November 26 and Sunday, November 27, from 10 a.m. to 2 p.m. for other prizes – including our famous 2" Raisin Guys figurines.

What are you waiting for? Get in on the great food, lots of fun and terrific prizes.

**Stop by the Cass City Hardee's restaurant today for details and your entry form!**

6209 Main Street in Cass City (at Nestle)

No purchase necessary. See rules at restaurant for complete details. You need not have the correct guess to be eligible for the hourly drawings and you don't have to be present to win.



Rise 'N' Shine™  
Breakfast Biscuits

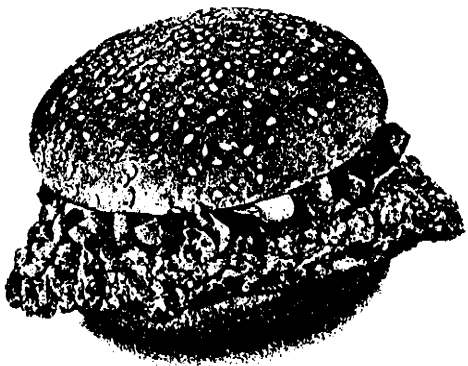

Chicken Fillet Sandwich

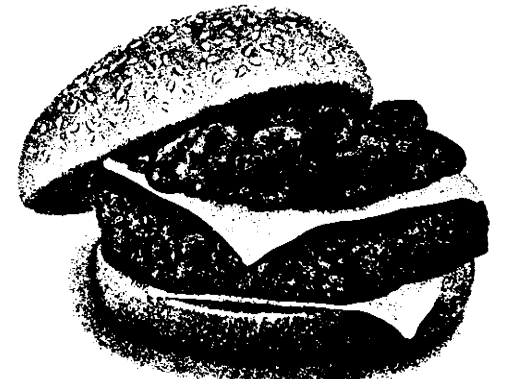

Mushroom 'N' Swiss™ Burger



Shakes



Garden Fresh Salads



Bacon Cheeseburger

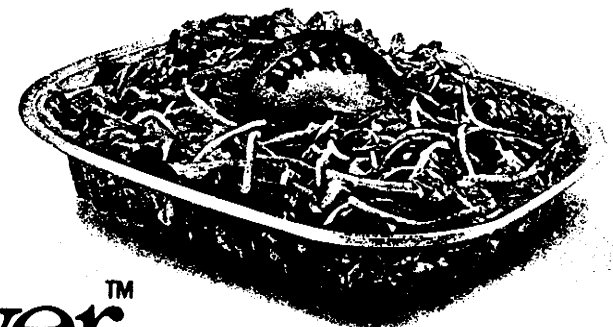

# Hardee's

## We're out to win you over.™

# Gyomory, Purvis help manage auto industry show

Two area residents attending school at Northwood Institute took part in managing the schools 25th annual Automotive Industry Show, held Oct. 21-23 at the Midland campus.

David R. Purvis, a junior from Cass City, was recreation chairman of the show, while Brian J. Gyomory, also a junior from Cass City, was business manager.

for the 1987 show. Purvis has worked in sales for 2 consecutive summers, and hopes to some day own a dealership.

Gyomory is the son of Jim and Judy Gyomory. He has earned an associate degree in accounting and is currently working toward a bachelor's degree in accounting. Also an active member of Chi Alpha Mu fraternity, he holds the office of treasurer.

Gyomory has been a team member for Oldsmobile for the past 2 years as well as working for Albro Corporation in the finance department. He plans to pursue a career in accounting.



David R. Purvis

Purvis, the son of Shirley Purvis, has earned an associate degree in automotive marketing, and is working toward a bachelor's degree in management. Currently the president of Chi Alpha Mu fraternity, he participated as Oldsmobile captain



Brian J. Gyomory

Northwood Institute's Automotive Industry Show annually attracts thousands of spectators.

The show is administered, promoted and conducted entirely by Northwood students representing many of the college's business management curriculums, including automotive marketing, service management, automotive aftermarket management, truck marketing and advertising.

Teams are organized for each car and truck line, both domestic and import, along with teams managing the automotive aftermarket segment of the show. The team captains and supporting crews compete and are judged on innovative planning, displays and product knowledge.

This year, as in the past, there were about 500 cars, trucks and recreational vehicles on display with about an equal number of students involved in various activities.

## USE LOW COST CHRONICLE CLASSIFIED ADS

**Transit (nonbusiness) rates.** 10 words or less, \$1.25 each insertion; additional words 7 cents each. Three weeks for the price of two - cash rate. Save money by enclosing cash with mail orders. Rates for display want ad on application.

### Automotive

1979 FORD Fairmont wagon, 302 cubic inch, low miles, \$700, must sell. 1976 Buick Skylark, V6, 231 cubic inch, AM/FM cassette, \$200, must sell. Call 872-4012 after 4 p.m. 1-11-9-1

### Automotive

1985 OLDS Calais, charcoal gray, air conditioning, power steering, power brakes, cruise, AM-FM, good condition in and out. Call 872-3529 evenings. 1-10-26-3

FOR SALE - 1974 Olds, runs good. Call evenings 872-2588. 1-10-26-3

FOR SALE - 1969 Ford motor home. No rust, clean, self-contained. In good condition. Call 872-2397. 1-10-26-3

FOR SALE - 1986 Chevrolet Celebrity, excellent condition, \$6000. Call 872-3839. 1-11-9-3

FOR SALE - 1986 Ford Mustang LX, 4 cylinder, 4 speed, power steering, power brakes, sunroof, cruise control, 25,000 miles. \$5995.00. Call nights 872-3628. 1-11-9-3

1986 OLDS 98 Regency Brougham, 4 door, in excellent condition, medium gray color, loaded. Call 872-2592. 1-11-2-3

FOR SALE - 1978 Ford Granada, runs good. 6466 6th St., phone 872-2396. 1-10-26-3

### General Merchandise

FOR SALE - used cornet with case and accessories. Ask for Steve, 6620 Houghton St., Cass City. 2-11-9-3

FOR SALE - Music instruments, used cornet \$75, flute, 1 1/2 years old \$200. Call 872-4275. 2-11-9-3

COATS AND jackets, hats, scarves, gloves and mittens - Now at Georgine's in Cass City. 12 1/2-32 1/2. 2-11-9-1

18-CU-FOOT Avocado Philco refrigerator, \$175 or best offer. Phone 872-2236. 2-10-26-3

FOR SALE - commode, like new. Call 872-2010. 1-11-2-2

LORANN FLAVOR oils, over 30 in stock. Coach Light Pharmacy. 2-11-2-7

FOR SALE - John Deere 38 inch snow thrower. Call 872-5336 after 5. 2-11-2-3

FOR SALE - 304 V8 International motor. Two 8.75x16.5 snow tires on rims \$50.00. Four 8.00x17.5 snow tires on rims \$50.00. Phone 872-3901. 2-10-26-3

### General Merchandise

FOR SALE - Cedar posts; picnic tables, lawn swings, wishing wells, clothes line poles, lawn chairs, wooden flowerpots. 4351 Rescue Road, Cass City. Call 872-2039. 2-13-19-1f

SCHWEITZER Orchards - now selling Ida Red, Jonathan, red and yellow Delicious, Northern Spy, Winesap, McIntosh apples. North on Cemetery Rd. to Sebawaing Rd., 3 miles east, 1/2 north, 3168 Grassmere. Call 269-7008. Open daily 9:30 to 4:30. 2-11-2-1

SCHWEITZER Orchards has apples for sale which are rejects and sort-outs, \$3.50 bushel in your own containers. 3168 Grassmere Rd. Call 269-7008. 2-11-9-1

4 used 35x12.50 R15 B.F.G. all-terrain T/A mounted on 4 turbo vec aluminum rims. Excellent condition. 6 on 5 1/2 G.M. bolt pattern. 2-11-2-1

4 used 31x10.50 R16.5 B.F.G. all-terrain T/A R.W.L. mounted on 4-bolt chrome mod rims. Will fit all 8-bolt pickups. 2-11-2-1

2 15x8 white wagon rims. 2 15x10 white wagon rims, excellent condition, with center caps and lugs. 5 hole G.M. bolt pattern. 2-11-2-1

1 new 16-ft. tandem trailer  
1 used 16-ft. steel tandem trailer  
1 full size roll bar  
4 1970 thru 1975 stock Mopar rally rims - 14-inch.  
2 18.4x26 Goodyear 10 ply combine tires, used, excellent condition. 2-11-9-3

### Cass City Tire

6392 Main St., Cass City 2-11-9-1

FOR SALE - Duraliner toolbox for full size pickup, like new, \$75. Can be seen at Wesley Milk Co., Cass City. 2-11-9-3

### The Thumb Yarn Shop

8 miles north of M-81 and M-53 intersection and 1/2 mile west on Rescue Road. Open daily 12:00 till 9:00 p.m. 2-3-12-1f

FOR SALE - 6 windows 27"x36", 2 windows 27"x36", All with storms and screens. Call 872-2635 after 5:00. 2-11-2-3n

### General Merchandise

FOR SALE - fresh turkeys for Thanksgiving, large or small, dressed or alive. Also available for Christmas. Kitchen gas stove, cheap. Call 872-2310. 2-11-2-2

FOR SALE - John Deere snow blower for lawn tractor, used 2 hours. Call 872-2592. 2-11-2-3

FOR SALE - Mortin free standing fireplace, new. Two 4-drawer file cabinets, electric Victor adding machine and Casio printing calculator. Call evenings 872-2588. 2-10-26-3

**NADARA'S**  
★ Grave Blankets (3 Sizes & Baby's) Stakes Included  
★ Grave Wreaths & Crosses  
★ Garland Wreaths (Any Size) Decorated Or Plain  
★ Novelty Trees, Canes & Stars  
★ Christmas Trees Colorado Blue, White Pine, Scotch Pine  
**5737 Murtz Rd. Cass City, MI**  
**Days 665-2241**  
**Evenings 872-3429** 2-11-2-4

NAME PINS, desk nameplates and plastic signs in various sizes made to your specification. For information and prices, contact Mrs. Buschlen at 872-2121, ext. 212. 2-2-17-1f

EXHAUST SYSTEMS - complete or partial systems. Stop in and we will be happy to give you a quote. Cass City Tire, phone 872-5303. Your headquarters for Cooper tires. 2-11-9-1

### Paul's Pump Repair

1/2 hp Myers shallow or deep well jet pump \$192  
1/2 hp submersible pumps \$336  
30 gallon bladder tank \$116  
42 gallon bladder tank \$137  
For prompt service anytime Call Paul at 673-4850 2-10-7-1f

FOR SALE - Electric clothes dryer, wooden rocking chair, fish shanty, chrome front bumper for pickup. Call 872-3567. 2-11-9-3

FOR SALE - highly customized S&W 1916 revolver, 45 Colt. Comes with original parts, holster, etc. Asking \$550 or will consider partial trade. See Steve at 6620 Houghton St., Cass City. Monday-Saturday 9:00-1:00 p.m. 2-11-9-3

Give a Gift Subscription to Cass City Chronicle  
• Birthday, Anniversary  
• Service personnel  
• College students  
Gift card sent with every order. 2-9-21-1f

**Household Sales**  
GARAGE SALE - Saturday and Sunday, 9:00 till 5:00. 6634 Third St. 14-11-9-1

### Real Estate For Sale

LISTINGS NEEDED - Call for free appraisal. Our experience is your insurance. Osentoski Realty, Cass City, phone 872-4377. 3-5-28-1f

FOR SALE - 4 BEDROOM home, 2 baths, gas hot water heat, insulated, remodeled, near schools, excellent location. \$42,000. Will look at offers. Call Betty Hammond 872-2009, agent Osentoski Realty. 3-10-19-4

MOBILE HOME - 12x56 2 bedroom, all set up in Huntsville Mobile Home Park. Immediate occupancy. \$6,250 with \$1,000 down and monthly payments \$127.00. Call 1-517-635-7551. 3-8-24-1f

HOUSE For Sale - Attractive 4 bedroom split level home, 3 acres, large deck, recently foreclosed, immediate possession. Priced for quick sale, will consider trade. 5864 McAlpin Rd., Gagetown, drive by then call owner, Ed Horn 800-292-1550. 3-8-17-1f

### For Rent

ROSECRANS Apartments in Gagetown - starting at \$265 month. Heat included, near public school. Call 517-665-2673. EHO 4-8-24-1f

GARAGE RENTAL space for one car for the winter. Call 872-4095. 4-10-26-3

GRANT APARTMENTS - in Owendale, starting at \$265 month. Heat included, near public schools. Call 517-678-4401. EHO 4-8-24-1f

FOR RENT - 1 bedroom apartment in Cass City, kitchen appliances, carpeting, drapes, storage, coin operated laundry. Equal Housing Opportunity. FmHA. Call Richard Smith 872-3610 after 6. 4-11-9-3

FOR RENT - 2 bedroom apartment, Northwood Heights. Phone 872-2369. 4-10-19-1f

### 20 Acres - 11,000 square foot Building!!!

SPECIAL!!! Investors, Developers and Business Purchasers: BUSINESS BUILDINGS: Showroom with 3 offices; parts room 60x60; WORKSHOP 50x108' - 6' concrete floor; 3 overhead doors; 3 phase electrical; Natural gas; approximately 11,000 square foot building - all situated on 20 Acres of land - many features - priced to sell at \$165,000.00. Highway location - edge of Cass City Limits.

See, Call or Write to:

### B.A. CALKA, REALTOR

6306 West Main Street  
Cass City, Michigan 48726  
Call 517-872-3355 or 872-3230 3-11-9-3

### REDUCED IN PRICE



CASS CITY

Think how delightful this home would be with pastel color and contrasting trim for windows, eaves and porch columns. Add some hanging plants across the front of the porch and be proud of your stately home. After buying home last year and installing new gas boiler and hot water heater, carpeting in dinette and kitchen and painting all the way through, the plans of the owner were changed. He will sacrifice at \$39,900. Inside it's a 4 bedroom, 2 bath house that had previously been remodeled with all new walls, well insulated, rewired and copper plumbing was installed. There is a part open stairway that adds charm to interior. See for yourself. Call now.

Office 872-4377

Betty Hammond 872-2009  
Joy Anthony 658-8246  
Ken Osentoski 872-2352  
Martin Osentoski 872-3252  
Walt Schobert 673-2735  
Judy Winter 673-5464  
Lee LaFave 665-2295  
Barbara Osentoski 673-7665  
David Osentoski 673-7777

## OSENTOSKI REALTY

AND AUCTIONEERING

Call 872-4377  
EQUAL HOUSING or if no answer 872-2352 3-11-9-1

**Mr. Farmer**  
Read and Use  
**CHRONICLE CLASSIFIED ADS**

- To sell or rent a farm
- To sell or buy livestock
- To sell or buy implements
- To profitably sell or buy anything

The Classified Section is Where Interested Prospects Look First

**The Cass City Chronicle**  
Phone 872-2010

## Find the Service or Product You Need in This... Action Guide SERVICE DIRECTORY

<p><b>AUTO SERVICE</b></p> <p><b>CASS CITY TIRE</b> Hercules and Cooper Tires • Tire Repair • Alignments • Mufflers • Brakes • Oil Changes Certified Mechanic Phone 872-5303</p> <p><b>BUILDING MATERIALS</b></p> <p><b>Craft-Clara Lumber, Inc.</b> Cass City - 872-2141 Anderson Windows Dexter Locks Prefinished Paneling Mon.-Fri. - 8 a.m.-5:30 p.m. Sat. - 8 a.m.-3 p.m.</p> <p><b>CARPET-LINOLEUM INSTALLATION AND REPAIR</b></p> <p>Buy your carpet or linoleum, then call us for expert installation. We also do custom and repair work. Factory trained, "We Do It Right." Satisfaction guaranteed. <b>J.J.'s Flooring Service</b> Cass City Phone 665-2686 or 872-4701</p> <p><b>FLOWERS</b></p> <p><b>Buds and Blossoms by Sandy</b> Flowers - Plants - Balloons Sandy &amp; Tom Tierney, Owners 4546 Leach St., Cass City, MI 48726 Phone 872-3935</p> <p><b>PEOPLE READ Little Ads</b> You're Reading One Now! Call 872-2010</p>	<p><b>PLUMBING-HEATING</b></p> <p><b>BULK TANKS</b> ALL SIZE CYLINDERS AND BULK TANKS AVAILABLE We Provide Our Customers With: • No minimum usage requirement • Discount to Budget Plan customers • Discount to Courtesy fill customers • Discount to customer owned tanks • Radio dispatched trucks • Interest Free Financing on appliances • Factory-Trained service technicians</p> <p><b>Fuelgas</b> Junction of M-53 and M-81 Cass City Phone 872-2161</p> <p><b>24-HR. SERVICE</b> <b>SHETLER</b> PLUMBING &amp; HEATING, INC. 6528 Main Phone 872-8084 Pigeon Phone 453-3531</p> <p><b>RUBBISH REMOVAL</b></p> <p><b>Rich's Disposal</b> Residential &amp; Commercial Rubbish Removal Container Service Available Call 683-2233</p> <p><b>RUST PROOFING</b></p> <p><b>Tuff-Kote Dinol</b> Automotive Rust Proofing Systems &amp; Waxing Gravel Guards Running Boards Rock Kote Stone Chip Protection Phone 269-9585 827 S. Van Dyke, Bad Axe</p>	<p><b>TYPING/TUTORING</b></p> <p><b>WRITE TOUCH</b> Professional/Customized Resumes Business Typing Word Processing Tutoring in reading and writing, certified teacher, Ellen Toner Phone 872-2506</p> <p><b>USED CARS</b></p> <p><b>FOR A USED CAR CALL TOM</b> 872-5020 Financing &amp; Service Contracts Available (Free Credit Checks)</p> <p>This space could be yours for as little as \$1.75 per week.</p> <p><b>WINDOW CLEANING</b></p> <p><b>SUPREME WINDOW CLEANING</b> • Storms-Screens-Windows • Janitorial Service • Floors, Eaves &amp; Gutters Cleaned • Hi-Riser Service &amp; Rental Estimates on Commercial, Residential &amp; Industrial Work Complete Insurance Coverage Security Services Available 1120 Gratiot, Saginaw Call 790-7609</p>
----------------------------------------------------------------------------------------------------------------------------------------------------------------------------------------------------------------------------------------------------------------------------------------------------------------------------------------------------------------------------------------------------------------------------------------------------------------------------------------------------------------------------------------------------------------------------------------------------------------------------------------------------------------------------------------------------------------------------------------------------------------------------------------------------------------------------------------------------------------------------------------------------------------------------------------------------------------------------------------------------------------------------------------	-------------------------------------------------------------------------------------------------------------------------------------------------------------------------------------------------------------------------------------------------------------------------------------------------------------------------------------------------------------------------------------------------------------------------------------------------------------------------------------------------------------------------------------------------------------------------------------------------------------------------------------------------------------------------------------------------------------------------------------------------------------------------------------------------------------------------------------------------------------------------------------------------------------------------------------------------------------------------------------------------------------------------------------------------------------------------	------------------------------------------------------------------------------------------------------------------------------------------------------------------------------------------------------------------------------------------------------------------------------------------------------------------------------------------------------------------------------------------------------------------------------------------------------------------------------------------------------------------------------------------------------------------------------------------------------------------------------------------------------------------------------------------------------------------------------------------------------------------------------------------------------------------------------------------------------

**New on the market**  
Stately built Cape Cod home on over 300 ft. on Cass River; 1/16 of a mile off blacktop road, 3-4 bedrooms, 2 baths, fireplace in living room - solar and oil heat. Full walk-out basement, partly finished - 3-10 acres of land. #CY788

**Retiree or Starter Home**  
2 bedrooms, large living room, den, 1st floor laundry room - natural gas heat - close to churches, downtown shopping - older garage - 1/3 of a basement. \$26,500.00. #TCC913

**Building Site**  
5 surveyed acres, less than 3 miles from Cass City. Natural gas, electric and telephone available. Possible terms. #A149

**Business opportunity**  
We have several to choose from. Restaurant, party stores, gas stations, rental properties. Call us today for more details! 2-9-21-1f

**Household Sales**  
GARAGE SALE - Saturday and Sunday, 9:00 till 5:00. 6634 Third St. 14-11-9-1

**Just South**  
1 bedroom down, 3 up - large country kitchen, 3 baths, dining room and parlor, 24'x32' attached garage - 24'x32' insulated tool shed - make offer. #CY777

**KELLY & CO. REALTY**  
6451 Main  
Call Cass City 517-872-2248 or Caro 517-673-2555  
Kelly W. Smith, Broker  
Farm - Commercial - Residential Listings Wanted!  
3-11-9-1

**UNDER CONSTRUCTION IN BEAUTIFUL NORTHWOOD ESTATES**

**Herron Builders, Inc.**  
3 Bedrooms - All Utilities - Ready to Move In  
High Efficiency Gas Furnace - Terms Available  
See Tom Herron  
Cass City 3-10-19-4 Phone 872-2217



# CALLING 872-2010 PUTS AN ACTION AD TO WORK FOR YOU

**For Rent** - very nice country home, 4 bedrooms, 2 baths, full basement, Gageton schools, \$395 per month, deposit and references required. Call Judy Winter, Osentoski Realty, 673-5464 mornings. 4-11-9-1

**For Rent** - one bedroom apartment in Cass City. Kitchen appliances, carpet, drapes, storage, coin operated laundry. Contact Richard Smith after 6 p.m., phone 872-3610. 4-11-2-4

**For Rent** - apartment, ideal for one person. Stove, refrigerator, carpeting, gas heat. Contact Bud Schneeberger at Schneebergers TV-Furniture, Appliance, Cass City. 4-10-12-1f

**For Rent** - Masonic Temple Refreshment Hall - parties, dinners, meetings. No alcoholic beverages. Call Ted Furness, 872-4509. 4-2-17-1f

**For Rent** - storage, Cass City Mini-Storage. Call 872-3917. 4-5-4-1f

**For Rent** - The Paint Store has a wallpaper steamer for easy removal of old wallpaper. Call 872-2445. 4-11-2-1f

**Notices**

**LAFAVE STEEL SUPPLY, INC.**  
For all your steel needs: fabricating, machine shop, welding, hydraulic hose accessories.  
8260 Van Dyke Rd., Cass City  
Phone 517 872-2581  
Monday thru Friday 8:00 till 5:00  
Saturday 8:00-noon. Closed for lunch 12:00-12:30. 5-10-19-1f

**Services**

Does your TV or VCR need to be repaired?  
Bring it to Rick's for fast dependable service  
**Rick's Earth Station**  
1433 E. Caro Rd., Caro  
Phone 673-4783 8-10-19-1f

**Services**

**RICH'S DISPOSAL** - Residential and Commercial Rubbish Removal. Container service available. Call 683-2233. 8-2-12-1f

**Help Wanted**

WANTED - appliance technician. Contact Bud Schneeberger, at Schneeberger TV, Furniture & Appliances, Cass City. 11-11-2-1f

WANTED - baby-sitter in my home in Cass City, 7:00 a.m.-4:00 p.m., no Sundays, preferably older lady. Inquire 6328 Pine. 11-11-9-1

## FOR SALE BY B.A. CALKA REAL ESTATE

**NEW LISTING:** In Cass City - EXECUTIVE HOME with over 3,000 square feet of living room - Large family size kitchen with Formal Dining Room - plus large FAMILY ROOM - 3 bathrooms; sewing room or office - Andersen windows throughout home; comes with all appliances - walk-out basement - extra large garage with electric door opener - has to be seen to be appreciated - Shown by appointment!! Lot is large and nicely landscaped - Call us for a personal showing of this fine home.

56 ACRES: 6 room home with 3 bedrooms; basement; home on a knoll with nice valley views; 32x50' pole type building with shop; muck and Miami loam; 1/4 acre pond 12' deep; furnace & hot water heater 2 yrs. old; Kingston-Mayville Area - priced to sell at \$61,000.00 - 20% down payment. L. #16,582

HUNTINGLAND & RECREATIONAL LAND --- 75 Acres - Isolated good hunting & camp area - small stream thru property; rolling hills; partridge, deer, rabbits and pheasants - offered for quick sale at \$30,000.00. Kingston Area. L. #16,581

BUILDING SITE: M-46 & near Vassar Golf Course - 1.77 acres - \$5500.00.

40 ACRES: Close in to Cass City - Ideal hunting & recreation land with good building site; site surrounded by trees - pond about 14' deep - old trailer house --- all this for \$30,000.00 with \$4,000. down payment. L. 16,583

**COLONIAL**  
IN CASS CITY: Two story aluminum sided home with approx. 2,000 square feet of living space; blown in insulation in ceiling and walls; open stairway; formal dining room; 4-5 bedrooms; 2 car garage; excellent location - near downtown Cass City - distant owner wants immediate sale. - Your inspection invited!!! Will help with financing. L#16,521

**SPECIAL!!** 1 1/2 story aluminum sided home - 3 bedrooms; new bathroom; new laundry room 1st floor; new carpeting; new heating system 4 years old - new roof; new electric water heater and new water pump; over \$10,000 spent on remodeling; nice yard for the children to play in - Pine trees, ideal for starter home or for Florida travelers that want reasonable priced home for the summer. All this for \$28,500, terms available to responsible parties. Immediate Possession. List. #16,580

**NEAR CASS CITY:** 2-1/4 ACRES: 1 1/2 story home with 4-5 bedrooms; all modern kitchen; aluminum siding; 1 1/2 bathrooms; Moncrief gas furnace with Energy-Mate wood furnace; formal dining room; many features - large 2 car garage; very neat in and out - situated on a knoll overlooking the country side - Your inspection invited - priced to sell. L. # 16,569-A

**NEAR CASS CITY:** 5 ACRES - Remodeled BRICK HOME with all new kitchen comes with appliances - 7 rooms - laundry room off kitchen; new circuit breaker box - many other features; large barn - situated on a knoll - attractive setting - blacktop road - Call us for a personal showing -- priced to sell. List. #16,575

1 MILE FROM CASS CITY - 1 7/8 Acres - RANCH TYPE HOME with 3 bedrooms; laundry room; gas furnace - very neat in and out - nicely landscaped - covered PATIO - garage with workshop - live stream - priced to sell at \$36,000. terms. L16,577

**RESIDENCE WITH OFFICE!!**  
IN CASS CITY: 1 1/2 story home with aluminum siding; in very good condition in and out; 3 bedrooms; 1 1/2 bathrooms; basement; formal dining room; PLUS OFFICE with FIREPLACE - 2 piece ceramic bathroom; suitable for Real Estate, etc., special features: SPRINKLING SYSTEM AND CENTRAL AIR - Conditioning - extra large lot 132x132' - VACANT - Immediate Possession upon closing. Listing #16,571

14 ACRES - 2 1/2 miles south of Cass City - comes with 12x50' mobile home sitting on a slab - 68' deep well with own water system - septic tank - 15x15' storage building - 6-7 acres wooded - horse barn - priced to sell at \$16,000.00. Listing #16,500

10 ACRES - Beautiful building site; lots of Pine & Birch trees - live stream on property -- reduced from \$14,900 to \$12,900. terms. L#16,474

IN CASS CITY: 4 bedroom home with 1 1/2 bathrooms; forced hot water furnace; lots of storage room; large kitchen; dining room; comes with 2 LOTS - close to downtown Cass City - walking distance to playground, schools, churches, etc. DISTANT OWNERS want quick sale --- IMMEDIATE POSSESSION --- Sellers will hold land contract. Asking \$49,900. Terms. #16,285

HUNTING LAND: We have several parcels available - 40 acres, \$28,000, adjoining state land. ---40A---Pond \$30,000.

RETIREES: One story stone home with 2 bedrooms; forced hot air furnace; laundry room; all modern kitchen; carpeted; large barn for storage or horses - all this on 3 1/2 acres and close to Cass City. Priced to sell immediately at \$29,500. #16,565

**GAGETOWN!!**  
Ranch home with 3 large bedrooms; lots of closets and storage; large family size kitchen with Kitchen-Aid dishwasher; built-in china and desk; laundry room off kitchen; 2 bathrooms; 2 car garage attached; IMMEDIATE POSSESSION, \$38,500. L#16555

Medical Building - well constructed - suitable for Dentist, Doctor, CPA, Attorney, Insurance or Real Estate Office - Priced to sell - Immediate Possession. L#16,451

**HUNTERS SPECIAL!!!**  
40 ACRES close to Cass City - surveyed and perked --- will sell each 10 acres for \$7500.00 or \$22,500 on 40 Acres; get a group together and buy the 40 ACRES - HUNTING OR BUILDING sites --- Call or see B.A. Calka, Realtor, or Marv Hobart, Associate Realtor, at 6306 W. Main St., Cass City, Michigan 48726, (517) 872-3355.

OWENDALE: 2 story frame home with lots of Oak trim; Oak stairway; 3-4 bedrooms; 2 bathrooms; dining room; basement; 2 car garage - could easily be converted into 2 INCOMES - \$20,000.00 --- to settle estate. Possession on short notice. L. #16,573.

**COUNTRY HOME ON 2 ACRES!**  
Room for horses in Barn!!  
NEAR CASS CITY: Very neat 3 bedrooms with closets - 2 bathrooms; new well; extra large kitchen - extra large living room with sliding glass door leading to sun deck; many other features - small horse barn for 3 horses; nicely landscaped -- Asking only \$45,000. terms. L#16,493.

**LISTINGS NEEDED ON ALL TYPES OF REAL ESTATE (BUYERS WAITING)**  
14 ACRES: Cass City - Owendale --- large 4-5 bedroom home - basement; 1 1/2 bathrooms; large barn with new roof; room for several horses, etc. Immediate Possession. Priced to sell. L#16,568.

See, Call or Write to:

## B.A. CALKA, REALTOR

6306 West Main Street  
Cass City, Michigan 48726

B.A. Calka, Realtor  
Marv Hobart, Associate Broker

**Call 517-872-3355**  
Ask For Free Folders

Our 36th year serving Tuscola, Sanilac and Huron Counties

**UNIONVILLE Apartments** - in Unionville, starting at \$260 month. Heat included, near public schools. Call 517-674-2904. EHO 4-8-24-1f

**FOR RENT** - storage, Cass City Mini-Storage. Call 872-3917. 4-5-4-1f

**FOR RENT** - The Paint Store has a wallpaper steamer for easy removal of old wallpaper. Call 872-2445. 4-11-2-1f

**CASS CITY Apartments** are located in Cass City, MI. We are a Farmers Home Administration senior community and are presently maintaining a waiting list for occupancy. If you are currently on our waiting list and wish to update your application or you would like information about our apartments, please call 872-2009 between 9 a.m.-5 p.m. Equal Housing Opportunity. 4-11-9-3

**FOR RENT** - newly remodeled business space in prime location in Cass City. Phone 872-4377 or 872-2352 evenings. 4-7-31-1f

**OPENING** - furnished home for 2 senior citizens. Kitchen privileges or meals and laundry furnished extra. Call 872-4213. 4-11-2-3

**FOR RENT** - one bedroom apartment, \$195 per month plus deposit. Call 872-3731. 4-11-9-3

**FOR RENT** - 2 bedroom apartment, \$225 per month plus deposit. Call 872-3731. 4-11-9-3

**FOR RENT** - office space, located 8260 N. Van Dyke, 3 1/2 miles north of M-81 on M-53. 10x14 - \$105 per month. 14x16 - \$165 per month including utilities. Call 517-872-2581. 4-11-9-1f

**FOR RENT** - one bedroom apartment, partially furnished. Includes utilities, heat, water and sewage. \$275 per month, plus security deposit. 2nd floor. Call 872-2691. 4-10-26-3

**20TH ANNUAL KOUNTRY KITCHEN Bazaar, Bake Sale, Luncheon**  
Saturday, Nov. 12 10 a.m.  
Diabetic baked goods, decorated sweatshirts, quilt, baskets, Christmas decorations, wood crafts.  
TRINITY UNITED METHODIST CHURCH  
Houghton and Seeger St.  
Cass City 5-11-2-2

**SCRATCH PADS** - Excellent stocking stuffers. At The Chronicle. 5-10-26-4

**LADIES VFW Bazaar & Bake Sale**  
Lunch served  
SATURDAY, NOV. 12 9:00-5:00  
VFW Building, Main St., Cass City  
Tables to rent for crafters - call 872-3094 or 872-2057 5-11-2-2

**OIL CHANGES** - We perform quality service with Pennzoil products. We take time to check your car. Some are cheaper but none are better. See us today, at Cass City Tire, phone 872-5303. 5-11-9-1

**Notices**

**CHAPELO SHOE SERVICE**

PICK UP STATION AT  
Cass City Tire  
Main St., Cass City  
5-11-9-4

**FOUND** - bird dog - must identify. Call 872-2959. 5-10-26-3

St. Agatha Parish Breakfast  
**SUNDAY, NOV. 13**  
10 a.m.-1:00 p.m.

**IN CHURCH BASEMENT GAGETOWN**  
All you can eat  
Adults \$3.00  
Children \$1.00  
Children free - 5 & under  
5-11-9-1

**CASH** - Have you sold your property on a land contract or mortgage and now you would like the cash? MDL Investments, ask for Mike, 872-4555. 5-6-29-1f

**Wedding**

Invitations and Announcements for all social occasions

Catalog loaned overnight

Matching accessories including matchbooks, napkins, thank you notes

Cass City Chronicle  
Phone 872-2010

**THANK YOU, ST. JUDE** - May the Sacred Heart of Jesus be adored, glorified and preserved throughout the world, now and forever. Sacred Heart of Jesus, pray for us. St. Jude, worker of miracles, pray for us. St. Jude, help of the hopeless, pray for us. Say this prayer nine times a day; by the eighth day, your prayers will be answered. (Publication must be promised.) 5-11-9-1

**BINGO** - every Wednesday night. Open 6:00-early bird 6:30 - regular bingo 7:00. Post 3644 VFW, E. Main St. 5-2-26-1f

**20TH ANNUAL KOUNTRY KITCHEN Bazaar, Bake Sale, Luncheon**  
Saturday, Nov. 12 10 a.m.  
Diabetic baked goods, decorated sweatshirts, quilt, baskets, Christmas decorations, wood crafts.  
TRINITY UNITED METHODIST CHURCH  
Houghton and Seeger St.  
Cass City 5-11-2-2

**SCRATCH PADS** - Excellent stocking stuffers. At The Chronicle. 5-10-26-4

**LADIES VFW Bazaar & Bake Sale**  
Lunch served  
SATURDAY, NOV. 12 9:00-5:00  
VFW Building, Main St., Cass City  
Tables to rent for crafters - call 872-3094 or 872-2057 5-11-2-2

**OIL CHANGES** - We perform quality service with Pennzoil products. We take time to check your car. Some are cheaper but none are better. See us today, at Cass City Tire, phone 872-5303. 5-11-9-1

**NO HUNTING SIGNS**  
Red & black ..... 25¢ ea.  
5 for \$1.00  
\*\*\*\*\*  
Black ink ..... 20¢  
2.....35¢  
8.....\$1.00  
CASS CITY CHRONICLE  
5-9-21-3

**TOASTY WARM** sweat-suits and sweaters at George's in Cass City. Sizes 36-48. 5-11-9-1

**PIANO LESSONS** - given in my home - fall and winter scheduling. Marcia Merchant, phone 872-4563. 5-11-2-3

**THINK CHRISTMAS**  
A gift subscription to the Chronicle for a year is an ideal gift!  
Beautiful greeting card announces your gift.  
Call 872-2010  
CASS CITY CHRONICLE  
5-10-26-6

**BINGO** - Every Thursday at St. Pancratius Hall, S. Seeger, Cass City. Doors open 6:00 p.m. Early-bird 6:30, regular bingo 7:00. Phone 872-5410. Knights of Columbus Council No. 8892. 5-12-31-1f

**Services**

Does your TV or VCR need to be repaired?  
Bring it to Rick's for fast dependable service  
**Rick's Earth Station**  
1433 E. Caro Rd., Caro  
Phone 673-4783 8-10-19-1f

**INTERIOR AND EXTERIOR** painting. Theron Eskilsen, 4355 Ale St., Cass City. Call 872-3095. 8-4-2-1f

**Arthur Brown Cass City Well Drilling and Pump Repair**  
STATE LICENSED  
Phone 673-3800 8-1-27-1f

**Simpson Excavating**  
Sand - Gravel - Fertile black dirt - Septic Systems - Ditch cleaning - Water lines - Driveways - Basements.  
This and That  
FREE ESTIMATES  
Call 872-4502 8-5-25-1f

**THUMB AREA** wallpapering and interior painting. For quality work at reasonable rates, call today 872-2609 8-11-2-2

**REVIVE**  
CARPET & UPHOLSTERY CLEANING  
Free estimates  
Truck mounted equipment  
Auto interior  
Commercial  
Reasonable rates  
Flooding  
Don Dohn  
4394 Maple #3  
Cass City  
872-3471  
8-4-15-1f

**Chuck O'Dell Excavating**  
Septic systems installed and cleaned  
sand - gravel - ponds  
ditching - hydrachoe - dozer  
backhoe  
Phone (517) 872-3031  
4323 Krapf Rd.  
Cass City, Michigan  
8-6-3-1f

**JOHNSON'S SEPTIC TANK** - cleaning - available 7 days. No charge mileage. Portable toilet rental available. Call 269-8097. 8-5-25-1f

**CUSTOM SLAUGHTERING**  
**BEEF-PORK-VEAL-LAMB CURING, SMOKING AND PROCESSING**  
TUESDAY & FRIDAY  
Erla  
Packing Co., Inc.  
USDA Plant 1074  
Cass City 517-872-2191  
8-4-9-1f

**AUCTIONEERING** - see Lorn "Slim" Hillaker. Top dollar for your property. Phone 872-3019, Cass City. 8-10-3-1f

**Smith Refrigeration and Appliance Repair**  
All makes and models  
Call 872-3092 8-10-22-1f

**Ken Martin Electric, Inc.**  
Homes - Farms  
Commercial  
Industrial  
New and rewire  
State Licensed  
Phone 872-4114  
4180 Hurds Corner Road  
8-8-10-1f

**For Fast, Efficient Repairs on your Satellite System**  
Call Rick's Earth Station  
1433 E. Caro Rd.  
Caro. Phone 673-4783. 8-10-19-1f

**ELECTRIC** motor and power tool repair, 4 p.m. to 8 p.m. weekdays, 8 a.m. to 5 p.m. Saturdays. John Blair, 1/8 mile west of M-53 on Sebawing Road. Phone 269-7909. 8-12-13-1f

**Wanted to Buy**  
WANTED - windmill and pump. Cass City area. Call 872-3552. 6-11-2-3

WANTED - silver coins, dimes, quarters, halves 1964 and back - silver dollars 1878 to 1935. Paying top price. The Coin Shop, 6439 Main. Phone 872-3919. 6-9-21-1f

**To Give Away**  
FREE - male Brittany Spaniel, 4 years old, good bird hunter. Call 872-4153. 7-11-9-1

FREE - puppies to give away, Lab and Spaniel mix. Call 872-2695. 7-11-2-3

FREE - puppy, female, 6 weeks old, mother - Shepherd. Call 872-4103. 7-11-9-1

**TO GIVE AWAY** - 8 puppies, mother is Chow, Labrador. Call after 4:00 p.m., 872-4522. 7-10-26-3

FREE to anyone who will give him lots of love and attention, medium size black and white male dog. House broken. Call 872-3638. 7-11-9-1

**Livestock**  
FOR SALE - 2 young Suffolk ewes, 1 ram, special price 4-H members. Also aged Arabian stallion - cheap to good home. Call 269-8803. 10-10-26-3

**Help Wanted**  
**Accounting Clerk**  
General Cable Co. has an immediate opening for an accounting clerk. This position will be responsible for a variety of accounting duties including accounts payable, inter-plant receipts, account reconciliation, etc. Applicants must have accounting education and training beyond high school and have at least 2 years' accounting experience. Send resume or apply in person:  
**GENERAL CABLE CO.**  
6285 Garfield St.  
Cass City, MI 48726  
Attn. J. E. Cooper,  
Employee Relations Manager  
An Equal Opportunity Employer M/F/H 11-11-9-2

**Work Wanted**  
WILL BABY-SIT in my home, ask for Karen, 872-2725. 12-11-9-3

WILL BABY-SIT in my home Monday thru Friday. Have 2 children. Phone 872-2979, ask for Pam. 12-10-26-3

**Card of Thanks**  
THE FAMILY OF Ernest Hyatt would like to thank the Marlette Hospice, Little's Funeral Home, friends and neighbors, Rev. Ken Proctor, Dale and Faye Bullock, the people of Mizpah Church for the lovely luncheon, those who called, sent flowers, cards, food and all the other kindnesses you did. We really appreciate all of your thoughtfulness and prayers. 13-11-9-1

WE WISH TO express our thanks and appreciation for the prayers, cards, memorials, calls, food, flowers, visits and many acts of kindness shown during the loss of our beloved husband, father and grandfather. A thank you to Rev. William Bollinger and Rev. Sam Mills for their prayers, the ladies of Deford United Methodist Church for the beautiful luncheon, the Colton Funeral Home for sympathy and understanding. A special thank you to the staff at the Tuscola County Medical Care Facility for the wonderful care and kindness he was given. Your thoughtfulness will always be remembered. The family of Elmer Vandemark. 13-11-9-1

**Accounting Clerk**  
General Cable Co. has an immediate opening for an accounting clerk. This position will be responsible for a variety of accounting duties including accounts payable, inter-plant receipts, account reconciliation, etc. Applicants must have accounting education and training beyond high school and have at least 2 years' accounting experience. Send resume or apply in person:  
**GENERAL CABLE CO.**  
6285 Garfield St.  
Cass City, MI 48726  
Attn. J. E. Cooper,  
Employee Relations Manager  
An Equal Opportunity Employer M/F/H 11-11-9-2

**Work Wanted**  
WILL BABY-SIT in my home, ask for Karen, 872-2725. 12-11-9-3

WILL BABY-SIT in my home Monday thru Friday. Have 2 children. Phone 872-2979, ask for Pam. 12-10-26-3

**Card of Thanks**  
THE FAMILY OF Ernest Hyatt would like to thank the Marlette Hospice, Little's Funeral Home, friends and neighbors, Rev. Ken Proctor, Dale and Faye Bullock, the people of Mizpah Church for the lovely luncheon, those who called, sent flowers, cards, food and all the other kindnesses you did. We really appreciate all of your thoughtfulness and prayers. 13-11-9-1

WE WISH TO express our thanks and appreciation for the prayers, cards, memorials, calls, food, flowers, visits and many acts of kindness shown during the loss of our beloved husband, father and grandfather. A thank you to Rev. William Bollinger and Rev. Sam Mills for their prayers, the ladies of Deford United Methodist Church for the beautiful luncheon, the Colton Funeral Home for sympathy and understanding. A special thank you to the staff at the Tuscola County Medical Care Facility for the wonderful care and kindness he was given. Your thoughtfulness will always be remembered. The family of Elmer Vandemark. 13-11-9-1

**Accounting Clerk**  
General Cable Co. has an immediate opening for an accounting clerk. This position will be responsible for a variety of accounting duties including accounts payable, inter-plant receipts, account reconciliation, etc. Applicants must have accounting education and training beyond high school and have at least 2 years' accounting experience. Send resume or apply in person:  
**GENERAL CABLE CO.**  
6285 Garfield St.  
Cass City, MI 48726  
Attn. J. E. Cooper,  
Employee Relations Manager  
An Equal Opportunity Employer M/F/H 11-11-9-2

**Work Wanted**  
WILL BABY-SIT in my home, ask for Karen, 872-2725. 12-11-9-3

WILL BABY-SIT in my home Monday thru Friday. Have 2 children. Phone 872-2979, ask for Pam. 12-10-26-3

**Card of Thanks**  
THE FAMILY OF Ernest Hyatt would like to thank the Marlette Hospice, Little's Funeral Home, friends and neighbors, Rev. Ken Proctor, Dale and Faye Bullock, the people of Mizpah Church for the lovely luncheon, those who called, sent flowers, cards, food and all the other kindnesses you did. We really appreciate all of your thoughtfulness and prayers. 13-11-9-1

WE WISH TO express our thanks and appreciation for the prayers, cards, memorials, calls, food, flowers, visits and many acts of kindness shown during the loss of our beloved husband, father and grandfather. A thank you to Rev. William Bollinger and Rev. Sam Mills for their prayers, the ladies of Deford United Methodist Church for the beautiful luncheon, the Colton Funeral Home for sympathy and understanding. A special thank you to the staff at the Tuscola County Medical Care Facility for the wonderful care and kindness he was given. Your thoughtfulness will always be remembered. The family of Elmer Vandemark. 13-11-9-1

**Accounting Clerk**  
General Cable Co. has an immediate opening for an accounting clerk. This position will be responsible for a variety of accounting duties including accounts payable, inter-plant receipts, account reconciliation, etc. Applicants must have accounting education and training beyond high school and have at least 2 years' accounting experience. Send resume or apply in person:  
**GENERAL CABLE CO.**  
6285 Garfield St.  
Cass City, MI 48726  
Attn. J. E. Cooper,  
Employee Relations Manager  
An Equal Opportunity Employer M/F/H 11-11-9-2

**Work Wanted**  
WILL BABY-SIT in my home, ask for Karen, 872-2725. 12-11-9-3

WILL BABY-SIT in my home Monday thru Friday. Have 2 children. Phone 872-2979, ask for Pam. 12-10-26-3

## Owendale woman hurt in accident

An Owendale motorist was treated and released from Hills and Dales General Hospital Friday after her southbound vehicle was struck by another vehicle at the intersection of Cemetery and Bay City-Forestville roads.

According to Tuscola County Sheriff's deputies, Ruth I. Jaworski, 5511 Canboro Rd., Owendale, stopped at the intersection and then continued south at about 6:30 a.m. when her vehicle was hit by a westbound vehicle driven by Marcus T. Osantowski of Ubyly.

Jaworski's vehicle sustained light damage and Osantowski's vehicle sustained moderate damage, according to reports, which state Osantowski was cited for failing to yield.

A Pontiac man was arrested on suspicion of operating a motor vehicle while under the influence of liquor early Saturday morning in Wells Township.

John R. Dowling, 28, was observed driving in the wrong traffic lane on Bevens Road near Murray Road at about 2:40 a.m., reports state.

In another traffic related arrest, Michael R. Dadacki, 27, 4063 Shaw Rd., Kingston, was taken into custody Friday evening in Gagetown for operating a motor vehicle while his license was suspended.

Deputies stopped

Dadacki's vehicle, which had no license plate light, at State and Lincoln streets at about 7:56 p.m.

Also reported were several car-deer accidents.

Kingston motorist Harold J. Harp, 4165 White Creek Rd., escaped injury Saturday when his northbound vehicle slid sideways on Kingston Road south of Bevens Road and rolled over after Harp attempted to avoid hitting a deer.

Harp's vehicle sustained extensive damage in the 2:05 p.m. mishap. He was cited for no proof of registration.

Renee Mallory, 4160 S. Elkton Rd., Gagetown, reported hitting a deer Friday while driving east on Cass City Road east of McGregory Road in Elmwood Township. Her vehicle was slightly damaged in the 5:40 p.m. mishap.

Swartz Creek resident Kenneth R. Lockrey was driving south on Cemetery Road north of Merchant Road in Elkland Township Friday afternoon when his vehicle struck a deer. Light damage was reported in that accident.

Also Friday, Wade A. Smith, 2500 S. Phillips Rd., Kingston, reported hitting a deer at about 5:45 a.m. while driving north on Cemetery Road south of Shabbona Road in Novesta Township. Smith's vehicle sustained moderate damage.

## Traffic solution sought

Continued from page one.

one of the 99 Doerr Road vehicles waited that long to leave the stop sign."

"Installing a traffic signal is not going to reduce the present waiting time at Doerr Road," he concluded.

Contacted Friday, Van Hinc said he has agreed to make another observation in Cass City. He added, however, that it isn't likely traffic at the intersection has increased drastically enough to consider a traffic signal.

He explained that in order for an intersection to be considered for a signal, there would have to be a traffic flow of 140 vehicles per hour for at least 8 hours daily.

He added, "Traffic lights generally cause a lot more trouble" than they resolve.

Cass City Police Chief Gene Wilson suggested that measures other than installing a light, such as increasing street lighting and extending speed limits, might be more feasible, considering that traffic at the intersection is heavy only at certain times of the day.

"I would say the worst times are between 8 and 8:30 a.m. and 3 and 4:30 p.m.," he said, adding "cruising" also has contributed to traffic congestion at the west end of the village.

# '88 Apportionment Report indicates tax bills going up

### ELKLAND TOWNSHIP

In Elkland Township, where the SEV rose by nearly \$2 million, residents living in the Cass City School District will pay taxes on 43.1770 mills, an increase of 3.027 mills over 1987.

Township residents living in the Owen-Gage School District will be assessed 56.8159 mills, an increase of .6802 mills.

### ELLINGTON TOWNSHIP

Caro School District residents living in Ellington Township are to be assessed a total of 46.09 mills (31.02 mills 12-1-88 and 15.07 mills 7-1-88). The 1988 millage rate is up by 4.09 mills.

Cass City School District residents living in the same township, meanwhile, will pay taxes on 46 mills, an increase of 6.1 mills over 1987.

The SEV in Ellington Township fell by \$25,383 in 1988.

### ELMWOOD TOWNSHIP

In Elmwood Township, where the SEV dropped by nearly \$2.5 million, those living in the Caro School District will be assessed 44.09 mills, compared to the 1987 rate of 42.99 mills.

Cass City School District residents and those living in the Goslin property district will pay on 44 mills, up by 3.1 mills over the 1987 rate.

Those township residents living in the Owen-Gage School District will be assessed 57.6389 mills, compared to 56.8857 mills in 1987.

### NOVESTA TOWNSHIP

In Novesta Township, all of which is in the Cass City School District, the total tax bill will be based on a levy of 42.5 mills, up by 3.1 mills over the 1987 rate of 39.4 mills. The township's SEV fell by nearly \$1 million in

1988.

The Cass City School District also includes portions of 4 other townships.

Almer Township residents living in the district will pay on 44 mills, compared to 40.4 mills in 1987; Columbia Township residents (including those living in the

Goslin property district) will be assessed 44 mills, compared to 40.9 mills; Kingston Township residents will pay on 42.5 mills, compared to 39.4 mills, and Wells Township residents will be assessed 42.3419 mills, compared to 39.2406 mills in 1987.

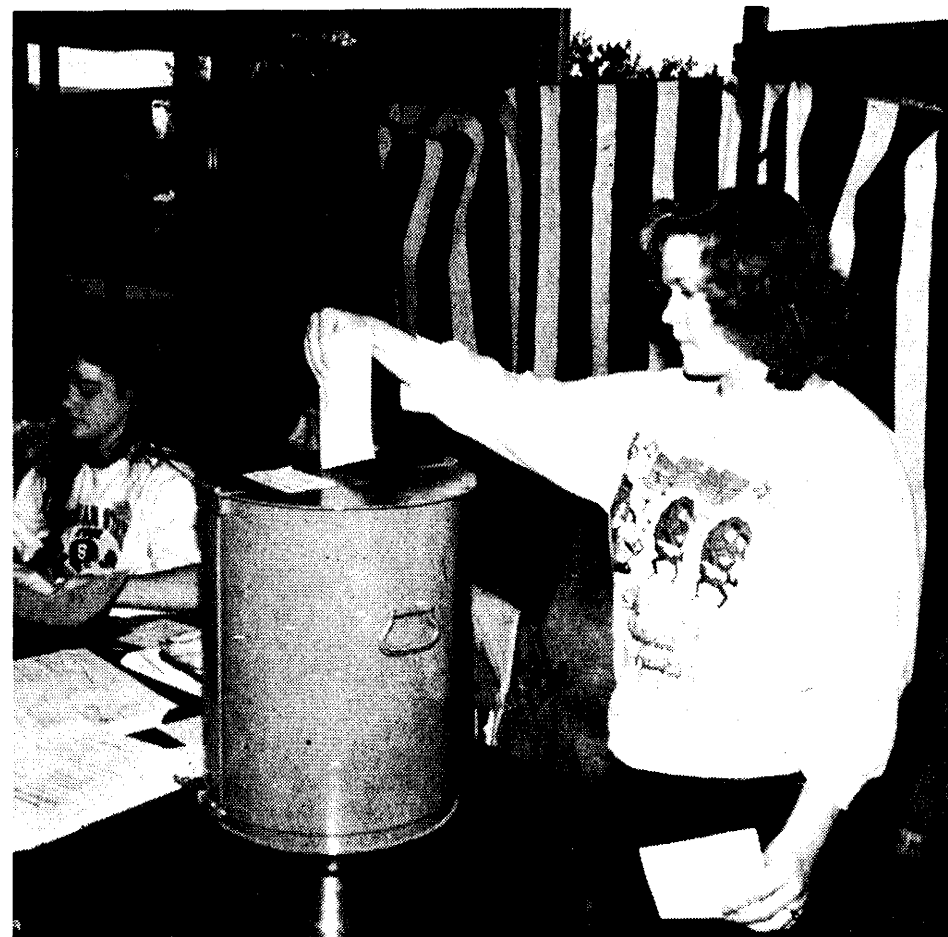

SENIOR JANET KOCH deposits her ballot after voting in a national mock election last week at Cass City High School. Koch was one of several students and staff members who cast ballots. The local results included George Bush over Michael Dukakis (175-53), Don Riegle over Jim Dunn (120-106), Bob Traxler over Lloyd Buhl (132-38), and the approval of all 4 state proposals.

## Novesta property taxes to increase?

Novesta Township Board members learned Monday that residential property taxes in the township are expected to go up by 15 percent following the next assessment.

Township Supervisor William C. O'Dell said the news isn't official yet, but added a letter from the Tuscola County Equalization Department indicates there will be a raise in residential property based on sales this past year.

In other business during the monthly meeting, board members examined the township's junk ordinance.

Township Clerk Nurse L. Kloc reported there are several old junk cars scattered throughout the township. She said letters will be sent to persons who are in violation of the junk ordinance.

The completion of painting at the Township Hall Monday marked the end of an estimated \$10,500 renovation of the hall, Kloc noted. She also pointed out that Monday's meeting was the last in which O'Dell will serve as township supervisor. O'Dell, who did not seek reelection this year, has been supervisor for some 12 years.

## Elkland board okays request

An application for P.A. 116 was approved during a brief monthly meeting of the Elkland Township Board Monday night.

Township Clerk Norma Wallace said the application, from Donald Shagene, is for 76.09 acres in section 3 of the township, located north of Cass City.

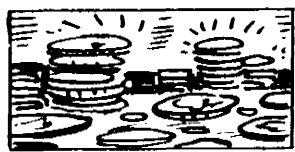

Coins cannot be made of pure gold or silver because they are not durable and wear out rapidly unless alloyed with another metal.

Because of declining land values, the Tuscola ISD, which levies 4.5 mills, will collect \$76,000 less next year. The Huron ISD will collect on 2.65 mills and the Sanilac ISD, 3.15 mills.

Tuscola County, meanwhile, will collect some \$2.36 million for general operations. That figure represents a decrease of \$80,000 from last year, when the county's state equalized valuation totaled \$581,024,066, compared to \$561,962,317 this year. The county's peak SEV came in 1985 at \$700,281,856.

Also to be collected by the county next year will be \$280,981 for bridge construction and an equal amount for operation of the Medical Care Facility, \$112,392 for senior citizen programs, and \$505,766 for the sheriff's road patrol. The 1988 county bridge and medical care millages will each net about \$10,000 less than a year ago.

## Fiddlers' jamboree set Nov. 12

A Fiddlers' Jamboree and Old-Fashioned Square Dance will be held at the Deckerville Elementary School Saturday, Nov. 12, from 1 until 11 p.m.

All old-time fiddlers, musicians with non-electrified instruments and square dance callers are welcome to participate.

The Jamboree will last from 1 until 5 p.m.; the square dance from 7 until 11 p.m.

A supper will be available from 5 until 7 p.m. Tickets are \$2 and good for the entire day; musicians are admitted free.

Proceeds will benefit the Museum of Arts and History's Traditional Music Programs. For more information, call (313) 982-0891.

## THE BEST USED CARS ARE WHERE YOU FIND THE BEST NEW CARS.

1988	PONT BONN LE 4 DR MAROON	\$11495
1988	PONT BONN LE 4 DR DRK BLUE	11495
1987	CHEVROLET PICK UP TT PNT	12995
1986	CHEV SUBURBAN TT BL & SILV	11995
1986	GMC RALLY VAN TT BLUE	7995
1986	BUICK ELECTRA T-TYPE SILV	10495
1986	PONTIAC GRAND AM 2 DR GRAY	6995
1986	FORD ESCORT 2 DR. BLK SIL	3895
1986	FORD ESCORT 4 DR. TAN	4495
1986	BUICK CENTURY 4 DR SILVER	7795
1986	BUICK CENT CUST 4 DR LT BLU	5495
1986	PONT GRAND AM 2 DR RED	7995
1985	OLDS CUTLASS SUP 2 DR CHRCL	7995
1985	DODGE LANCER 4 DR SILVER	3495
1985	PONTIAC 6000 2 DR GOLD	3495
1985	GMC SAFARI TT GREY	9795
1984	PONTIAC T1000 4 DR BRWN	2495
1984	ELECTRA EST WAG WDGRAIN	7995
1984	BUICK LESABRE 4 DR DRK BLUE	6695
1984	CHEV CAV TYPE 10 2 DR BRWN	2295
1983	CHEV 3/4 TON VAN BLUE	4995
1983	PLYMOUTH RELIANT 4 DR RED	1995
1982	GMC 1/2 TON PICKUP BLUE	3895
1982	BUICK LESABRE 4 DR GREEN	2495
1982	MERCURY ZEPH 4 DR TT Brown	3195
1982	DODGE 400 2 DR LT BLUE	2995
1981	PONTIAC LEMANS 2 DR SILVER	1495
1980	CHEVROLET BEAUVILLE VAN	2995
1979	CHRYSLER 4 DR GOLD	895
1979	CHEV MALIBU 2 DR BLACK	1795

\* Sale price includes factory rebate - Just add tax and license

## HOWARD BELL, INC.

### BUICK - PONTIAC - GMC

M-24 Frank St.

Caro

673-6126

The Want Ads Are Newsy Too!



## MONEY YOU WANT WITH EASY FLEXIBLE TERMS

See Us For All Your Loan Needs!

### The Cass City State Bank

Cass City, MI 48726  
MEMBER FDIC



# Cass City IGA Foodliner

6121 Cass City Road, Cass City, Michigan 48726  
Phone: 872-2645



Store Hours: Mon.-Wed.: 8:30 to 7; Thurs. & Fri.: 8:30 to 9; Sat.: 8:30 to 6; Closed Sunday.

★ Beer ★ Wine ★ Pkg. Liquor ★ Lottery Tickets ★ Food Stamps ★ W.I.C. Coupons ★ Bakery ★ Deli ★

Attention Getting

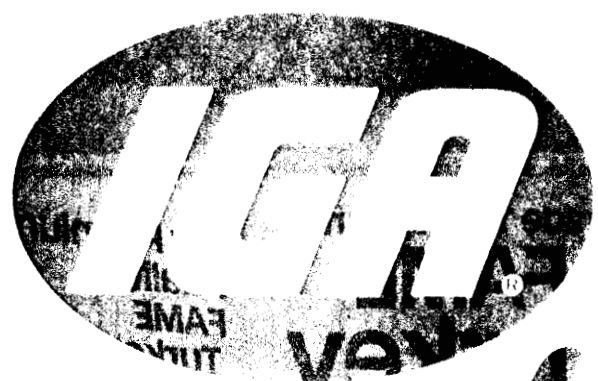

# Bake Sale!



**IGA COUPON**

Light Brown or Powdered  
**FAME Sugar**

**.39**

Limit 2 - 16 oz. Poly Bag

Limit one coupon per family. Coupon and \$15.00 purchase required, excluding tobacco, alcoholic beverages, or other coupon items. Coupon expires Sat., Nov. 12, 1988.

NR 160-1

**IGA COUPON**

Grade 'A' Large  
**FAME Eggs**

**.39**

Limit 1 - Dozen Ctn.

Limit one coupon per family. Coupon and \$15.00 purchase required, excluding tobacco, alcoholic beverages, or other coupon items. Coupon expires Sat., Nov. 12, 1988.

NR 159-2

**IGA COUPON**

All Chocolate Varieties  
**Nestle's Morsels**

**1.49**

Limit 1 - 10-12 oz. Pkg.

Limit one coupon per family. Coupon and \$5.00 purchase required, excluding tobacco, alcoholic beverages, or other coupon items. Coupon expires Sat., Nov. 12, 1988.

NR 158-3

Ad good for week ending Sat., Nov. 12, 1988.

NOTE: Not responsible for errors in printing. QUANTITY RIGHTS RESERVED.



Family Size  
**Betty Crocker  
Brownie  
Mix**  
21.5 oz. Pkg.  
**.88**



Quality  
**FAME**  
1/2% Lowfat  
**Milk**  
Gallon Jug  
**1.39**

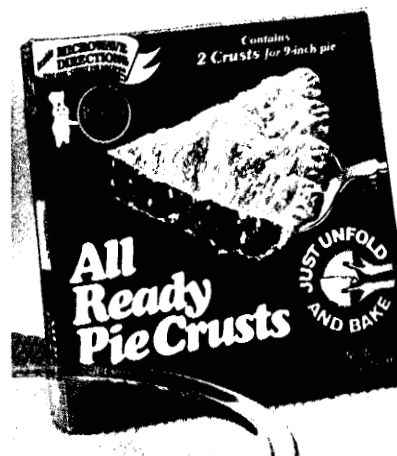

Pillsbury  
**All-Ready  
Pie  
Crusts**  
15 oz. Pkg.  
**1.39**



**FAME**  
All-Purpose  
**Flour**  
5 lb. Bag  
**.79**



In The Produce Dept...  
**Bulk  
Walnut  
Meats**  
For Fall Baking...  
**1.89** lb.



Sweetened  
**Eagle Brand  
Condensed  
Milk**  
14 oz. Can  
**1.39**



Mello Yello,  
Tab, Sprite, Minute Maid, Caffeine Free, Classic,  
Reg., Diet or Cherry  
**Coca-Cola**  
Limit 2,  
Please  
8 Pack -  
1/2 Liters  
**1.99**  
Plus Deposit



# 10 lb Meat Sale



IGA TABLERITE®  
**Pork Steak**  
**12.90** 10 lbs.  
Smaller Quantities At 1.59 lb.

IGA TABLERITE®  
**Fryer Breasts** ..... 10 lbs. **15.90**  
Smaller Quantities At 1.89 lb.

Skinless  
**FAME Hot Dogs** ..... 10 lbs. **7.90**  
Smaller Quantities At .99 - 1 lb. Pkg.

IGA TABLERITE®  
**Ground Beef From Chuck** ..... 10 lbs. **13.90**  
Smaller Quantities At 1.59 lb.

Mr. Turkey  
**Ground Turkey** ..... 10 lbs. **9.90**  
Smaller Quantities At 1.19 lb.

Bulk Breaed  
**Chicken Nuggets** ..... 10 lbs. **13.90**  
Smaller Quantities At 1.59 lb.

Bulk Breaed  
**Veal Patties** ..... 10 lbs. **8.90**  
Smaller Quantities At 1.09 lb.

Bulk Breaed  
**Chicken Patties** ..... 10 lbs. **11.90**  
Smaller Quantities At 1.39 lb.

Breaed  
**Fish Sticks or Portions** ..... 10 lbs. **11.90**  
Smaller Quantities At 1.39 lb.

IGA TABLERITE® -Beef  
**Boneless Denver Steak** ..... 10 lbs. **18.90**  
Smaller Quantities At 2.19 lb.

# Meats



Regular or Polish  
**Eckrich Smoked Sausage** ..... lb. **1.99**

Eckrich-Beef  
**Smoked Sausage** ..... lb. **2.19**

All Varieties -10 oz.  
**Eckrich Smok-Y-Links** ..... **1.49**



Mr. Turkey  
**Turkey Ham Chub**  
**1.69** lb.  
Mr. Turkey • Turkey Breast  
**Chub**  
**3.59** lb.



Hormel  
**Chili or Cheese Frank 'N Stuff**  
1 lb. Pkg. **1.99**



Grade 'A' Premium  
**FAME Turkey**  
Limit 1 With Coupon  
10-20 lb. Average **.67** lb.  
Our Premium Quality FAME Turkey is Guaranteed to please you and your family!



Rath Sliced Black Hawk  
**Bacon**  
**1.69** 12 oz. Pkg.  
West Virginia  
Gourmet • Whole or Half  
**Boneless Ham**  
**2.59** lb.



Johnsonville  
All Varieties  
**Bratwurst or Sausage**  
Pound **2.29**

# Grocery



ADC, Electric Perk or Regular - 26 oz. Can  
**Maxwell House Coffee** ..... **3.99**  
Maxwell House All Grinds - 26 oz.  
**Decaf. Ground Coffee** ..... **6.99**  
Maxwell House Decaf. - 8 oz.  
**Instant Coffee** ..... **4.99**  
Maxwell House - 8 oz. Jar  
**Instant Coffee** ..... **3.99**



*Fresh! from Oven-Fresh Bakery...*  
Oven Fresh King Size - 24 oz. Loaf  
**Lumberjack Bread** ..... **.79**  
Mackinaw Milling - 20 oz. Loaf  
**Oatmeal Bread** ..... **.99**  
Oven Fresh Plain or Sugared - Dozen  
**Fried Cake Donuts** ..... **1.79**



"It's in there..."  
Regular or Chunky Variety  
**Prego Spaghetti Sauce**  
31.5-32 oz. Jar **1.59**



*Pick your favorite pasta...*  
48 oz. Package  
Elbow Macaroni or Regular or Thin  
**Prince Spaghetti** ..... **1.79**  
16 oz. Pkg.  
**Prince Lasagna** ..... **.99**  
Wide or Extra Wide - 16 oz. Bag  
**Dutch Maid Egg Noodles** ..... **.89**



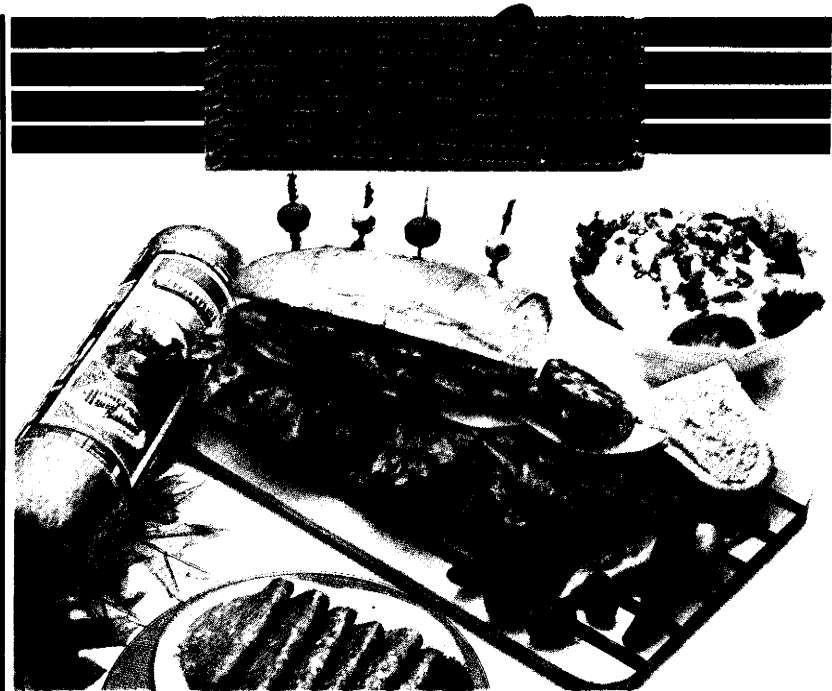
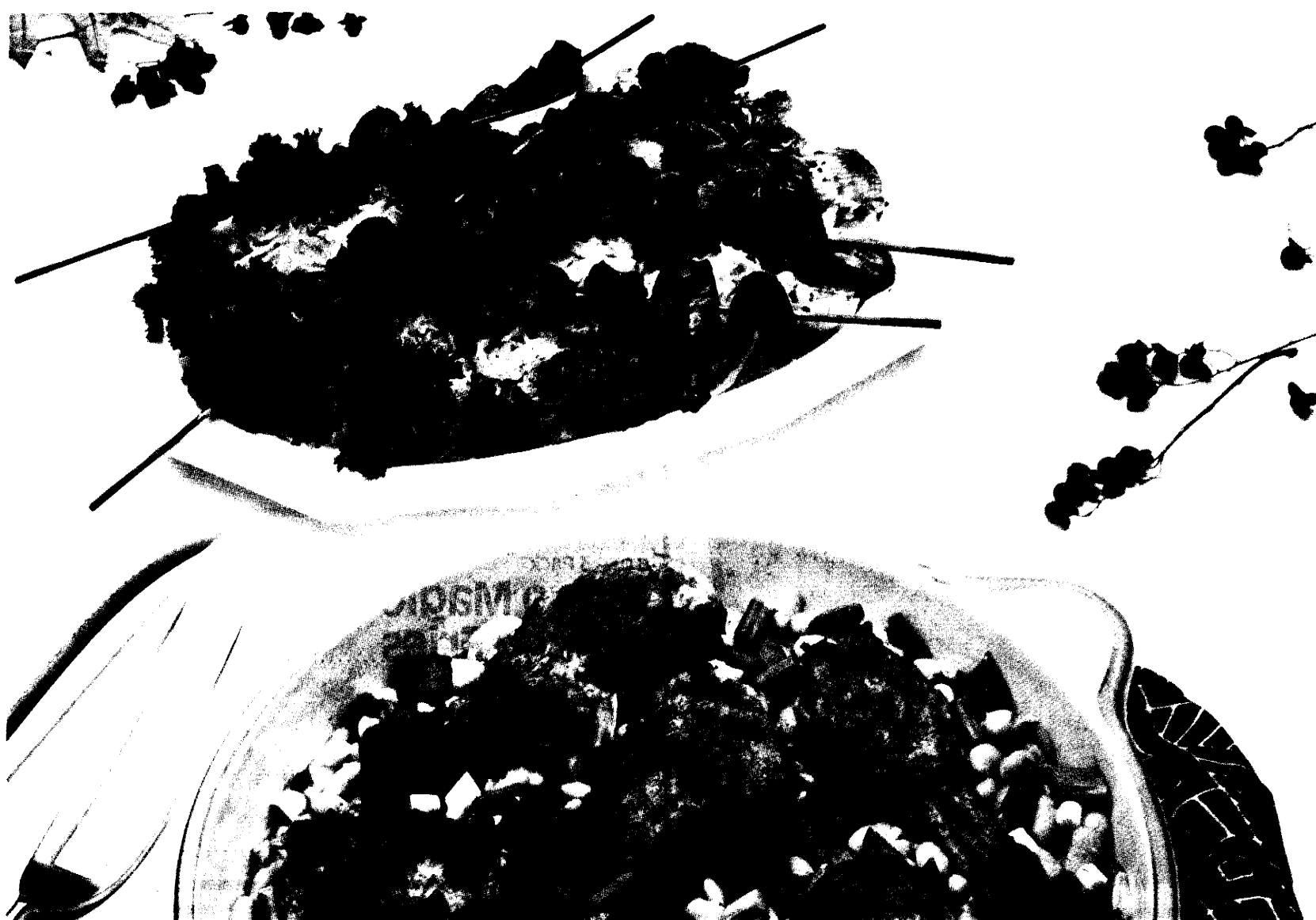

Build a super  
Sub Sandwich,  
piled high with  
sliced salami,  
cheese and  
roast beef!

Leon's Homestyle  
**Potato  
Salad**  
**1 49**  
lb.

Hormel - Sliced Your Way...  
**Homeland  
Hard Salami** ..... lb. **3 59**

Sliced To Order  
**Eckrich  
Roast Beef** ..... lb. **4 49**

Sliced To Order  
**Longhorn  
Cheese** ..... lb. **2 39**  
Available only at stores with participating Deli Depts.

HOLLY FARMS OR IGA TABLERITE:  
**Pick of The Chick** ..... lb. **.99**  
IGA TABLERITE - Beef  
**Whole Cubed Round Steak** ..... lb. **1 69**  
IGA TABLERITE - Boneless Beef  
**Rolled Rump Roast** ..... lb. **1 99**  
IGA TABLERITE:  
**Beef Cubed Steak** ..... lb. **2 29**  
IGA TABLERITE - Pork  
**Reg. or Country Style Ribs** ..... lb. **1 39**

IGA TABLERITE® - Beef  
**Round Steak**  
**1 49**  
1/4" Lean & Trim  
lb.  
IGA TABLERITE: • Fresh - With Backs Attached  
**Fryer Leg  
Quarters** ..... lb. **.39**

**FAME Sliced  
All Varieties Except Beef Bologna  
Lunch Meat**  
**1 19**  
1 lb. Pkg.

**Deer  
Hunting**

FAME Premium - Whole or Half  
**Boneless Hams**  
**1 99**  
lb.  
1 lb. Pkg. Sliced Premium  
**Fame Bacon** ..... **1 29**  
1 lb. Roll Mild or Hot  
**Fame Pork  
Sausage** ..... **.89**

**Stouffer's  
Mac & Cheese**  
**1 89**  
lb.  
Hot To Go!  
Our Own - 8 Piece Bucket  
**Bucket of Chicken**  
**4 99**

**Specials**

**Hormel Chili**  
**SPAM**  
**Dinty Moore  
Beef Stew**  
**NOT-SO  
SLOPPY JOE**

Farmer Peet - All Varieties  
**Hickory Chubs**  
**2 59**  
lb.  
Chili Hot  
**Brook's Beans**  
**.79**  
22 oz.

Regular or Low Sodium  
**Fisher's  
Mixed  
Nuts**  
12 oz. Can  
**2 99**

**3 POUND  
Hormel  
Black  
Label  
BACON**  
**Hormel  
Little  
Sizzlers**  
**Hormel  
HAM PATTIES**

THERE'S A NAME FOR FOOD THIS GOOD - HORMEL.  
Reg. or Less Salt - 12 oz. Can  
**Spam  
Luncheon Meat** ..... **1 58**  
Dinty Moore - 24 oz. Can  
**Beef Stew** ..... **1 58**  
Not So Sloppy - 14.5 oz. Jar  
**Sloppy Joe Sauce** ..... **.99**  
Hormel - Reg. or Hot - 15 oz. Can  
**Chili With Beans** ..... **.89**

Plain or  
Peanut  
**M & M  
Candies**  
1 lb. Pkg.  
**2 29**

THERE'S A NAME FOR FOOD THIS GOOD - HORMEL.  
Black Label - 3 lb. Pkg.  
**Hormel  
Sliced Bacon** ..... **5 99**  
• 48 oz. Pkg. • Family Pack Pork Sausage  
**Hormel  
Little Sizzlers** ..... **4 79**  
Hormel • 12 oz. Can  
**Canned Ham Patties** ..... **1 59**

# Frozen Foods



Turkey Dijon, Veal Lasagna, Salisbury Steak, Stuffed Cabbage With Meat Sauce or Chicken Vegetable With Vermicelli - 9.25-12.75 oz. Pkg.

**Lean Cuisine Stouffer's Entrees** ..... **1.99**

Lean Cuisine Chicken & Vegetables, Chicken A L'Orange or Glazed Chicken & Rice - 8-8.5 oz. Pkg.

**Stouffer's Entrees** ..... **2.59**

Potato Au Gratin, Macaroni & Cheese, Spinach Souffle, Escallop Apples or Noodle Romanoff - 11.5-12 oz. Pkg.

**Stouffer's Side Entrees** ..... **1.19**



Apple, Dutch Apple, Mince or Pumpkin 40 oz. Package

**Chef Pierre Pies** ..... **2.59**

Family Size - 11.25-13 oz. Pkg.

**Sara Lee Coffee Cake** ..... **2.39**

Individual - 8-9 oz. Pkg.

**Sara Lee Coffee Cake** ..... **2.19**



9 oz. - 3 Pack

**Micro Magic French Fries** ..... **.99**

4-4.75 oz. Pkg. - All Varieties

**Micro Magic Sandwiches** ..... **1.19**

All Flavors - 11.5 oz. / 2 Pack

**Micro Magic Shakes** ..... **1.49**



Frozen **Treesweet Awake Breakfast Drink** 12 oz. Can ..... **.69**



White or Wheat Frozen **Aldon's Bread Dough** 4-5/1 lb. ..... **1.49**

**Aldon's Cinnamon Sweet Rolls** 27 oz. Pkg. ..... **1.29**



**Pet-Ritz Deep Dish Pie Crust Shells** in Deep 9-inch pie pans ready to fill and bake!

Kraft LaCreme Whipped Topping or Pet Ritz - Deep Dish - 2 Pk. **Pie Shells** 12 oz. Pkg. ..... **1.19**



Your Choice... All Varieties

**Hot Pockets** 10 oz. Pkg. ..... **1.99**



Ore Ida Potatoes O'Brien or Shredded or Southern Style

**Hash Browns** 20-32 oz. ..... **1.19**

**Golden Fries or Ore Ida Crinkles** 2 lb. Bag ..... **1.39**

# Grocery

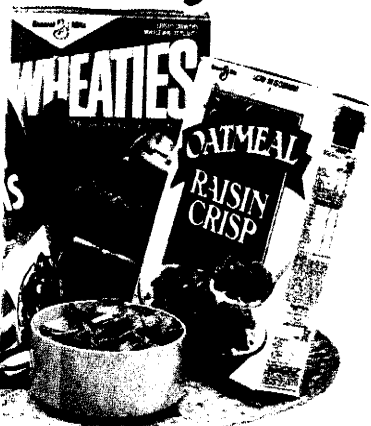

Big 'G' Oatmeal **Raisin Crisp** 15 oz. Pkg. ..... **1.99**

Big 'G' **Wheaties** 12 oz. ..... **1.59**



Orville Redenbacher All Flavors Microwave **Popcorn** 10.5-12 oz. Pkg. ..... **1.99**

Reg., Light or Mini-Marshmallows **Swiss Miss Cocoa** 12-1 oz. ..... **1.39**



Realemon **Lemon Juice** 32 oz. ..... **1.69**

Mrs. Grass **Onion Soup Mix** 1.5 oz. ..... **.39**



Del Monte - Reg. or No Salt - 16-17 oz. Cans Whole Kernel or Cream Style

**Corn or Green Beans** Cut or French Cut ..... **2/1.00**

Regular or Light - 16-17 oz. Cans Cocktail • Mixed • Peaches • Pears

**Del Monte Fruits** ..... **.79**

All Varieties Stewed - 14.5 oz. Can

**Del Monte Tomatoes** ..... **.68**

# Home



Soft tissue... Sparkling savings!

White or Prints - 4 Roll Pkg.

**Angel Soft Bath Tissue** ..... **.99**

White or Designer - 1 Roll Pkg.

**Sparkle Paper Towels** ..... **.69**



Cut Rite - 75 Ft. **Wax Paper or Reynolds's Wrap** 12 Inch - 25 Ft. Roll ..... **.69**



# Dairy Values



Your Choice  
**Swanson Entrees**  
**1.19**

- Chicken Nibble
- Fried Chicken
- Fish & Chip
- Turkey
- Saltisbury Steak
- Swedish Meatball
- Home Style Mac & Cheese
- Home Style Chicken-N-Noodle
- Home Style Tuna Noodle Casserole
- Home Style Cheese Ravioli

5.25-10 oz. Pkg.

All Varieties - 9-10 oz. Pkg.

**Pepperidge Farms Croissant Pizzas**

**2.39**



All Flavors Except With Nuts  
**Ice Cream**

1/2 Gallon Round Ctn.  
**2.19**



Betty Crocker  
**Brownie Sundae**

6 Ct.  
**2.49**  
Yoplait Soft Frozen  
**Yogurt or Goldrush Bars**  
**1.99**

6 Ct.

## Values



Assorted - 40 Ct. Pkg.

**Tampax Tampons**

**3.89**

Fashion Color - Black, Creamy Ivory or Misty Grey

**No Nonsense Knee Highs**

**.99**

Reg. or Unscented - 6 oz. Btl.

**Curel Moisturizing Lotion**

**2.49**



.35 Off Label  
**Downy Softener Sheets**  
36 Ct. Box

**2.29**



Kraft - 12 oz. Pkg.

Mozzarella, Mild or Sharp Cheddar

**Shredded Cheese**

**1.99**

Kraft - 2 lb. Tub

**Parkay Spread**

**1.29**

Pillsbury Fudge - 14 oz. Pkg.

**Microwave Brownies**

**1.69**



French Onion or Bacon & Onion  
**Dean's Chip Dip**

16 oz. Ctn.

**.99**

Vanilla, Chocolate or Tapioca  
**Swiss Miss Pudding**

**1.19**

4 Pack

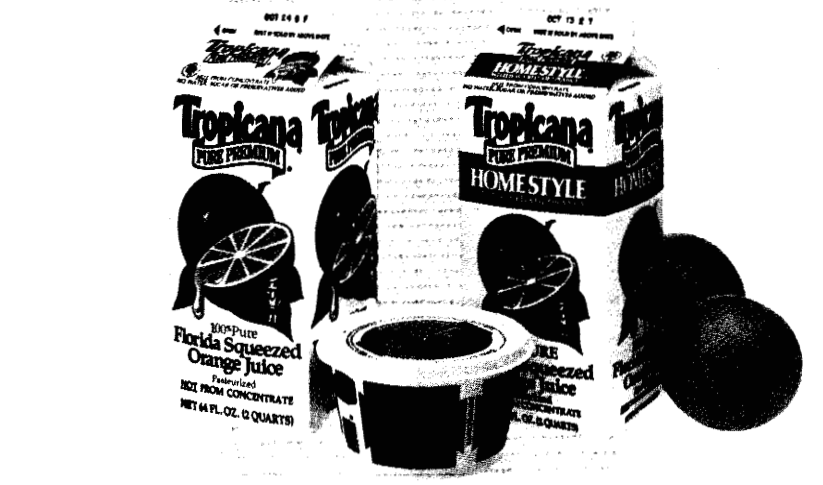

Original or Homestyle  
Your Choice...

Pure Premium - 100% Pure  
**Tropicana Orange Juice**

**2.59**

64 oz. Ctn.

Win Schuler's - 14 oz.

**Bar Scheeze**

**2.19**



Borden's  
**American Cheese Singles**  
12 oz. Pkg.

**1.39**



All Flavors  
**Low Fat Sweet 'N Low Yogurt**  
6 oz. Cups

**3.100**



22 oz. Btl. - Pre-Priced At 1.19

**Dove Dish Liquid**

**.79**

64 oz. Jug - Pre-Priced At 2.79

**All Liquid Detergent**

**2.59**

50 oz. Box - Pre-Priced At 1.79

**All Auto Dish Powder**

**1.59**

38 oz. Pkg. - Pre-Priced At 1.49

**Rinso Detergent**

**1.29**



110-24 or 135-24 - 100 Speed

**Fuji Color Film**

**2.79**

60, 75 or 100 Watt 4 Pack

**Sylvania Light Bulbs**

**1.79**

VHS T-120

**Maxell Video Cassette**

**3.99**



FAME Triple Action - 6 oz.

**Night Time Cold Medicine**

**1.99**

12 Ct. Extend Tabs or

**Dimetapp Elixir**

**3.19**

36 ct. Reg. or Flavored Tablets

**Alka Seltzer**

**2.59**



Bowl or Drain  
**The Works Cleaner**

**1.29**

32 oz.

Tub-Shower Cleaner  
**The Works**

**1.99**

32 oz.



**IGA COUPON**

Premium • Grade 'A'  
**FAME**  
Turkeys

**.67** lb.

Limit 1 - 10-20 lb. Avg.

Limit one coupon per family. Coupon and \$7.00 purchase required, excluding tobacco, alcoholic beverages, or other coupon items. Coupon expires Sat., Nov. 12, 1988.

NR 157-4

**IGA COUPON**

Great tasting  
**Del Monte**  
Catsup

**.99**

Limit 1 - 32 oz. Btl.

Limit one coupon per family. Coupon and \$7.00 purchase required, excluding tobacco, alcoholic beverages, or other coupon items. Coupon expires Sat., Nov. 12, 1988.

NR 156-5

**IGA COUPON**

Del Monte - All Flavors  
**Pudding**  
Cups

**.99**

Limit 2 - 4 Packs

Limit one coupon per family. Coupon and \$7.00 purchase required, excluding tobacco, alcoholic beverages, or other coupon items. Coupon expires Sat., Nov. 12, 1988.

NR 155-6

**IGA COUPON**

Random Weight - Amish Swiss,  
Pinconning or Frankenmuth  
**FAME** Chunk  
Cheeses

**.30** PER LB.

Limit 3 Packages

Limit one coupon per family. Coupon and \$7.00 purchase required, excluding tobacco, alcoholic beverages, or other coupon items. Coupon expires Sat., Nov. 12, 1988.

NR 154-7

**IGA COUPON**

CHUNK OF HI-PRO  
**Hy-Ration**  
Dog Food

**1.00** PER LB.

Limit 2 - 25 lb. Bags

Limit one coupon per family. Coupon and \$7.00 purchase required, excluding tobacco, alcoholic beverages, or other coupon items. Coupon expires Sat., Nov. 12, 1988.

NR 153-8

**IGA COUPON**

Original or Sunrise  
.45 Off Label  
**Downy**  
Softener

**1.99**

Limit 1 - 64 oz. Jug

Limit one coupon per family. Coupon and \$7.00 purchase required, excluding tobacco, alcoholic beverages, or other coupon items. Coupon expires Sat., Nov. 12, 1988.

NR 152-9

**IGA COUPON**

Reg. or Super Trim  
Convenience Pack - All Sizes  
**Huggies**  
Diapers

**9.99**

Limit 1 - 28-66 Ct. Pkg.

Limit one coupon per family. Coupon and \$7.00 purchase required, excluding tobacco, alcoholic beverages, or other coupon items. Coupon expires Sat., Nov. 12, 1988.

NR 151-10

**IGA COUPON**

All scents  
**Ban Solid**  
Deodorant

**2.19**

Limit 2 - 2 oz. Pkg.

Limit one coupon per family. Coupon and \$7.00 purchase required, excluding tobacco, alcoholic beverages, or other coupon items. Coupon expires Sat., Nov. 12, 1988.

NR 150-11



**U.S. No. 1 Idaho Baking Potatoes**

Fall Baking Special

**1.79** 10 lb. Bag

Julcy Sweet - 4 lb. Bag	<b>1.99</b>
Navel Oranges	
Tender Fresh - 18 Ct. Size	<b>.89</b>
Broccoli	Bunch
Campbell's - 8 oz. Pkg.	<b>.99</b>
Farm Fresh Mushrooms	
Washington Red or Golden	<b>.79</b>
Delicious Apples	lb.
Crunchy Crisp - 2 lb. Pkg.	<b>.79</b>
Sweet Carrots	
Medlum Yellow - 3 lb. Bag	<b>.99</b>
Cooking Onions	
Julcy Sweet	<b>.69</b>
D'Anjou Pears	lb.

**In-Store Bakery**

Available only at stores with participating In-Store Bakeries.

Plain or With Seeds	Plain Topped - 9 oz. Foll Pan	<b>1.09</b>
<b>French Bread</b>	Angel Food Cake	
<b>2/1.38</b> 16 oz.	Chocolate Iced and Lemon Filled	<b>6/1.29</b>
	Long John Rolls	
	Great For Breakfast - 16 oz. Loaf	<b>.99</b>
	English Toasting Bread	
	Great With Ice Cream - 8 Inch / 24 oz.	<b>2.49</b>
	Homestyle Peach Pie	

**Double Mfgs. coupons this week!**  
Up to 50¢ face value.

Our cashiers will double your manufacturer's "cents off" coupons, depending on your total purchases.

We Will Now Redeem One Coupon With Each 5.00 Or More In Purchases, Up To 10 Coupons With 50.00 Or More In Purchases - Details In Store.



CROFT CLARA  
LUMBER  
**TRUST  
WORTHY**  
HOME  
CENTERS

# FALL PROBLEM SOLVER SALE

**SALE ENDS SOON!** Dates Posted in Store.

**AMES**

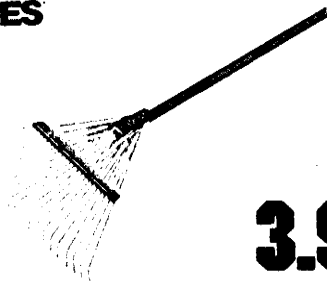

**3.99**

**22" STEEL LAWN/LEAF RAKE.** 22 Tempered spring steel tines with coiled spring brace. 48" handle.  
19-363 233478 1-A



**89.99**

**16 GALLON HIGH PERFORMANCE WET/DRY VAC WITH PORTABLE BLOWER.** Two powerful cleaning machines in one! Wet/Dry vac for heavy duty vacuuming ...1.5 H.P. portable blower for cleaning litter and debris. Includes Accessories.

**SPECIAL BONUS VALUE!** This model includes DUAL 1 1/4" & 2 1/2" CLEANING TOOLS 1-C

**SKIL. Twist**

REGULAR



**15.99**

**CORDLESS SCREWDRIVER.** Your manual screwdriver just became obsolete. 1/4" hex collet 2105, 178327 1-D

EXTRA STRENGTH



**29.99**

**CORDLESS SCREWDRIVER.** 1/4" hex collet. Auto-lock feature for use as manual screwdriver. Drives and removes a wide range of screws. Charging stand stores 10 bits, has recharging LED. Bit storage in handle of tool. 2210, 290627 1-E

**Easy  
Bagger**

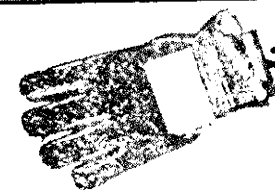

**4.79**

**TRASH BAGS.** Sturdy, reusable plastic liner that frees both hands. Won't rust. Rolls up, easy storage, prevents puncture when filling. 303131 1-F

**9.99**

**FREE GLOVE OFFER!** Warmth without bulk! Buy a pair of Wells Lamont Thinsulate lined split leather gloves, and get a pair of chore gloves FREE! Made by 3M, Thinsulate retains about twice as much heat as other garment insulations of equal thickness. W081 1-G

DISCOVER

MasterCard

VISA

THESE CREDIT CARDS WELCOME AT PARTICIPATING STORES.

**WE'RE THE ORIGINAL SAVERS**

**8' X 10' POLYUF TARP.** Rugged woven polyethylene fabric laminated with polyethylene film. Grommeted every 3 ft.

142042, 200810  
2-A  
142059, 701012  
2-B

**4.99**

**6.88**



**10 X 25 PLASTIC COVERALL.** CANARY HIDE! STAIN RESISTANT! EXTRA HEAVY! BUILT TO LAST! HUNDREDS OF USES!

281626, 281634  
2-C

**4.99**



**62" X 210" INTERIOR WINDOW INSULATION KIT.** Increases R-Value by 90%, shrinks drum tight and wrinkle free with heat from a hair dryer.

065771  
2-D

**11.99**

**62" X 210" EXTERIOR WINDOW INSULATION KIT.** Increases R-Value by 86%. No need for nails, wood strips or plastic frames.

2171

**4.99**

Hundreds of uses. Clear or black.

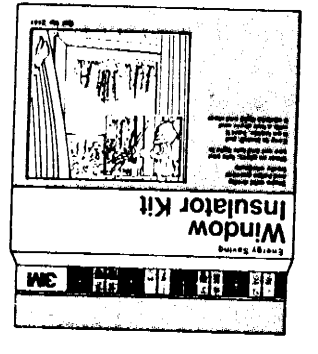
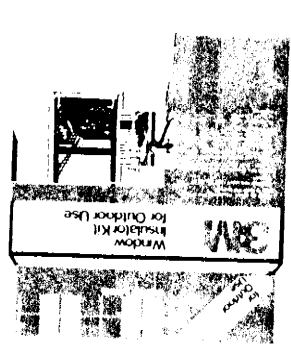
**Window Insulator Kit**

**Window Insulator Kit for Outdoor Use**

**YOUR CHOICE**

**STORM DOOR KIT.** Easy to install, conserves energy. Contains 36" X 84" plastic sheet.

061309  
2-E

**79¢**

**SAVES FUEL**



**9' GARAGE DOOR SEAL.** Tough, specially compounded extruded rubber. Resists temperature extremes. Includes nails.

015297, 910  
2-F

**3.99**



**36 1/2" ALUMINUM THRESH-OLD.** Seals drafts at bottom of doors. Vinyl bulb insert contours to fit doors.

677906, 200A  
2-G

**4.99**



**5/8" X 17" STORM QUEEN FELT.** Helps stop drafts and energy loss. Made of 3/16" thick, extra quality felt.

061556  
2-H

**59¢**



**VINYL FOAM TAPE.** Airtight self-adhesive vinyl foam is moisture resistant, easy to apply, won't scratch surfaces.

3/16" X 3/8" X 17'  
202, 061069

**79¢**

**2 ROLLS LIMIT**

**CLIP & SAVE**

**VALUABLE COUPON**

**TEST YOUR COUPON**

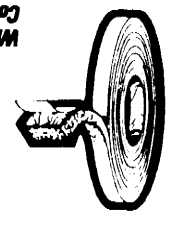

**12 Oz. FOAM INSULATION.** Insulating sealant stops drafts and pests. Fills, seals and insulates indoors and outdoors.

000380  
2-I

**3.99**

**GREAT STUFF**

**REBATE BUY NOW!**



**DOOR BOTTOM WEATHER-STRIP.** Attaches at bottom of door for draft-free seal at sill or threshold. Easy long-lasting installation. Nails or screws furnished. AS4P, 061952  
2-K

**1.88**

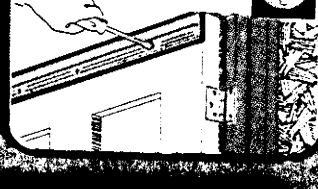



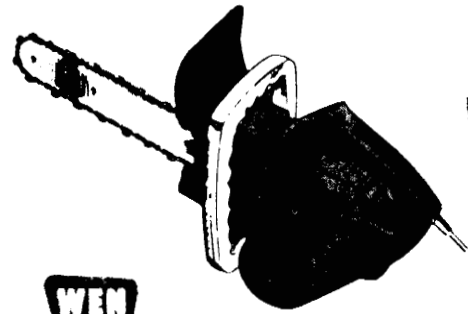

WEN

**57.99** YOUR COST AFTER \$5.00 REBATE **52.99**

**14" ELECTRIC CHAIN SAW.** Heavy duty 2 HP rating, 12 amps, 120V. Features textured non-slip front and rear handles, low profile anti kick back chain, safety pre-travel switch, adjustable clutch, and oil level indicator. 017343, 5014 3 A

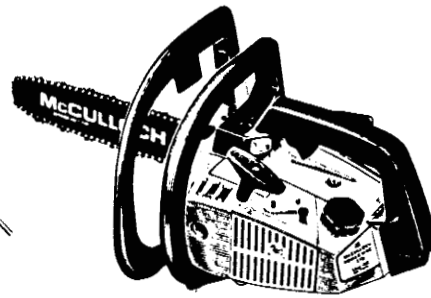

McCULLOCH

**179.99**

**POWER MAC™ 16" CHAIN SAW.** 2.1 cu. in. engine, laminated sprocket tip bar, anti-vibration system & solid state electronic ignition. Wrap around hand guard, safety trigger, & muffler shield. PM310C-16 076679 3-B

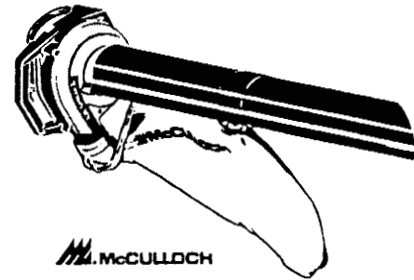

McCULLOCH

**119.99**

**GASOLINE POWER BLOWER/VACUUM with KIT.** Super Air Stream IV. 21.2cc gas engine, solid state ignition, large volume U.S.D.A. muffler, 3-position throttle lock, heavy-duty molded felt air filter. Vacuum includes: 2 high-impact vacuum tubes, built-in mulcher, 1.75 bushel vacuum bag with shoulder strap. 246272, MAC-IV 3-C

## LATE FALL PROBLEM SOLVER ITEMS

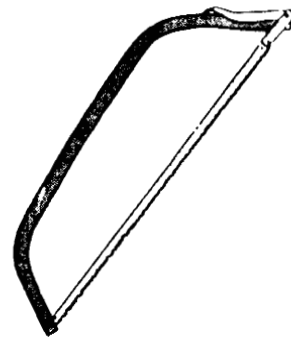

**Great Neck 4.99**

**21" BOW SAW.** Sharp steel blade. Light weight tubular steel frame with lever action blade tightener and release. BB21 365650 3-D

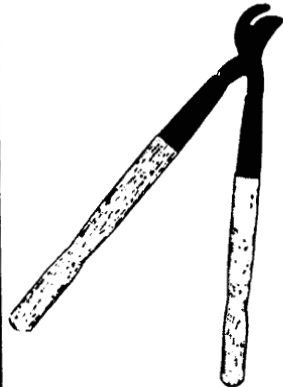

AMES **7.88**

**"HOMEOWNER" LOPPER.** TFE finish, contoured ash handles. 21 1/2" long. 233692, 23 028 3-E

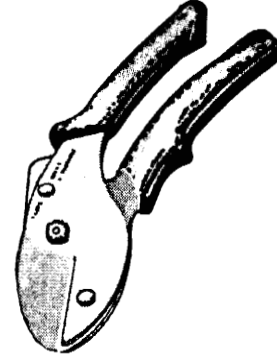

AMES **3.99**

**7" ANVIL STYLE PRUNER.** TFE blade finish. Comfortable vinyl grips. 233676, 23-052 3-F

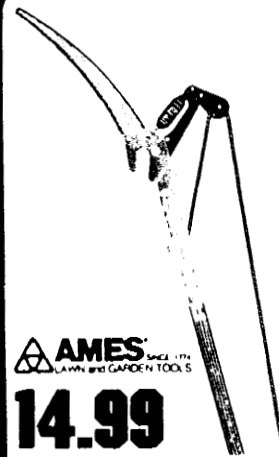

AMES **14.99**

**12" PRUNING SAW.** TFE no-rust finish cutting blade. Wood handle and 8' rope with wood pull grip. 233650, 23-264 3-G



McCULLOCH

**4.99**

**BAR and CHAIN OIL.** Extends bar, chain and sprocket life by reducing friction. 1 Gal. 282582, 094818 3-H



**8.99**

**6 Lb. WOODSPLITTING MAUL.** High carbon, forged steel head with sturdy 36" hardwood handle. 012971 3-I

WILLIAMS **COUPON**

**VALUABLE COUPON**

LIMIT 2 PAIR



**99¢**

WILLIAMS **With Coupon**  
**BROWN COTTON JERSEY GLOVES.** Clute cut pattern. Snug fitting brown knit wrist. Large. 088138 3-J

Coupon Good Through Sale Only

**CLIP & SAVE**

**BLACK & DECKER**



**34.99**

**3/8" CORDLESS 2-SPEED REVERSIBLE DRILL.** Operates at 170 rpm & 400 rpm forward and reverse. Double gear reduction for driving screws. Built-in chuck key holder. Includes 3-hour charger and chuck key. Full 2-year home use warranty. 118182 9020 4-A

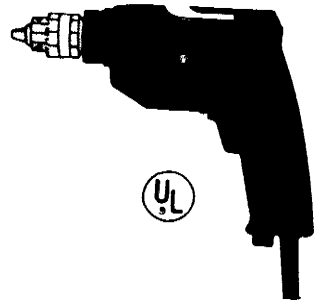

**49.99**

**MODEL 1166 3/8" HOLDGUN® VSR DRILL.** Accu-Bore™ level for accurate hole drilling. Powerful 4.0 amp, 350 watt motor. Excellent grip and balance for drilling control and user comfort. Variable speed reversing; 0-2500 RPM. 318741 1166 4-B



**13.99**

**HEAVY DUTY STAPLE GUN.** Uses six staple sizes, 1/4" to 9/16", and Ceitile® for ceiling tile. 008409 T-50 4-C

**WE'RE THE PROBLEM SOLVERS**



**"Pony"**

**PIPE CLAMP FIXTURES.** Exclusive "extended" clutch-disc design. Adjusts quickly, secure hold, easy release. Pipe not included.

1/2"	52	<b>6.99</b>
000356	4-D	
3/4"	50	<b>7.99</b>
000307	4-E	

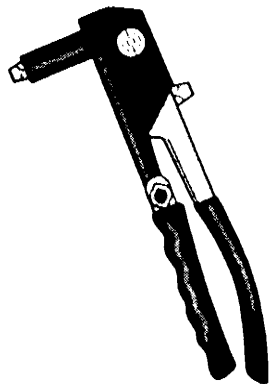

**EMHART™ Bostik 11.99**

**HEAVY DUTY POP® RIVET-TOOL.** Fastens metal, wood, plastic, leather, etc. Hundreds of uses around the house. 442558 K111 4-F

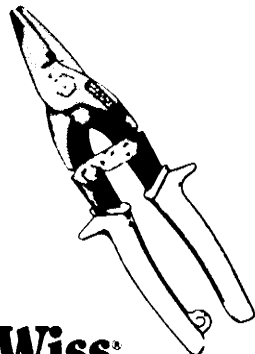

**Wiss® 6.99**

**MULTI-PURPOSE CUTTER.** Cuts screening, light gauge sheet metal, tiles, carpeting, etc. Serrated jaws, vinyl grips. 459958 MPC3 4-G



**4.99**

**EKLIND HEX KEY WRENCH.** Fold-up set. Keys of chrome nickel alloy steel, hardened and tempered. All fold into convenient handle. 5 keys—<sup>3</sup>/<sub>16</sub>-<sup>3</sup>/<sub>8</sub> in. 5 1/4 in. handle. 252072 51 4-H

**VALUABLE COUPON**

**88¢**

LIMIT 3 EACH With Coupon

**FULLER**

**BUCKET OF SCREWDRIVERS.** Unbreakable plastic handles, durable plated blades. Choose from 4 popular sizes. 4-I

Coupon Good Through Sale Only

**CLIP & SAVE**

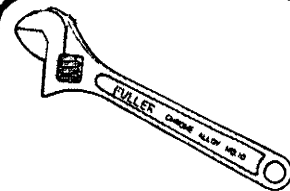

**FULLER 5.99**

**8" ADJUSTABLE WRENCH.** Drop forged chrome alloy steel, fully ground and chrome plated. 132704 8 4-J

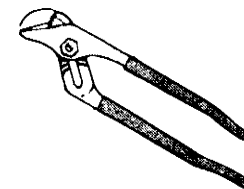

**FULLER 5.99**

**10" GROOVE LOCK PLIERS.** Drop forged steel. Fully polished rustproof finish. Vinyl grip handle. 124008 113 4-K



BLACK & DECKER

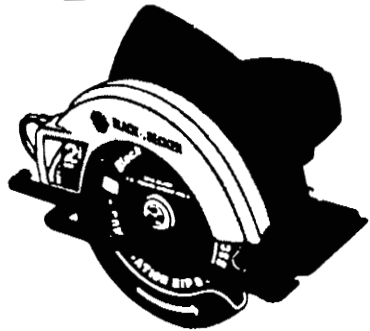

44.99

7 1/2" CIRCULAR SAW. Power for the big jobs and consistent use. Metal upper and lower blade guards. Two handles for steady control. Sturdy steel wraparound shoe for added support. Cutting depth: 2 1/16 in. at 90°, 1 7/8 in. at 45°, 120V AC, 10 amps, 6 ft. cord, 5300 RPM. 104182 7391 5-A



179.99

10" ROTARY MITRE SAW. Free 60-tooth Piranha™ carbide tipped blade. Powerful 2 HP motor for efficient operation. Accurate cast and machined mitre scale for easy reading. Compact and lightweight lock holds motor down for easy carrying. Adjustable dust collector chute. Full 1-year warranty. 1703 5-B



BLACK & DECKER

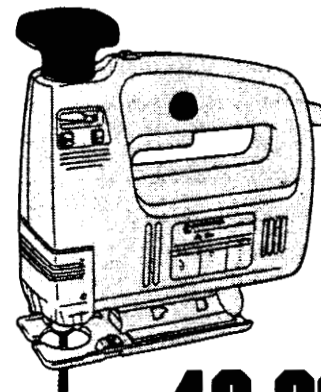

BLACK & DECKER

49.99

7588 VARIABLE SPEED ELECTRONIC AUTO SCROLLING JIG SAW. Option of manual, auto-scrolling or straight cutting for ease of cutting intricate designs. Electronic speed control maintains constant speed under load. Speed can be preset or varied during cutting. 3.5 amps, 800-3200 spm. Includes: chip deflector, 2 blades, built-in blade storage. 5-C

# FALL WORKSHOP SALE!

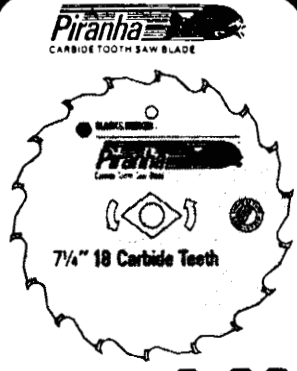

BLACK & DECKER 6.99

7-1/4" #73-717 18 CARBIDE TEETH BLADE. Stays sharp up to 50 times longer than steel saw blades. For fast, semi-smooth rips, crosscuts and miters. Ideal framing blade. 060210 5-D



17.99

7 PC. TORCH KIT. With pencil flame burner, blow torch burner head, flame spreader, spark lighter, flints & propane cylinder. 436105 94231 5-E

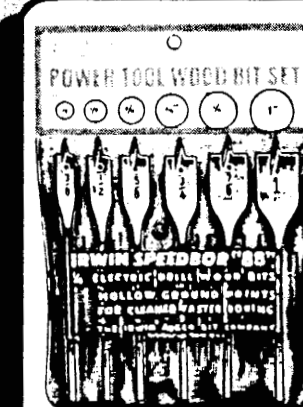

7.99

6 PC. SPEEDBOR BIT SET. High quality tool steel bits, one each in sizes 3/8", 1/2", 5/8", 3/4" 7/8" and 1". 88098 183921 5-F

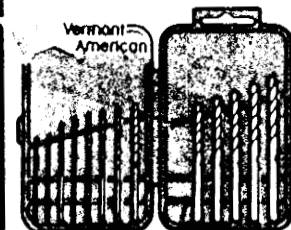

8.99

13 PC. DRILL BIT SET. Precision-crafted for drilling metal, wood and plastic. Sizes: 1/16"-1/4". Includes plastic case. 552711 10245 5-G

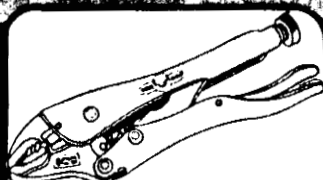

Sale Price **6.99** Your Cost After Rebate  
Less Mail In Rebate... **1.50** **5.49**

10" LOCKING PLIERS With WIRE CUTTER. Heavy-duty for maximum strength and capacity. 301804 10WR 5-H



19.97

476 REMINGTON POWER HAMMER. A quality fastening tool designed for the do-it-yourselfer. Uses power fasteners and power loads to quickly fasten wood and other materials into concrete, steel and masonry. Ideal for finishing basements, putting up decking and many other home projects. UL listed. 118083 78708 5-I

**VALUABLE COUPON**

**STANLEY**

**With Coupon 1.99**

2-WAY UTILITY KNIFE. Two positions. Two extra blades packed in 5 1/2" handle. 390559 10-299SP 5-J

Coupon Good Through Sale Only.

**CLIP & SAVE**

# FREE

## HOMETIME VIDEO

# WIN

AS \$218.00  
HOME IMPROVEMENT  
VIDEO LIBRARY

Buy \$8 worth of Stanley tools\* and receive your choice of an instructional, do-it-yourself video from Hometime, producers of the popular PBS TV series. Then, see if you measure up to the Stanley Tools Home Improvement Challenge — you could win your ultimate home improvement, 1 of 10 Chevy trucks, \$1,000 worth of Stanley tools and 1 of 100 complete Hometime video libraries.

See in-store display for details.

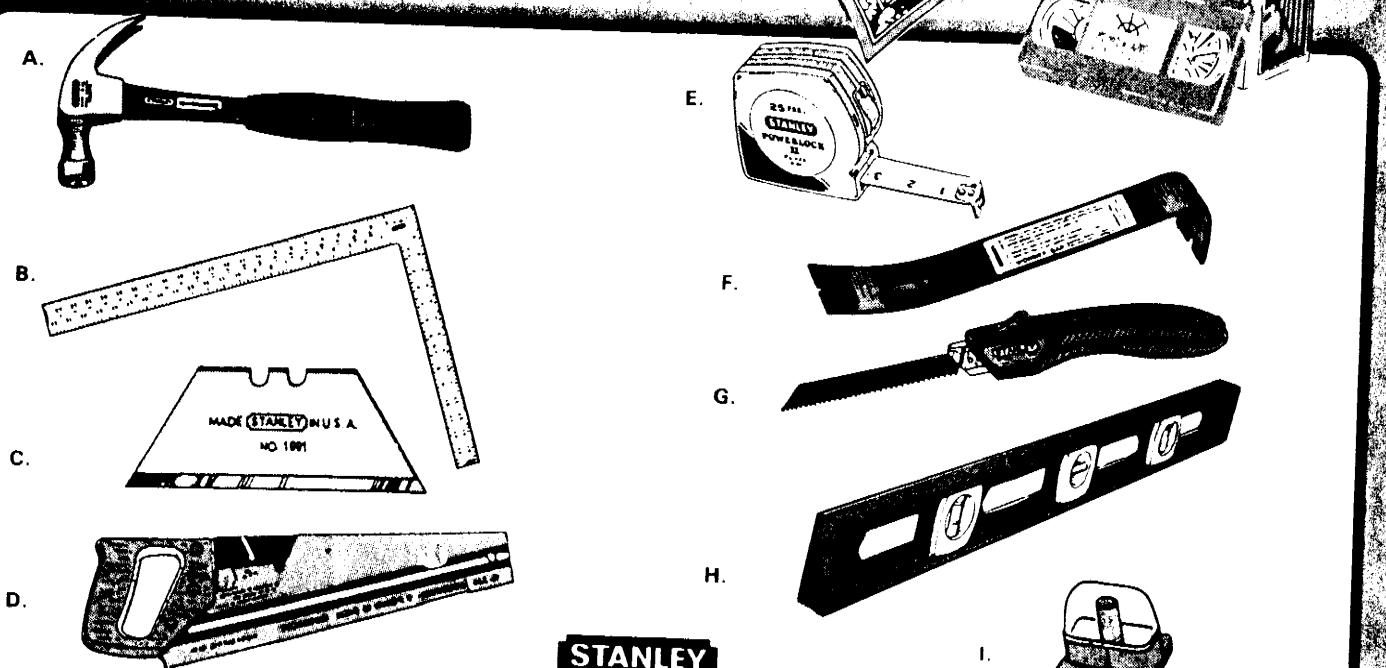
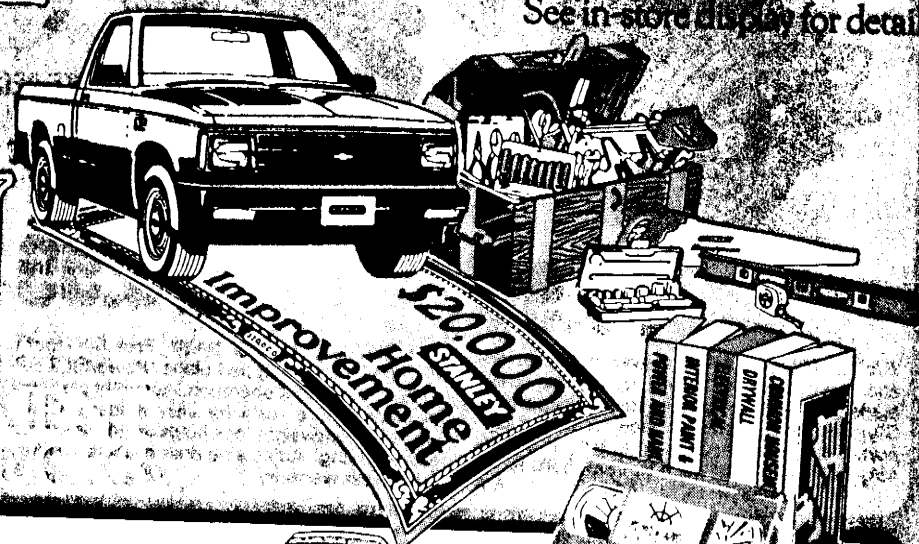

**STANLEY**

**16 Oz. FIBERGLASS HANDLE HAMMERS.** Forged steel, fully hardened and tempered heads for extra strength and performance.

**A** 16 Oz. CLAW HAMMER. 396663, 51-110SP  
16 Oz. RIP HAMMER. 396689, 51-518SP 6-B

Your Choice  
**10.99**

**B** 24" X 16" HANDYMAN® CARPENTER SQUARE. 1/8" graduations on face and back with reverse reading scale. Lacquered finish, embossed graduations and figures. 396259, 45-500SP 6-C

**3.99**

**C** Pack of 5 REPLACEMENT UTILITY KNIFE BLADES. Heavy duty blades are interchangeable with most other makes of utility knives. 387001, 11-921SP

**99¢**

**D** SHORT CUT™ TOOL BOX SAW. Compact 18" length for easy storage and handling. Fits easily into 19" tool box. Super-fast cutting teeth deliver clean cuts, super fast. 242206, 15-334SP

**9.99**

**E** 25 Ft. POWERLOCK® TAPE RULE. 1" non-creeping, long lasting Mylar blade has 1/16" graduations. Side locking knob and belt clip. 33-425SP 6-F

**9.99**

**F** WONDER BAR. 12 1/2" forged steel. Ideal for prying, lifting, scraping and pulling nails. 410555, 55-515SP

**4.99**

**G** HANDYMAN® FOLDING POCKET SAW. Folds like a jackknife. Accepts standard, sabre and reciprocating saw blades. 189084, 15-333SP 6-H

**5.99**

**H** 24" WORKMASTER™ LEVEL. 360° Catseye color vials, protected with dust resistant vial covers. 092486, 42-240SP

**9.99**

**I** MAGNETIC STUD FINDER. Grooved base for precise markings. 396002, 47-400SP

**1.99**



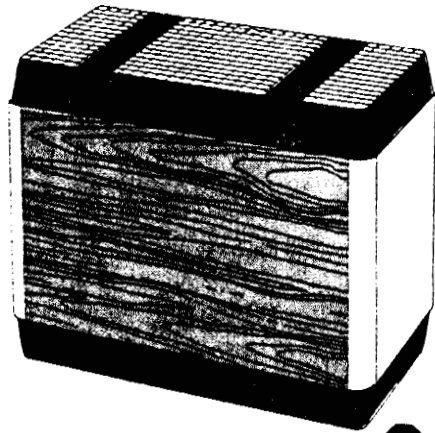

**34.99**

**BEMIS SPACE SAVER PORTABLE HUMIDIFIER.** A compact portable that gives you a maximum of clean moistened air wherever you need it—home, school or office. Great for plants, too. Features a removable power pak for easy cleaning. 1,000 sq. ft. capacity. 273698, 4006 7-A

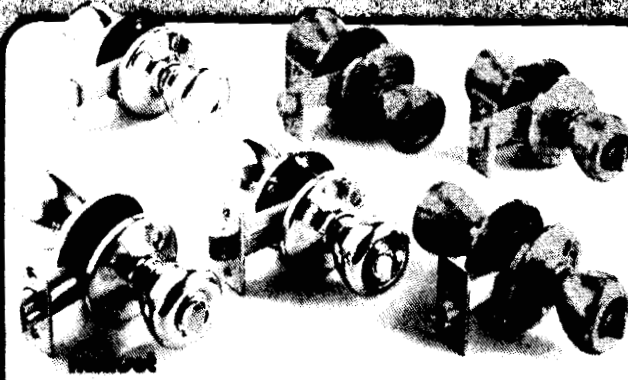

**TYLO LOCKSETS**

**BRASS FINISH PASSAGE.**

For doors that don't require locking. 200T-3 7-B

**4.99**

**ANTIQUE FINISH PASSAGE**

200T-5 7-C

**5.99**

**BRASS FINISH PRIVACY.**

For doors that require locking. 300T-3 7-D

**5.99**

**ANTIQUE FINISH PRIVACY**

300T-5 7-E

**6.99**

**BRASS FINISH ENTRY.**

Keyed for outside, turn-button inside. 400T-3 7-F

**7.99**

**ANTIQUE FINISH ENTRY**

400T-5 7-G

**8.99**

**FALL PROBLEM SOLVER SALE**

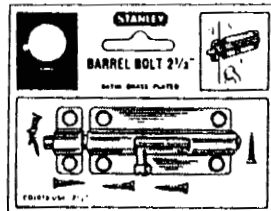

**STANLEY**

**99¢**

**2 1/2" WROUGHT STEEL DOOR BOLT.** Multi-purpose door bolt for average weight doors, etc. Satin finish. 367953 CD1078 7-H

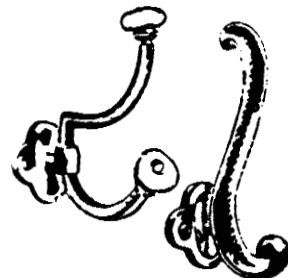

**4.99**

**COAT & HAT HOOK.** Porcelain Tips. 5 1/2" overall. 4" projection. Antique Brass finish. 061291, P79AB 7-I

**3.99**

**COAT HOOK.** 5" overall. 2 1/2" projection. Lancaster finish. 125468, P490LP 7-J

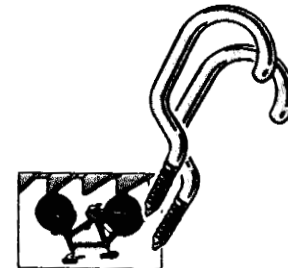

**69¢**

**UTILITY BICYCLE HOOKS.** Save space, organize storage, keeps bicycles and ladders out of the way. Package of 2. 133892 7-K

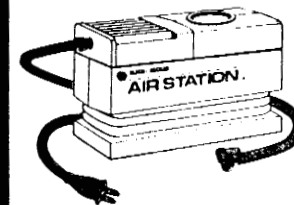

**BLACK & DECKER**

**49.99**

**AIR STATION INFLATOR/COMPRESSOR.** 120 volt, 120 psi, accurate built-in pressure gauge. 6" hose and 3 inflation nozzles. 299826, 9527 7-L



**19.99**

**SK 3/8" DRIVE 11-PC. SOCKET SET IN PLASTIC CASE.** 3/8, 7/16, 1/2, 9/16, 5/8, 11/16, 3/4" 12 pt. sockets, 5/8" spark plug socket, ratchet and 3" extension. 188565, 292117-M



**4.99**

**8' GARAGE & TOOL ORGANIZER™.** Two 4' sections. Heavy duty galvanized steel holds up to 24 tools. TH96, 203208 7-N

**VALUABLE COUPON**

**LIMIT 6**

**With Coupon 39¢**

**8" X 10" SHELF BRACKET.** Heavy gauge steel. 612929 7-O

Coupon Good Through Sale Only

**CLIP & SAVE**

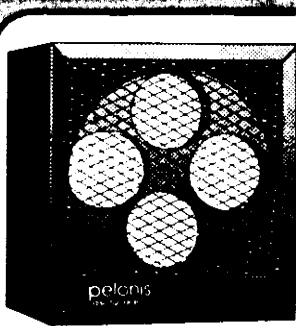

pelonis  
**129.99**

**SAFE-T-FURNACE.** Small but powerful. 5200 btu's, dual control. Heats large rooms, thermostatic comfort control, low operating costs. 245-795, 1500W 8-A

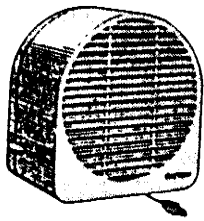

**PATT&N 16.99**  
**COMFORT CONTROL.** Cool, heat, off. 1000 watt, 3114BTU. Circuit breaker system. 8-C

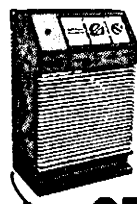

**PATT&N 37.99**  
**ELECTRIC HEATER.** Circuit breaker safety system. Electronic programmable controls and digital time display. Three heats, 500/1000/1500 watts. 8-D



**The Instant Cold Cure.**

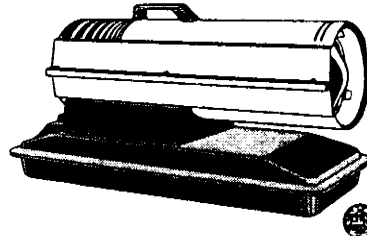

**149.99**

**35,000 BTU REDDY HEATER® PORTABLE FURNACE.** Don't let the cold stop you cold. Why freeze trying to enjoy your favorite activities in an unheated shop, garage, or other work area. Reddy Heater will keep you warm and comfortable. Operates for pennies an hour. Uses clean-burning kerosene or #1 fuel oil. Just provide ventilation, plug it in and you're in business!

S85760

R35A

8-B

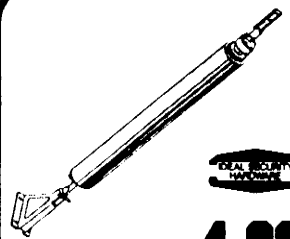

**4.99**  
**PNEUMATIC DOOR CLOSER.** Adjustable closing power. Aluminum or black finish. 175703, 175711 8-E

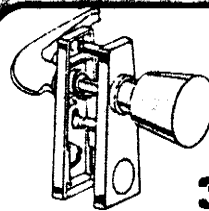

**4.99**  
**LATCH SET.** For doors 1" to 1 1/4" thick with night lock. Black or aluminum finish. 11-1533, 11-1543, 8-F



**9.99**  
**5 1/4 GAL. KEROSENE CAN.** 26 gauge steel, coated to resist rust. Enamel exterior finish. Single seam construction. Plastic pour spout with attached cap. Poly vent. 007161 CMP5K 8-G



**5.99**  
**5 1/4" SMOKE DETECTOR.** Lifesaver battery operated. All features dual ionization chambers, solid state circuitry, test button and low battery indicator that chirps every 30-40 seconds for a minimum of 7 days. Loud pulsating 85 Db horn alarm. Uses 9-volt battery. 116285, 0905 8-H

**VALUABLE COUPON**

**BEDE** **99¢**  
**AIR DEFLECTOR.** Adjusts from 8" to 14". Heavy duty magnets attach to floor or wall registers. 270215 8-I

Coupon Good Through Sale Only

**CLIP & SAVE**

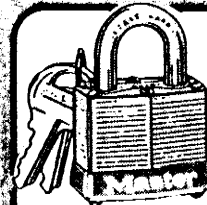

**Master 3.99**  
**1 1/2" PIN TUMBLER LOCK.** Laminated, Cadmium rust-proofed steel case. Nickel-plated shackle. Brass keys. 3-D 233452 8-J

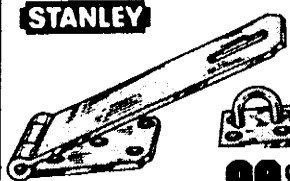

**99¢**  
**2 1/2" WROUGHT STEEL HASP.** For light cabinets, tool and tackle boxes. Fixed staple. When fastened, all screws are concealed and cannot be removed. 135855, 911 8-K



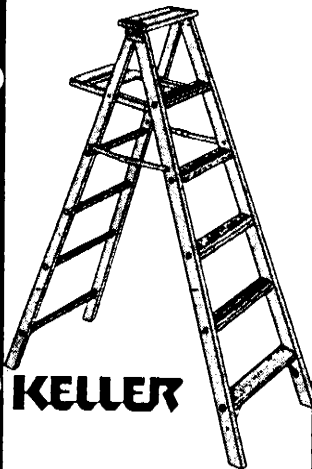

**KELLER**

**19.99**

**6 Ft. WOOD STEPLADDER.** Convenient pail shelf. 126417 9-A

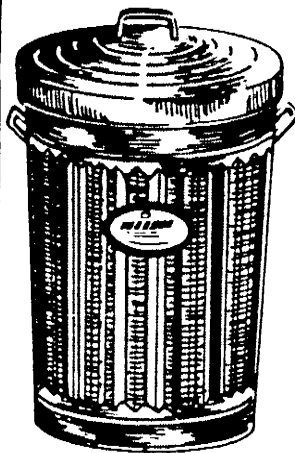

**BEHREN'S**

**9.99**

**31 GAL. LARGE GALVINIZED GARBAGE CAN.** Corrugated and swaged sides for strength. Wire reinforced rim. 1270, 046664 9-B

**OPUS**



**2.88**

**SILo FEEDER.** Includes 1 lb. of seed mix. Feeds 4 birds at once. 330241 9-C

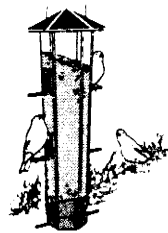

**Rubbermaid**

**YOUR CHOICE**

**4.99**

**FINCH OR SMALL BIRD FEEDERS.** Attracts a variety of small birds. Holds 2 lbs. of birdseed. Transparent, gives "At A Glance" check of birdseed level. 9-D



**5 LB. WILD BIRD SEED**

**99¢**

**5 LB. SUNFLOWER SEED**

**1.99**

9-E



**2.99**

**2" X 60 Yds. GENERAL PURPOSE DUCT TAPE.** A poly coated cloth tape. Strong and tough with good adhesive. For indoor-outdoor use. Good for sealing, wrapping and binding. Easy to apply. Silver color. 550160, 6700P 9-F



**Estwing**

**27.88**

**26" HACHET with SHEATH.** Forged one-piece solid steel construction eliminates loose heads; full polished. With exclusive nylon-vinyl deep cushion safety grip, molded on to stay on. 570457, E45A 9-G

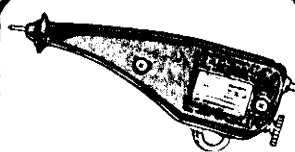

**WEN 6.99**

**ELECTRIC PENCIL ENGRAVER.** Engrave your valuables for easy identification. Super hard tungsten tip. 21-B 9-H

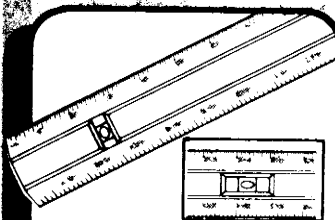

**Johnson 4.99**

**48" PLASTIC LEVEL VIAL.** Bold, easy-to-read numbers. Use as a yardstick or level. For woodworking, wallpapering, etc. 124966 9-I



**AMERICAN 99¢**

**STEEL WOOL PADS.** Choose from fine to coarse textures. Cleans, smooths and polishes. 8 pads per pack. 10-6030-37 9-J

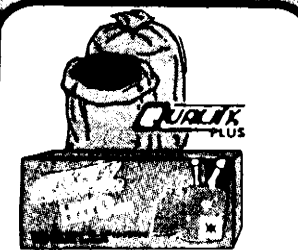

**1.88**

**TRASH BAGS.** Puncture and tear resistant. 6 bushel capacity. LD112TL10, 213827 9-K



**TUCKER**

Your Cost After Rebate

**6.99**

Sale Price **8.99**

**30 Gal. TRASH CAN.** Snap lock cover, rust and dent resistant. 0229 9-L

**TEST YOUR COUPON**

**VALUABLE COUPON**

**DURO**

**99¢**

**1 3/4 Oz. DUCO HOUSEHOLD CEMENT.** Dries fast and clear. For use on china, wood and glass. 673996, 6242P 9-M

Coupon Good Through Sale Only.

**CLIP & SAVE**



**OUR BEST**

**TRUST WORTHY**

**50 YEAR DURABILITY**

12 Oz. **ALL PURPOSE ENAMEL SPRAY PAINT.** Special rust inhibitor formula in a variety of colors. 19860-886 10-A

**1.99**

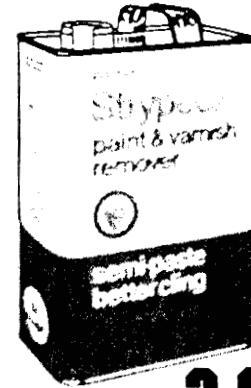

**SAVOGRAN**

**2.99**

Quart **STRYPEEZE® PAINT & VARNISH REMOVER.** Semi-paste works on Latex, oil base paints, lacquers and varnishes. 673517, 01102 10-B

Gal. **STRYPEEZE®** 673525, 01103 10-C

**9.99**



**2.37**

Gal. **MINERAL SPIRITS PAINT THINNER.** Premium petroleum based solvent. Use to thin paint or as a cleaner & degreasing agent. 020806 091348 10-D

**WE'RE THE PROBLEM SOLVERS**



**1.49**

10.5 Oz. **ACRYLIC LATEX CAULK with SILICONE.** Paint within two hours. Indoor/outdoor use. White. 18101 100552 10-E



**2.49**

'230' **SILICONE SEALANT.** Permanent adhesion & lifetime flexibility. 50 year durability. Resists mold & mildew. Paintable/water cleanup. Available in clear or white. 220889, 144253 10-F

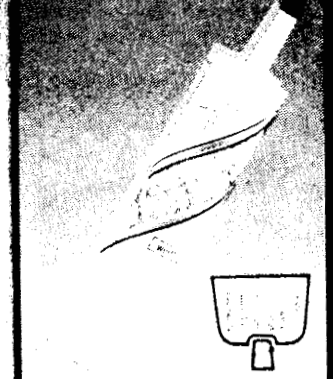

**3.89**

**DOW CORNING®** 10.3 Oz. **PERFORMANCE PLUS™ SILICONE SEALANT.** Cleans up with water, paintable. Interior/exterior. White. 08654, 314542 10-G

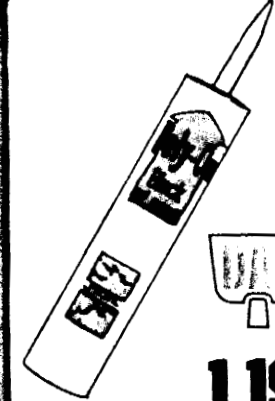

**1.19**

**RELY-ON® ROOF CEMENT.** General purpose asphalt sealer. Repairs minor roof leaks. Fills cracks around flashings, gutters, chimneys and skylights. 18210, 100685 10-H

**TRUST WORTHY COUPON**

**VALUABLE COUPON**

LIMIT 4

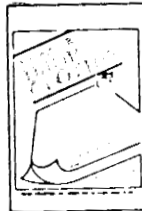

With Coupon

**99¢**

9' X 12' **PLASTIC DROP CLOTH.** 1 mil embossed plastic for greater flexibility and strength. Medium weight. 10D 10-I  
Coupon Good Through Sale Only

10

**CLIP & SAVE**



**Red Devil**

**1.39**

1/2 Pint **ONETIME® SPACKLING.** Won't crack, sag, or shrink or your money back. Requires little or no sanding. 074658, 0542 10-J



**1.79**

**CAULKING GUN.** Ratchet type caulking gun provides trouble free performance. 206896 10-K





**BEST QUALITY BRUSHES.**  
Handcrafted formulations to assure proper stiffness, flex and taper ratio. Processed filament ends provide maximum paint pickup and smooth, even paint release. Precise chisel trimmed brush tip for a sharp painting edge.

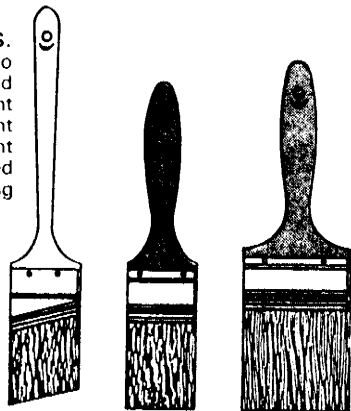

1 1/2" ANGULAR SASH BRUSH

**2.89**

591230 11-A

2" FINISHING BRUSH

**2.99**

590877 11-B

4" WALL BRUSH

**5.99**

590901 11-C

**FLEX-O-LADDER II**



12 1/2 Ft. 221119 11-D

**99.99**

**129.99**

16 1/2 Ft. 22127 11-E

**FLEX-O-LADDER II.** Folds to an ultra compact size for easy storage...even in the most compact auto. It weighs only 30 lbs. (12.5') and the 16.5 foot size weighs only 35 lbs. Meets OSHA-ANSI requirements for type II ladders.

**FALL PAINT SUPPLY SALE**

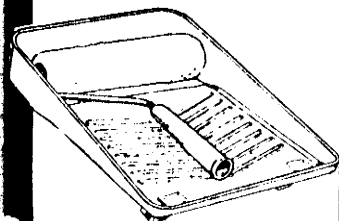

**1.99**

**ECONOMY 3-PIECE SET.** Set contains one 9 in. economy latex roller cover, one economy roller frame and one deluxe metal tray.

012120 B102 11-F

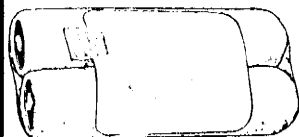

**1.00**

**ECONOMY TWIN PACK 9" ROLLER COVERS.** Features two 9 in. latex roller covers. Medium nap. For use in latex paints on smooth and semi-smooth surfaces.

TWE9126 230094 11-G



**1.37**

**ADALOX HANDY PACKS.** Assorted, 9" x 11" sheets. The best all-purpose sandpaper for wood, metal, plastic and composition. Assortment contains two each very fine and fine and one medium sheets.

243402 47765-6 11-H

**KELLER**

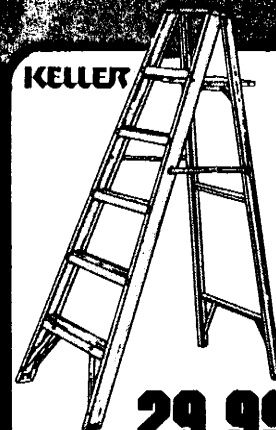

**29.99**

**ALUMINUM 5 FT. STEP-LADDER.** Auto-fold paint tray, shelf-tested to 100 lbs. Full 3" side rail and step with slip resistant surface, each step double riveted. Safety feet with slip resistant vinyl.

189340 925 11-I

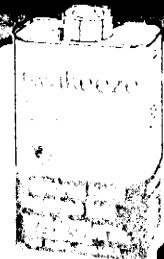

**SAVOGRAN KWIKEEZE 2.99**

**KWIKEEZE BRUSH & ROLLER CLEANER.** Cleans pure bristle, nylon and polyester brushes and rollers. Qt.

01152 673566 11-J

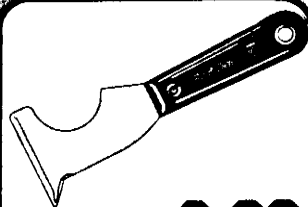

**Red Devil 2.99**

**5 IN 1 PAINT TOOL.** Has 5 different uses: scraper, putty remover, spreader, roller cleaner, and crack opener.

4251 254045 11-K

**JOINT**

**VA**

**COUPON**

LIMIT 2

**DURO**



**With Coupon 99¢**

**QUICK GEL™ SUPER GLUE.** Revolutionary thick no-run formula bonds in seconds. 2 grams. SGG-1 162115 11-L

Coupon Good Through Sale Only.

**CLIP & SAVE**

11

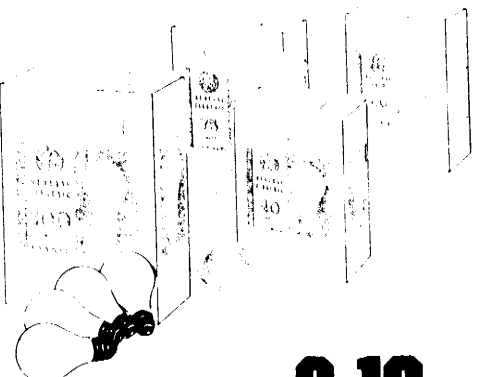

**2.19**

**4 Pack SOFT WHITE LIGHT BULB.** Soft white coating reduces glare. Your choice of 40, 60, 75 or 100 watts. 40A/W, 60A/W, 75A/W, 100A/W 12-A

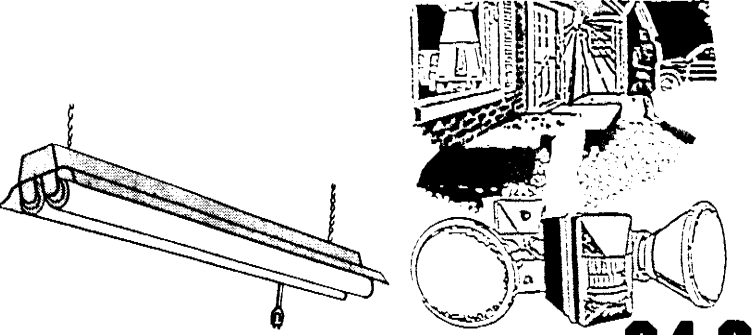

**9.99**

**48" FLUORESCENT ALL PURPOSE SHOPLIGHT.** Uses two 40 watt bulbs (not included). Ceiling chain and grounded plug. FA04OR 299578 12-B

**34.99**

**ENTRYWAY MOTION SENSOR LIGHT CONTROL.** You can have that extra security and convenience that only automated lighting can give you. The Entryway Motion Sensor Light Control automatically activates outdoor lighting when it senses approaching people and vehicles. Scares away intruders and lights your entryway when you return home. Detects motion up to 75' away in an area of over 4500 sq. ft. Fully automatic or manually operated from a wall switch. Saves energy by deactivating light control during daylight. SL5410 12-C

**WE'RE THE PROBLEM SOLVERS**

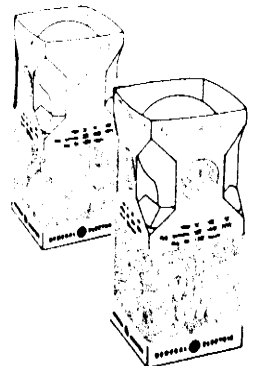

**1.69**

**3-WAY SOFT WHITE BULB.** Soft white coating reduces glare. 30, 70, 100 watts or 50, 100 and 150 watts. 30/100, 50/150 12-D



**3.88**

**CLAMP LAMP.** 8 1/2" heavy aluminum shade. Swivel clamp holds socket in any position. 6' cord. 04170, 079319 12-E



**5.99**

**DO-ALL TIMER.** Fully automatic plug in timer, 1875 watts, 15 amps. Beige case with walnut grained front inlays. UL approved. Model 12-010 110965 12-F



**29.99**

**175-WATT MERCURY VAPOR SECURITY LIGHT.** More light than three 150 watt floodlights. Automatic on at dusk, off at dawn. R175M 12-G

**VALUABLE COUPON**

**LIMIT 4**



**1.19**

*With Coupon*

**40 WATT COOL WHITE FLUORESCENT BULB.** 4' tube lasts 25 times longer than ordinary light bulbs. Use in garage and workshops. F40CWSHOP 328302 12-H

Coupon Good Through Sale Only

**12** **CLIP & SAVE**



**3.99**

**250 WATT INFRARED HEAT LAMP BULB.** Provides constant space heating where you need it. 250R40/1 12-I

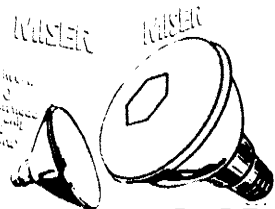

**4.49**

**MISER FLOODLIGHT.** Uses fewer watts to produce the illumination of an ordinary light. 150PAR/FL120WM.168385 12-J



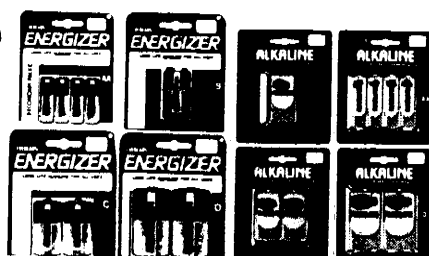

EVEREADY RAYOVAC

ALKALINE BATTERIES

**RAYOVAC® 4.99**

**WORKHORSE™ FLASHLIGHT WITH 2 "D" BATTERIES.** New krypton bulb with 70% more light. Corrosion-resistant case. Full life-time replacement warranty. WH2S 286526 13-A

4 Pack "AA" SIZE 815-4P, E91BP-4 13-B **2.49**

2 Pack "C" or "D" SIZE 813-2P, 814-2P, E93BP-2, E95BP-2 13-C **1.99**

9-VOLT A1604-1P, 522BP 13-D **1.99**

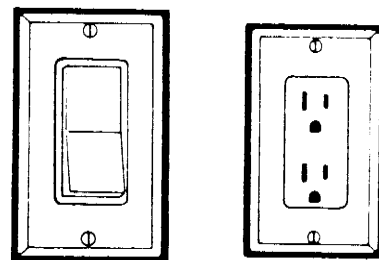

LEVITON

**DECORATIVE SWITCH & WALL PLATE.** Ivory or white. 802-5671-I, 802-5671-W 13-E **2.99**

**DECORATIVE GROUNDING OUTLET & WALL PLATE.** Ivory or white. 801-5675-I, 802-5675-W 13-F **1.99**

**ELECTRICAL SUPPLY SALE!**

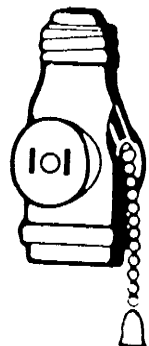

LEVITON

**1.29**

**PULLCHAIN LAMPHOLDER.** Converts single socket to a lampholder plus two outlets for standard plugs. 1406-B, 1406-I 13-G

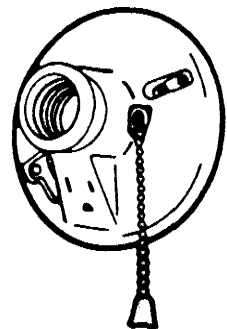

LEVITON

**2.99**

**PORCELAIN LAMPHOLDER With PULLCHAIN & GROUNDED OUTLET.** Fits 3 1/4" or 4" outlet box. With 3' pull cord and screws. 9726C 13-H



**3.88**

**CRIMP TOOL KIT.** With assorted terminals. LY8007R, 133991 13-I

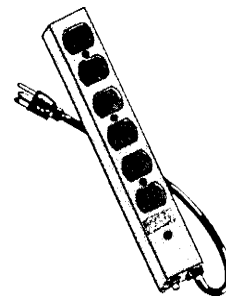

**9.99**

**OUTLET CENTER.** Grounded 3-prong receptacles. On/off switch with pilot light. 6 ft. 14/3 cord. Unique mounting system. Push-to-reset circuit breaker. 6 outlets. 156471 E06-6 13-J



© CAROL

**7.99**

**50' 16/3 DOUBLE INSULATED HEAVY DUTY OUTDOOR EXTENSION CORD.** For 3-wire power tools and appliances. 079384, 03354 13-K

**100' CORD.** 03302, 079392 13-L **13.99**



EVEREADY

**1.29**

**SQUEEZE LIGHT.** High intensity, disposable pocket flashlight. Powered by Energizer batteries. 4212BP 13-M



**VALUABLE COUPON**

© CAROL EACH With Coupon

**1.59**

**16' 3-OUTLET CUBE TAP EXTENSION CORD.** Tough, versatile, virtually unbreakable. Brown or white. 13-N

Coupon Good Through Sale Only.

**CLIP & SAVE**

13

Mayfair.

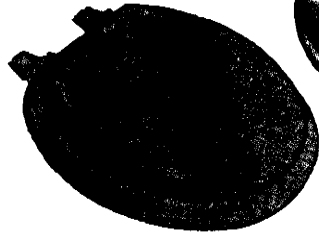

**5.99**

**WOODEN TOILET SEAT.** Finished with multiple coats of baked enamel. 66-TT 14-A

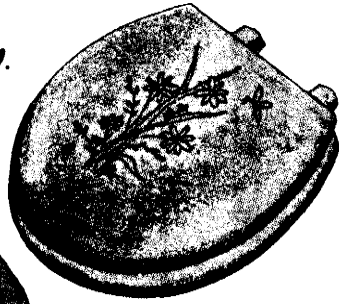

**9.99**

**SOFT TOILET SEAT.** Easy to clean vinyl. Quick to install. Available in assorted colors. 13-D 14-B

sinkmaster

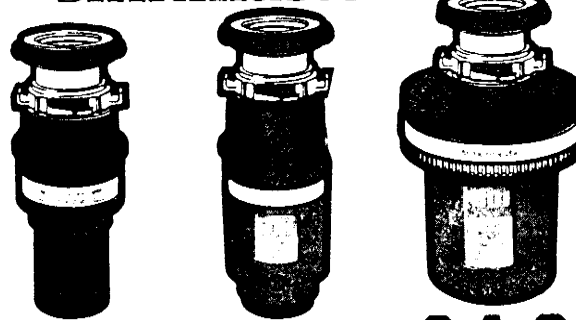

**SINKMASTER GARBAGE DISPOSALS.** 1/3 HP CORROSION-PROOF. Grinding chamber, stainless steel swivel impellers. 1 year warranty. 401, 158014 14-C

**34.99**

1/2 HP STAINLESS STEEL. Grind ring swivel impellers. Corrosion proof grinding chamber. 2 year warranty. 701, 158022 14-D

**49.99**

1/2 HP HEAVY DUTY. Fully-insulated sound shell, all stainless steel grinding components and corrosion proof grinding chamber and drain housing. 2 year warranty. 801, 158030 14-E

**69.99**

WE'RE THE PROBLEM SOLVERS

**HYC**  
SINCE 1947  
**ALUMINUM**  
Chimney Covers

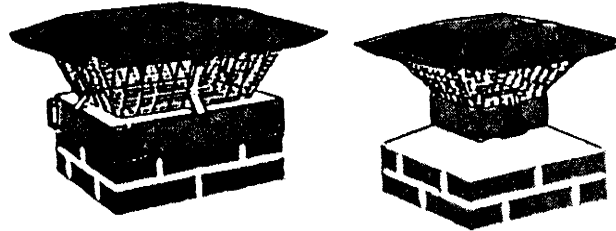

Keep rain, & birds out. Reduce chimney repairs. These long lasting units are designed with both quality and price in mind. They are completely maintenance free. Install it and forget it. We have most sizes in stock. 14-F

TILE SIZES		
216894 9x9	217026 9x13	217034 13x13
<b>5.84</b>	<b>10.97</b>	<b>18.84</b>



**WRAP-ON® 2.49**

**FIBERGLASS PIPE INSULATION.** For insulating heat tapes and hot or cold pipes. Can also be used for caulking. 16503 14-G



**PIPE-GUARD**

**5.99**

6' WRAP-ON® PIPE GUARD. Prevent frozen water pipes. Automatic heat tapes for rigid CPVC and metal pipes. Provides pipe protection...economically. Factory tested 5 times. 065276 14-H  
13' 065309 14-I **6.99**

**VALUABLE COUPON**

**Facet**

**69¢** With Coupon

**LIMIT 6** FURNACE FILTER. Available in popular 1" thick sizes. 14-J

Coupon Good Through Sale Only.

**CLIP & SAVE**

**Cut Heat Loss up to 80%** climatube 80 PIPE INSULATION

**Stop Pipe Sweating**

5/8" Wall Thickness

FOUR 3' LONG PIPE COVERS. Closed cell insulation helps prevent pipes from freezing. Cuts easily for quick installation. 5/8" thick.

1/2" SIZE CL-50 14-K **3.59**

3/4" SIZE CL-75 14-L **4.49**



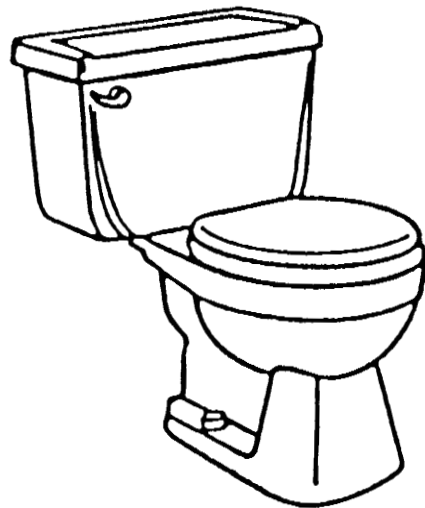

**39.99**

WHITE TOILET TANK & BOWL. Seat not included. 15-A

PEERLESS FAUCET

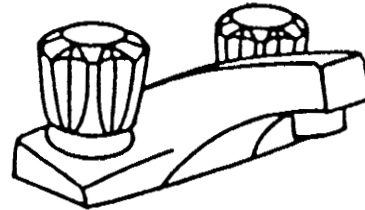

**19.97**

BATH FAUCET. Double handles. 221044, 9611 15-B

AMERICAN CRAFT.

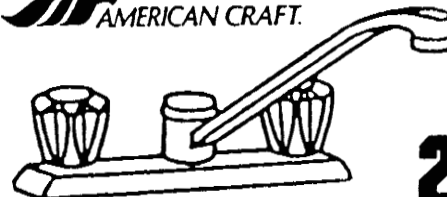

**24.97**

KITCHEN FAUCET. Double handles. 221010, 9211 15-C

**PLUMBING SUPPLY SALE**

PLUMD SHOP.

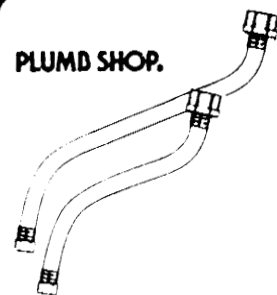

12" FLEXIBLE WATER SUPPLY LINES. Reinforced for superior strength. Won't rust or corrode.

SINK SUPPLY PS130, 318436 15-D **2.49**

TOILET SUPPLY PS156, 318535 15-E **2.99**

GREAT VIBRATIONS



**12.99**

THE ORIGINAL MODEL B253N. Pulsating massage spray stimulates, soothes & massages. Full cone regular spray, fully adjustable from drenching shower to fine needle. 268219 15-F

DO-IT-YOURSELF WITH NEPTUNE STAINLESS STEEL SINKS

You'll have the look you want for years to come when you install a Neptune stainless steel sink.

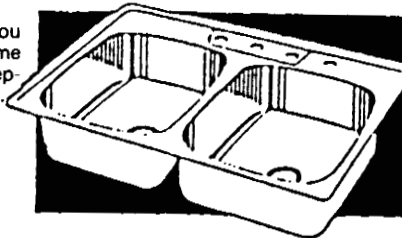

GOOD SERIES-Model NE-3322. 33" x 22" double bowl. 6 1/8" deep bowls. Durable buffed finish. 3-year limited warranty. 167296 15-G

**34.97**

BETTER SERIES-Model N-3322. 33" x 22" extra capacity bowl. 7" deep bowls. Brilliant finish with highlighting. 7-year limited warranty. 167320 15-H

**49.97**

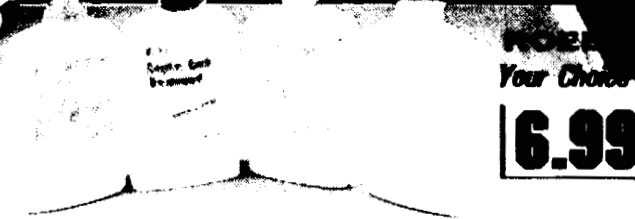

POWER Your Choice

**6.99**

DRAINPIPE CLEANER. Keeps pipes clear. 26oz. K-67 15-K  
SEPTIC TANK TREATMENT. Prevents clogging for one full year. 1 quart. K-37 15-L  
TANK & CESSPOOL CLEANER. Ends sluggishness, restores efficiency. 1 quart. K-57 15-M  
ROOT KILLER. Keeps pipes free from roots. 2 lbs. K-77 15-N

JUST WORKS. COUPON

VALUABLE COUPON



With Coupon **1.49**

KWIK SEAL TUB AND TILE CAULK. Makes a neat, white, watertight seal around tubs, sinks, shower stalls. Resets loose tile. Stays flexible. Resists mildew. Takes paint. 18003, 100784 15-O

Coupon Good Through Sale Only

CLIP & SAVE

15

**TRUST WORTHY HOME CENTERS**

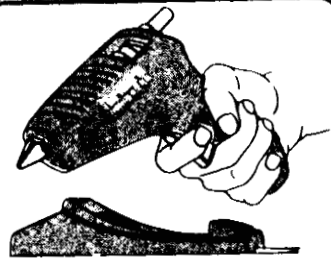

**EMHART THERMOSTRIP CORDLESS GLUE GUN.** No cord to get in the way. Comes with charging stand. "Dual Connect" system gives option of using cord for big gluing jobs. **18.99**  
T.G.C. 16-A

**NEW FROM CHAMBERLAIN**

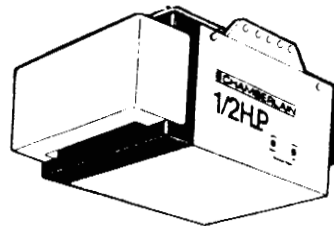

**AT A SURPRISINGLY LOW PRICE**

**149.99**

**1/2 HP GARAGE DOOR OPENER.** 1/2 HP motor with industrial strength chain drive and durable steel construction. 4 1/2 minute light delay. Illuminated pushbutton control. 6,561 security codes.

450 16-G



**1.49**

**1/4" X 50'.** A popular natural fiber rope with many uses in the home, business and as an all purpose tie-down rope. **219253 16-B**



**99¢**

**10.5 Oz. LIQUID NAILS.** Waterproof bond remains elastic on most building materials. **LN-601-B 16-C**

**JET VAC**



5 Gal.  
060-481  
16-G

**39.99**

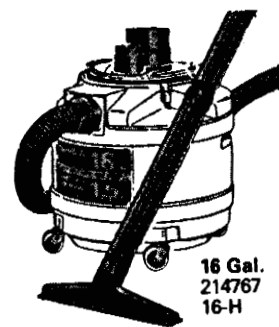

16 Gal.  
214767  
16-H

**79.99**

**WET/DRY SHOP VACUUM.** Cleans up wet basements, garage and workshop debris, laundry room spills, sawdust, dirt and much more. Rugged non-metallic body...never rusts or dents. Washable, reusable filter. Powerful motors. One-year limited warranty/ U.L.® LISTED and C.S.A. certified.

This is a syndicated publication. All prices are suggested retail prices, merely a general indication of value, and are not binding on the dealer. This distributing dealer is an independent merchant who has the option to sell at prices set by him that will be competitive in his local trade area. The participating dealer's ability to stock all items during the sales period is dependent upon the availability of merchandise from the manufacturer. The dealer reserves the right to limit quantities and to substitute items of equal or better quality. Not responsible for printing errors. Distributed by L. G. Cook Dist.



**CROFT-CLARA LUMBER**

6141 E. CASS CITY RD., CASS CITY, MI  
(517) 872-2141

HOURS: MON.-THURS. 8-5:30, FRI. 8-8, Sat. 8-3

**CASH & CARRY ONLY**



78-024 88-8